



District Heating Controller

for 1 heating circuit and d.h.w. heating

RVD120

RVD140

Multifunctional heating controller for use in district heating substations and district heating plants with Modbus communication. Suited for one heating circuit with d.h.w. heating in instantaneous systems or with storage tank. Eight programmed plant types. Operating voltage AC 230 V.

Use

- Plant:
Heat exchanger in the district heating substation
- Buildings:
Residential and non-residential buildings with own district heating connection and d.h.w. heating
- Types of space heating systems:
All common heating systems, such as radiator, convector, underfloor and ceiling heating systems, or radiating panels
- Types of d.h.w. heating systems:
 - D.h.w. storage tanks or instantaneous systems
 - Common or separate heat exchangers for heating circuit and d.h.w. heating
 - D.h.w. heating with electric immersion heater and solar collector

Functions

- Heating circuit control**
- Weather-compensated flow temperature control, mixing valve with 3-position actuator
 - Weather-compensated flow temperature control with room temperature influence, mixing valve with 3-position actuator
 - Room temperature-compensated flow temperature control, mixing valve with 3-position actuator
 - Demand-dependent control of the common flow

- D.h.w. heating**
- D.h.w. heating via heat exchangers in storage tanks
 - Instantaneous d.h.w. heating via heat exchanger with or without mixing valve in the secondary circuit
 - D.h.w. heating with electric immersion heater and solar collector

- Additional functions**
- Quick setback
 - Automatic heating limit (ECO function)
 - Frost protection (for the building, plant, and d.h.w.)
 - Annual clock for annual holidays, with automatic summer-/wintertime changeover
 - Independent time switch programs for room heating and d.h.w.
 - Pump kick
 - Idle heat function in the case of instantaneous d.h.w. heating via the parallel heat exchanger
 - Flow switch with adjustable load limit, protection against tampering and adaptation to the seasons
 - Maximum limitation of return temperature differential (DRT-limitation)
 - Relay and sensor tests
 - Remote operation via room unit
 - Refill function
 - Communication via Modbus

Type summary

<i>Description</i>	<i>Documentation in languages</i>	<i>Key feature</i>	<i>Product no.</i>	<i>Stock number</i>
District heating and d.h.w. controller	German, French, English, Italian, Danish, Finnish, Swedish	Supports plant types no. 1...3	RVD120-A	S55370-C109
District heating and d.h.w. controller	Polish, Czech, Greek, Russian, Bulgarian, Romanian		RVD120-C	S55370-C110
District heating and d.h.w. controller	German, French, English, Italian, Danish, Finnish, Swedish	Supports plant types no. 1...8	RVD140-A	S55370-C113
District heating and d.h.w. controller	Polish, Czech, Greek, Russian, Bulgarian, Romanian		RVD140-C	S55370-C114

Ordering

When ordering, give the **Product no.** according to "Type summary" and the **Language code letter** (-A or -C) for the operating instructions and the installation instructions in the requested language.

Examples: RVD120-A for English; RVD140-C for Polish

Sensors, room unit, actuators and valves must be ordered as separate items.

Product documentation

Type of documentation	Classification number	Part number
Basic Documentation	P2510	–
Operating instructions (languages: de, en, fr, it, da, fi, sv)	B2510	74 319 0683 0
Operating instructions (languages: pl, cs, el, ru, bu, ro)	B2510	74 319 0684 0
Installation instructions (languages: de, en, fr, it, da, fi, sv)	G2510	74 319 0681 0
Installation instructions (languages: pl, cs, el, ru, bu, ro)	G2510	74 319 0682 0
CE Declaration of Conformity	T2510	–
Environmental Declaration	E2510	–

Equipment combinations

Suitable sensors and room units

- Flow, return and d.h.w. temperature: All sensors with sensing element LG-Ni 1000, for example:
 - Strap-on sensor QAD22
 - Immersion sensor QAE212... and QAP21.3
 - Collector sensor (solar) QAP21.2
- Room temperature:
 - Room unit QAW50 and QAW70
 - Room sensor QAA10
- Outdoor temperature:
 - Outside sensor QAC22 (LG-Ni 1000 sensing element)
 - Outside sensor QAC32 (NTC measuring element)
- Pressure: sensor with output signal DC 0...10 V:
 - Pressure sensor QBE2002...

Suitable actuators

All electromotoric and electrohydraulic actuators for 3-position control and with an operating voltage AC 24...230 V made by Siemens can be used.

Communication

Plants can be remotely monitored, read and operated via Modbus RTU. An appropriate master is required as communications partner. The controllers communicate as slaves via Modbus RTU.

The Basic Documentation P2510 includes a table with all Modbus data points.

Technical design

Functioning

- Controller RVD120 has 3 plant types preprogrammed
- Controller RVD140 has 8 plant types preprogrammed

When commissioning the system, the respective plant type must be selected. The required functions, settings and displays will then be automatically assigned. The parameters not required for the plant in question will not be shown.

Optional functions must be configured as such.

Plant types

	<p>Plant type no. 1 – RVD120 and RVD140 Heating circuit control without d.h.w. heating RVD140: Refill function optional</p>
--	--

	<p>Plant type no. 2 – RVD120 and RVD140</p> <p>Heating circuit control with d.h.w. heating (storage tank). RVD140: Circulating pump, refill function, electric immersion heater and solar d.h.w. heating pump optional</p>
	<p>Plant type no. 3 – RVD120 and RVD140</p> <p>Heating circuit control with d.h.w. heating (storage tank). RVD140: Circulating pump, refill function, electric immersion heater and solar d.h.w. heating optional</p>
	<p>Plant type no. 4 – only RVD140</p> <p>Separate heat exchangers for heating circuit and d.h.w. heating (instantaneous system). Sensor B71:</p> <ul style="list-style-type: none"> • as a d.h.w. sensor, or • for DRT function <p>Circulating pump, flow switch and refill function optional. Selectable idle heat function.</p>
	<p>Plant type no. 5 – only RVD140</p> <p>Separate heat exchangers for heating circuit and d.h.w. heating, 2-stage d.h.w. control: 1st stage in the primary return, 2nd stage with mixing valve in the secondary flow. Flow switch, refill function and externally controlled circulating pump optional. Selectable idle heat function.</p>
	<p>Plant type no. 6 – only RVD140</p> <p>Separate heat exchangers for heating circuit and d.h.w. heating. Instantaneous storage tank connected to separate heat exchanger, d.h.w. charging with charging pump. Sensor B71:</p> <ul style="list-style-type: none"> • as a d.h.w. sensor, or • for DRT function <p>Circulating pump, refill function, electric immersion heater and solar d.h.w. heating optional.</p>
	<p>Plant type no. 7 – only RVD140</p> <p>Two heat exchangers connected in series for heating circuit and d.h.w. heating. Instantaneous storage tank connected to the second heat exchanger, with mixing valve control for d.h.w. Sensor B71:</p> <ul style="list-style-type: none"> • as a d.h.w. sensor, or • for DRT function <p>Refill function, electric immersion heater, solar d.h.w. heating and externally controlled circulating pump optional.</p>

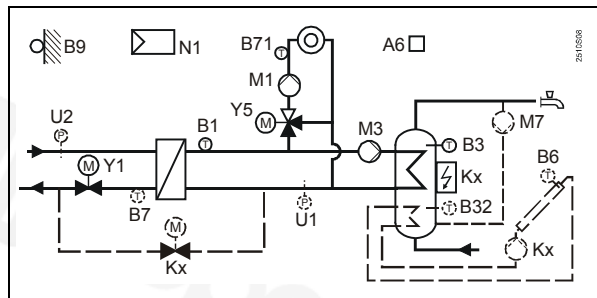





Plant type no. 8 – only RVD140
 Heating circuit control with d.h.w. heating. Heating circuit with mixing valve control, storage tank with charging pump.
 Circulating pump, refill function, electric immersion heater and solar d.h.w. heating optional.

- | | |
|---|---|
| A6 Room unit / room sensor | M1 Heating circuit pump |
| B1 Flow sensor (controlled variable) | M3 D.h.w. charging pump |
| B3 D.h.w. sensor / storage tank sensor 1 | M7 Circulating pump (only with RVD140) |
| B32 Storage tank sensor 2 (only with RVD140) | M External circulating pump |
| B6 Collector sensor (only with RVD140) | N1 Controller |
| B7 Primary return sensor | U1 Secondary pressure sensor (only with RVD140) |
| B71 Universal sensor | U2 Primary pressure sensor (only with RVD140) |
| B9 Outside sensor | Y1 Two-port valve in the primary return |
| H5 Flow switch (only with RVD140) | Y5 Two-port valve / mixing valve |
| Kx Multifunctional output K6 or K7 (only with RVD140) | Y7 Changeover valve / mixing valve |

Heating circuit control

Operating modes

- Auto  **Automatic operation**
 Automatic heating according to the time switch program, automatic ECO function and room unit active
-  **Continuous operation**
 Heating with no time switch program, setpoint adjustment with the setting knob
-  **Protection**
 Heating off, frost protection ensured
-  **Automatic d.h.w. heating**
-  **Manual operation**
 No control, circulating pumps in service

Frost protection is ensured in all operating modes.

Acquisition of measured values

- Flow sensor: LG-Ni 1000
 - Outside sensor: LG-Ni 1000 or NTC 575
 - Pressure sensor: DC 0...10 V
 - Primary return sensor: LG-Ni 1000
 - Room temperature: With PPS-room unit or PPS-room sensor
- If different types of sensors are used, the controller automatically identifies the type of sensor connected.

Compensating variables

With weather-compensated control systems, the composite outside temperature is used as the compensating variable. It is generated from the actual and the attenuated outside temperature (calculated by the controller). Consideration is given to the type of building construction (adjustable for light and heavy buildings).

Setpoints

- The following setpoints can be adjusted:
- Nominal room temperature
 - Reduced room temperature
 - Room temperature for frost protection

Generation of flow temperature setpoint	<ul style="list-style-type: none"> • Weather-compensated control: The flow temperature setpoint is controlled in function of the prevailing outside temperature via the heating curve • Weather-compensated control with room temperature influence: The flow temperature setpoint is controlled in function of the prevailing outside temperature and, in addition, in function of the deviation of the actual room temperature from the setpoint • Room temperature-compensated control: The setpoint is controlled in function of the deviation of the actual room temperature from the setpoint
Control	The controlled variable is always the secondary flow temperature. In all types of plant, it is controlled through a two-port valve in the primary return depending on the plant's total demand for heat (space heating plus – if present – d.h.w. heating).
Maximum limitation of return temperature	The valve in the primary circuit starts traveling towards the closed position when the limit value is exceeded. The characteristic is constant-shifting depending on the outside temperature.
Quick setback	<p>When changing from the normal temperature to a lower temperature level (☾ or ☺), the heating will be shut down.</p> <ul style="list-style-type: none"> • If there is a room sensor present, it will be switched on again when the setpoint of the lower temperature level is reached • If there is no room sensor present, quick setback is active during a defined period of time, which depends on the type of building construction and an adjustable gain factor. The function can be deactivated, if required
Automatic ECO function	<p>With the automatic ECO function, the heating is controlled depending on demand. The heating will be shut down if permitted by the outside temperature. Consideration is given to the actual, the attenuated and the composite outside temperature, as well as to an adjustable heating limit.</p> <p>The ECO function requires the use of an outside sensor. It can be deactivated, if desired.</p>
Maximum and minimum limitation of flow temperature	<p>Both limitations are accomplished via the heating curve. When the limit value is reached, the heating curve assumes a constant value. Any active limitation is shown on the display.</p> <p>Both limitations can be deactivated.</p>
DRT function	The differential between the primary and the secondary return temperature is limited to a maximum value.
Time switch programs	To provide automatic operation of the heating system, the controller RVD120/140 features a weekly program with 3 heating periods that can be adjusted on a daily basis. Another weekly program is available for the release of d.h.w. charging.
Pump kick	<p>The pump kick is adjustable for the heating circuit pump, the d.h.w. charging pump, the collector pump and the circulating pump. The pump kick is made once per week and lasts 30 seconds.</p> <p>The function can be deactivated, if required.</p>

Heating curve

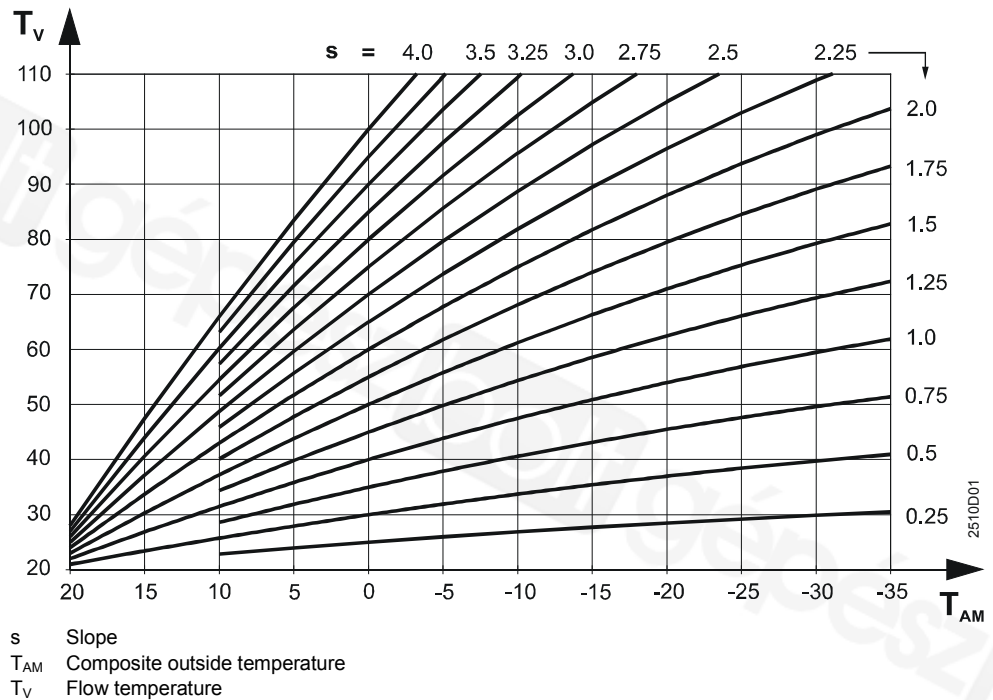

Relay and sensor tests

To facilitate commissioning and fault tracing, both relay and sensor tests can be made:

- Relay test: each of the relays can be manually energized
- Sensor test: all sensor values can be interrogated

Pulse lock with actuators

The total duration of the closing pulses delivered to an actuator is limited to five times the actuator's running time, in order to extend the life of the relay contacts.

Raising the reduced room temperature

The setpoint of the reduced room temperature can be raised as the outside temperature falls. The increase (effect) is adjustable. This function can be deactivated, if required.

Frost protection for the building

Frost protection for the building ensures an adjustable minimum room temperature. This function cannot be deactivated.

Frost protection for the plant

Frost protection for the plant protects the heating plant against freeze-ups through activation of the heating circuit pump. This function can be provided with or without an outside sensor:

- With outside sensor:
 - Outside temperature ≤ 1.5 °C: the heating circuit pump runs for 10 minutes at 6-hour intervals
 - Outside temperature ≤ -5 °C: the heating circuit pump runs continuously
 - Without outside sensor:
 - Flow temperature ≤ 10 °C: the heating circuit pump runs for 10 minutes at 6-hour intervals
 - Flow temperature ≤ 5 °C: the heating circuit pump runs continuously
- This function can be deactivated, if required.

Refill function

The controller RVD140 supports the refill function to maintain the secondary side plant pressure.

If it drops below a minimum value, water – from the primary side or from a separate tank – is refilled in the secondary plant circuit to increase the pressure.

D.h.w. heating

In addition to heating circuit control, the RVD120/140 provide control of d.h.w. heating in the following types of plant and d.h.w. systems:

<i>Plant type no.</i>	<i>RVD120</i>	<i>RVD140</i>	<i>D.h.w. system</i>
1	●	●	–
2	●	●	Storage tank connected to common heat exchanger
3	●	●	Storage tank connected to common heat exchanger
4		●	Instantaneous system connected to a parallel heat exchanger
5		●	Instantaneous system connected to a parallel heat exchanger
6		●	Instantaneous storage tank connected to a parallel heat exchanger
7		●	Instantaneous storage tank connected to common heat exchanger
8		●	Storage tank connected to common heat exchanger

Acquisition of measured values

The acquisition of the d.h.w. temperature is provided with sensors LG-Ni 1000 connected to terminals B3, B32 and B71.

D.h.w. functions with all types of plant

- Settings: Normal setpoint and reduced setpoint, maximum setpoint, setpoint boost and switching differential
- Frost protection for d.h.w.: a minimum temperature of 5 °C is always maintained
- D.h.w. OFF: d.h.w. heating can be manually switched off
- Maximum limitation of the primary return temperature: adjustable is a limit value independent of heating circuit control

Plant type-specific d.h.w. functions

- Release:
With plant types no. 2...8, release of d.h.w. heating can be selected:
 - According to own d.h.w. time switch program
 - During the controller's heating periods, with or without forward shift of the first daily release
 - Always (24 hours per day)
- Priority: the behavior of the heating circuit during d.h.w. charging can be selected:
 - Absolute: heating circuit pump deactivated (plant type no. 8: mixing valve fully closed, heating circuit pump remains activated)
 - Shifting: heating circuit pump remains activated as long as there is sufficient heating energy available (plant type no. 8: mixing valve throttled). The d.h.w. setpoint or maximum setpoint is maintained
 - Parallel: no priority; heating circuit remains ON. The d.h.w. setpoint or maximum setpoint is maintained
- Idle heat function: in instantaneous systems, the heat exchanger's primary side is periodically heated up
- Flow switch: to improve the heat exchanger's control performance, with adjustable load limit, adapts to the seasons, tamperproof (prevents the control system from responding too frequently).
- Forced charging: d.h.w. charging takes place every day on the first release (or at midnight with the 24-hour program). It also takes place if the actual value lies within the switching differential
- Manual charging:
 - Independent of the time switch program and temperature conditions
 - During protection mode
- D.h.w. heating with electric immersion heater or solar collector:
In plant types with d.h.w. storage tank, one of the two multifunctional relays of the RVD140 can be parameterized for d.h.w. heating using an immersion heater or a solar collector

Extra functions

Remote operation via room units

- Room unit QAW50: changeover of operating mode, room temperature setpoint adjustments and room temperature readjustments
- Room unit QAW70: overriding the setpoints and the heating program, entry of holiday periods

Parameter reset

All settings made can be reset to the factory settings.

Manual operation

In manual operation, the heating can be controlled manually. In that case, d.h.w. heating will be shut down and the relays switched as follows:

- Actuator of primary return valve: no power supply, but can be manually controlled from the controller
- Other actuators: fully closed, no power supply
- Heating circuit pump: activated
- D.h.w. charging pump, collector pump and circulating pump: activated
- Electric immersion heater: released

Mechanical design

Controller

The RVD120/140 is comprised of controller insert and base.

The controller insert accommodates the electronics, the power section, the output relays and – on the front of the unit – the LCD featuring background lighting and all operating elements.

Two screws are used to secure the controller insert to the base, which carries the connection terminals.

The RVD120 contains four relays, the RVD140 nine.

The controller can be mounted in three different ways:

- Wall mounting (on a wall, in a control panel, etc.)
- Top hat rail mounting
- Flush panel mounting (compact station, control panel front, etc.)

Display and operating elements

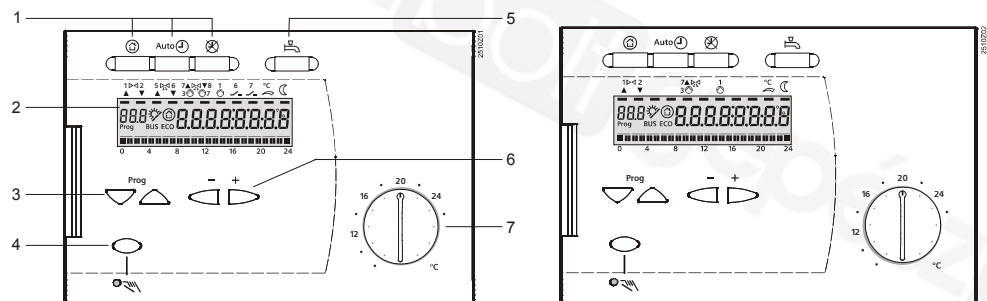

Front view of RVD140

Front view of RVD120

- 1 Operating mode buttons
- 2 Display (LCD)
- 3 Buttons for selecting operating lines
- 4 Button for manual operation ON / OFF
- 5 Button for d.h.w. heating ON / OFF
- 6 Buttons for making readjustments of values
- 7 Setting knob for nominal room temperature setpoint

Operation

Analog operating elements

- Buttons for selecting the required operating mode and for d.h.w. ON / OFF
- Setting knob for the room temperature setpoint in continuous operation
- Button for manual operation

The entry or readjustment of all the other setting parameters, activation of optional functions, and reading of actual values and statuses is made using the operating line principle. An operating line with an associated number is assigned to each parameter, each actual value and each function that can be selected. One pair of buttons is used to select an operating line and one pair to readjust the display.

These buttons are located behind a hinged cover. The operating instructions are inserted at the rear of the cover.

Notes

Engineering

- The wires of the measuring circuits carry extra low voltage
- The wires to the actuator and the pumps carry AC 24...230 V
- The local regulations for electrical installations must be complied with
- Sensor cables may not be run parallel to mains carrying cables for loads such as actuators and pumps (safety class II to EN 60730)
- In control systems using a room sensor, the reference room may not be equipped with thermostatic radiator valves. Manual valves must be locked in their fully open position
- Local regulations as well as requirements of the district heat supplier when using the refill function must be complied with

Mounting

- Suitable mounting locations are compact stations, control panels, control desks or the heating room. Not permitted are wet or damp locations
- Mounting methods: wall, top hat rail or panel cutout
- Cable tension relief must be ensured
- Cable glands made of plastic must be used
- All terminals for extra low voltage (sensors and room unit bus) are located in the upper section of the terminal compartment, those for mains voltage (actuators and pumps) in the lower section

Commissioning

- The plant type must be selected
- The settings of the district heating parameters can be locked
- The controller is supplied complete with mounting and commissioning instructions

Disposal



The devices are considered electronics devices for disposal in terms of European Directive 2012/19/EU and may not be disposed of as domestic garbage.

- Dispose of the devices through channels provided for this purpose.
- Comply with all local and currently applicable laws and regulations.

Warranty

When using the RVD120/140 together with third-party devices not specifically mentioned, correct functioning must be ensured by the user. In that case, Siemens will assume no responsibility for service and warranty.

Technical data

Power supply	Operating voltage	AC 230 V (+10 / -15 %)
	Frequency	50 Hz
	Power consumption (no external load)	RVD120: max. 5.5 VA RVD140: max. 6.5 VA
	External supply line protection	Slow-blow fuse max. 10 A or Circuit breaker max. 13 A Characteristic B, C, D according to EN 60898
	<hr/>	
Inputs		
Sensor inputs (B...)	Sensing elements	refer to sections "Acquisition of measured values"
<hr/>		
Digital input (H5)	Voltage with contact open Current with contact closed Contact resistance	DC 12 V DC 3 mA R ≤ 80 Ω
<hr/>		
Analog inputs (U...)	Operating range Input resistance	DC 0...10 V R > 100 kΩ
<hr/>		
Relay outputs	Rated switching voltage	AC 24...230 V
	Rated current Y1, Y2, Q1, K6, K7	AC 0.02...1(1) A
	Rated current Y5, Y6, Q3/Y7, Q7/Y8	AC 0.02...2(2) A
	Switch-on current	max. 10 A max. 1 s
	Max. rating as mixing valve relay	15 VA
	External supply line protection	See section power supply
<hr/>		
Interfaces		
Modbus RTU	Basic system	RS485 (EIA-485). For details, refer to the modbus specification
	Connection Bus terminator (not included in delivery)	2-wire, twisted pairs, shielded terminating resistor 150 Ω (0.5 W) for the first and last device on the bus
<hr/>		
PPS	Connection (room unit or room sensor)	2-wire, interchangeable
<hr/>		
Permissible cable lengths	For all sensors	
	Copper cable, 0.6 mm dia.	20 m
	Copper cable, 1.0 mm ²	80 m
	Copper cable, 1.5 mm ²	120 m
	<hr/>	
	For the room units (PPS)	
	Copper cable, 0.25 mm ²	25 m
Copper cable, from 0.5 mm ²	50 m	
<hr/>		
For the data bus (Modbus)		
Copper cable, from 0.25 mm ²	1000 m	
<hr/>		
Connection terminals	Screw terminals	for wire section up to 2.5 mm ²
<hr/>		
Backup	Backup of controller clock	12 h
<hr/>		

Standards, directives and approvals	Product standard	EN 60730-1	Automatic electrical controls for household and similar use	
	Electromagnetic compatibility (Applications)		For use in residential, commerce, light-industrial and industrial environments	
	EU conformity (CE)		CE1T2510xx *)	
	RCM-conformity (EMC)		CE1T2513en_C1 *)	
	EAC conformity		Eurasia conformity	
Environmental compatibility	Product environmental declaration (contains data on RoHS compliance, materials composition, packaging, environmental benefit, disposal)		CE1E2510 *)	
Eco design and labeling directives			Class	Efficiency gain
	Application with one room temperature sensor and one outdoor temperature sensor and modulating control		VI	4.0%

*) The documents can be downloaded from <http://siemens.com/bt/download>.

Classifications to EN 60730	Software class	A		
	Mode of operation	type 1B (automatic controls)		
Safety data	Safety class	II to EN 60730 (when correctly installed)		
	Degree of protection	IP 40 to EN 60529 (when correctly installed)		
	Degree of contamination	2 to EN 60730		
Dimensions		refer to "Dimensions"		
Weight	Unit (net)	RVD120:	0.74 kg	
		RVD140:	0.84 kg	
Colors	Controller insert	light grey RAL 7035		
	Terminal base	pigeon blue RAL 5014		
Environmental conditions		<i>Operation</i> EN 60721-3-3	<i>Transport</i> EN 60721-3-2	<i>Storage</i> EN 60721-3-1
	Climatic conditions	class 3K5	class 2K3	class 1K3
	Temperature	0...+50 °C	-25...+70 °C	-20...+65 °C
	Humidity	<95 % r.F. (non-condensing)	<95 % r.F.	<95 % r.F. (non-condensing)
	Mechanical conditions	class 3M2	class 2M2	class 1M2
	Use above sea level	max. 3000 m above sea level		

Connection diagrams

Low voltage side

RVD120

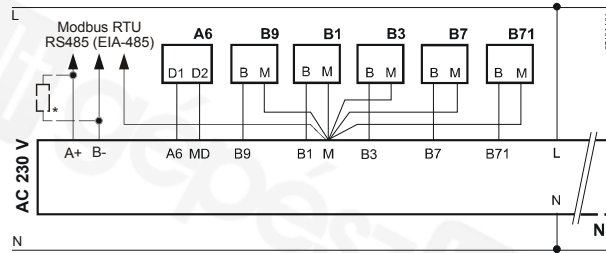

RVD140

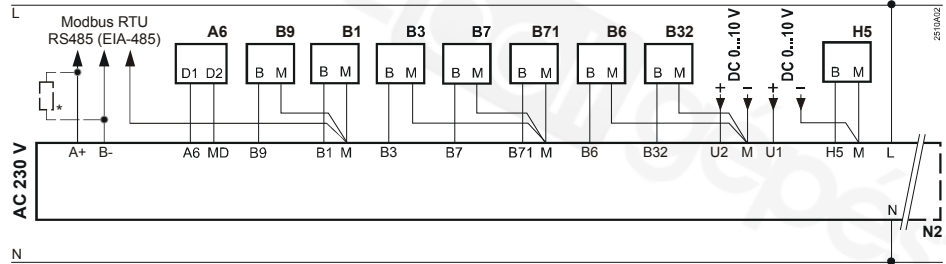

* Terminating resistor 150 Ω (0.5 W) for the first and last device on the bus.
See Modbus specification for details

Mains voltage side

RVD120

(Plant types no. 1, 2, 3)

1 actuator and 2 pumps or
1 actuator, 1 pump and
1 changeover valve

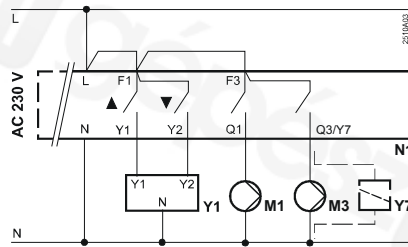

RVD140

(Plant type no. 5)

3 actuators and 1 pump

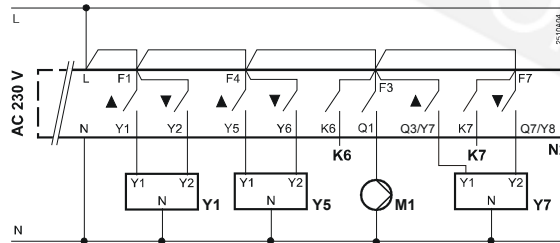

RVD140

(Plant types no. 1, 2, 3,
4, 6, 7, 8)

2 actuators and 3 pumps or
2 actuators, 2 pumps and
1 changeover valve

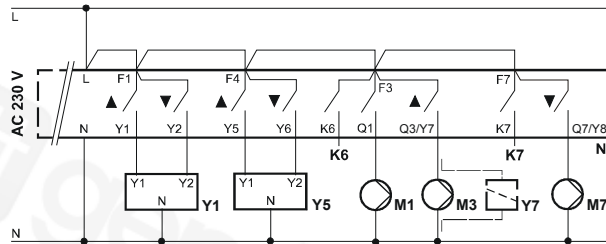

A6	Room unit / sensor	M1	Heating circuit pump
B1	Flow sensor	M3	D.h.w. charging pump
B3	D.h.w. sensor / storage tank sensor 1	M7	Circulating pump
B32	Storage tank sensor 2	Modbus RTU	Data bus
B6	Collector sensor	N1	Controller RVD120
B7	Primary return sensor	N2	Controller RVD140
B71	Universal sensor	U1	Secondary pressure sensor
B9	Outside sensor	U2	Primary pressure sensor
H5	Flow switch	Y1	Actuator of two-port valve in the primary return
K6 and K7	Multifunctional outputs for refill function / electric immersion heater / collector pump	Y5	Actuator of two-port valve / mixing valve
		Y7	Actuator of changeover valve / mixing valve

Dimensions

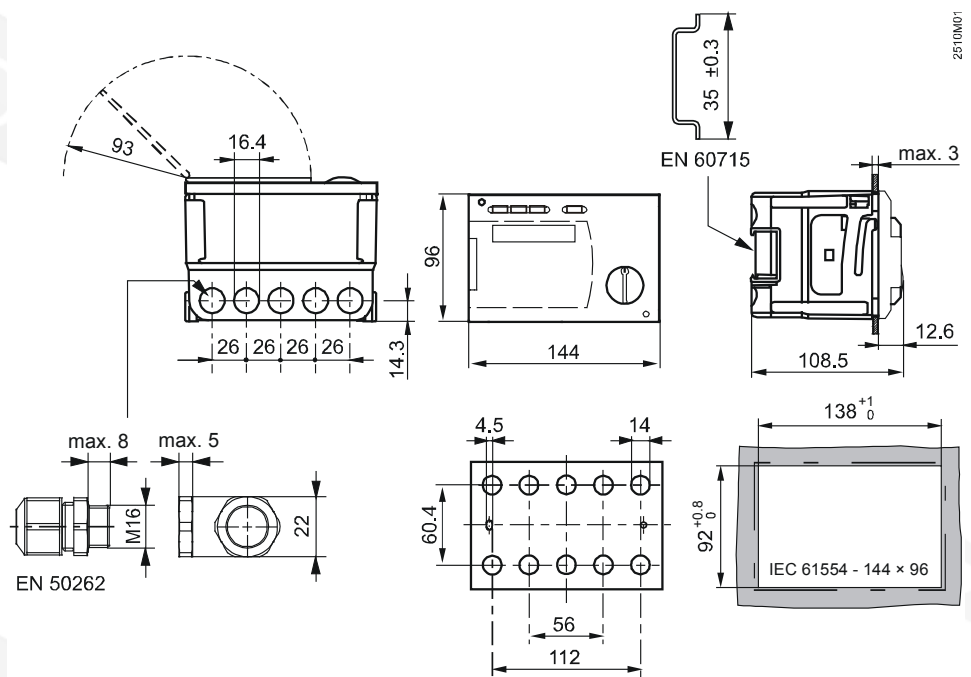

Dimensions in mm

Published by:
 Siemens Switzerland Ltd.
 Building Technologies Division
 International Headquarters
 Gubelstrasse 22
 6301 Zug
 Switzerland
 Tel. +41 41-724 24 24
www.siemens.com/buildingtechnologies

© Siemens Switzerland Ltd 2009
 Delivery and technical specifications subject to change