

<b>de</b>	Montageanleitung
<b>en</b>	Mounting instructions
<b>fr</b>	Instructions de montage
<b>sv</b>	Monteringsinstruktion
<b>nl</b>	Montage-handleiding
<b>it</b>	Istruzioni di montaggio
<b>fi</b>	Asennusohje
<b>es</b>	Instrucciones de montaje
<b>da</b>	Monteringsvejledning
<b>pl</b>	Instrukcja montażu
<b>cz</b>	Montážní návod
<b>hu</b>	Szerelési útmutató
<b>el</b>	Οδηγίες εγκατάστασης
<b>ru</b>	Инструкция по установке
<b>zh</b>	安装指导

<b>Stellantriebe</b>
<b>Actuators</b>
<b>Servomoteur</b>
<b>Ställdon</b>
<b>Servomotoren</b>
<b>Servocomandi</b>
<b>Toimimootorit</b>
<b>Actuadores</b>
<b>Motorer</b>
<b>Siłowniki</b>
<b>Pohony</b>
<b>Motorok</b>
<b>Κινητήρες</b>
<b>Приводы</b>
<b>执行器</b>

**SSA/SSB/SSP31..**  
**SSA/SSB/SSP81..**  
**SSA/SSB/SSP61..**

**SSA..**

**SSB..**

**SSP..**

**1**



**2**

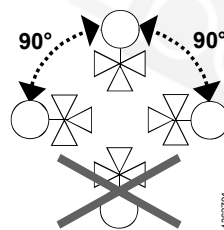

**3**

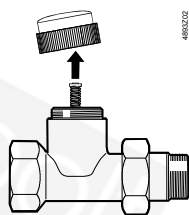

Siemens: VDN..., VEN..., VUN...,  
VPD..., VPE..., VD1...CLC, 2T...JA  
Honeywell, MNG, Cazzaniga, Heimeier, TA  
(TBV-C), Oventrop

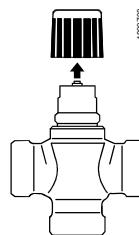

VVP45..<sup>1)</sup>  
VXP45..<sup>1)</sup>  
VMP45..  
<sup>1)</sup>  $k_{vs} \leq 6.3 \text{ m}^3/\text{h}$

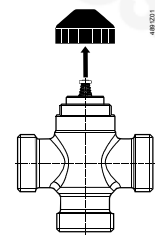

VVP47..  
VXP47..  
VMP47..

**4**

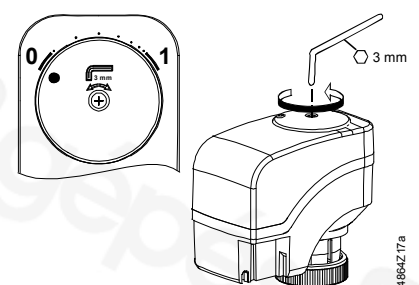
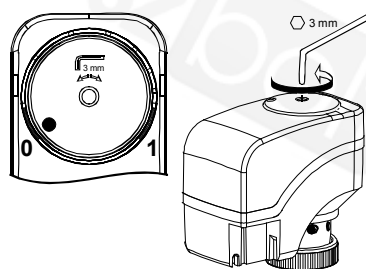
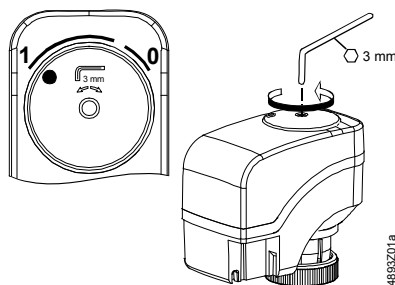

# SSA..

# SSB..

# SSP..

## 5

### AV..

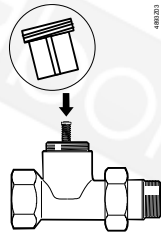

AV51	Beulco	M30x1
AV52	Comap	M28x1.5
AV53	Danfoss RA-N (RA 2000)	-
AV54	Danfoss RAVL	-
AV55	Danfoss RAV	-
AV56	Giacomini	-
AV57	Herz	M28x1.5
AV58	Oventrop < 2002	M30x1
AV59	Vaillant	-
AV60	TA (TBC) < 2002	M28x1.5
AV61	MMA Markaryd	M28x1.5

### AL100

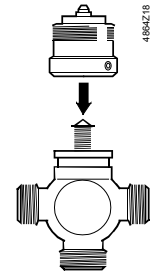

2W..  
3W..  
4W..

## 6

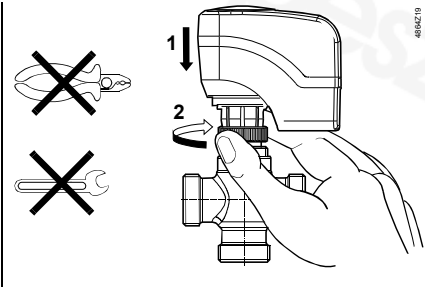
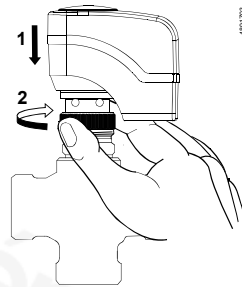
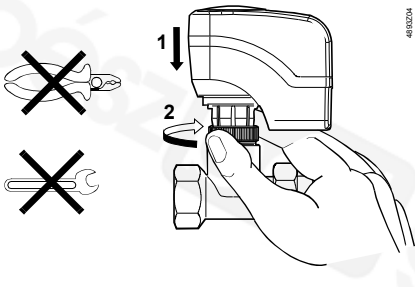

## 7

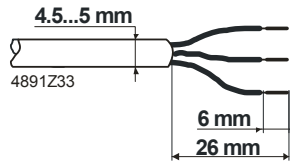
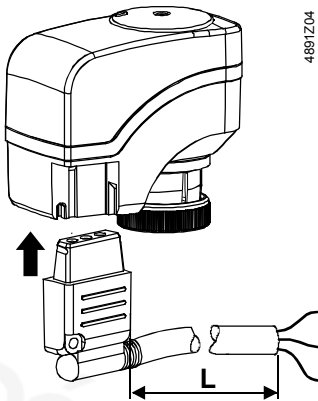

	N	G	G0
de	Neutralleiter	Systempotential	Systemnull
en	Neutral	System potential	System neutral
fr	Neutre	Potentiel du système	Zéro du système
sv	Nolledare	Systempotential	Systemnoll
nl	Nul	Systeem-potentiaal	Systeemnul
it	Neutro	Fase del sistema	Neutro del sistema
fi	Nollajohdin	Järjestelmäpotentiaali	Järjestelmänolla
es	Neutro	Fase CA para equipos	Neutro CA para equipos
da	Nulleder	System-fase	System-nul
pl	Przewód zerowy	Potencjał systemowy	Zero systemowe
cz	Nulový vodič	Systémový potenciál	Systémová nula
hu	Nulla (N)	Rendszer fázis	Rendszer nulla
el	Ουδέτερος	Φάση	Ουδέτερος
ru	Нейтраль	Системный потенциал	Системная нейтраль
zh	电源零线	额定电源	额定电源零线

## 8

ASY..	L [m]	SSD..		
ASY3L15	1.5	SSD31		Y2 = AC 230 V, 3-position
ASY3L25	2.5	SSD31/00		Y1 = AC 230 V, 3-position
ASY3L45	4.5			N = AC 230 V, neutral
ASY8L15	1.5	SSD81		Y2 = AC 24 V, 3-position
ASY8L25	2.5	SSD81/00		Y1 = AC 24 V, 3-position
ASY8L25B	2.5			G = AC 24 V, system potential (SP)
ASY8L45	4.5			
ASY8L45HF	4.5			
ASY6L15	1.5	SSD61, DC 0...10 V SSD61.2, DC 2...10 V		Y = DC 0/2...10 V, < 0.1 mA
ASY6L25	2.5	SSD61../00		G0 = AC/DC 24 V, system neutral (SN)
ASY6L45	4.5			G = AC/DC 24 V, system potential (SP)
ASY6L45HF	4.5			

9

ASY98

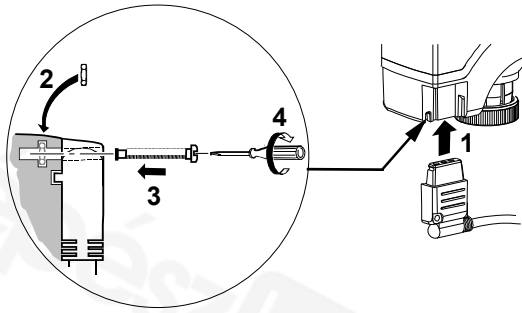

10

ASY99, ASY100

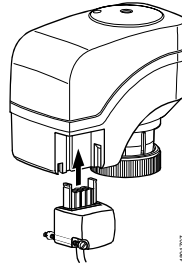
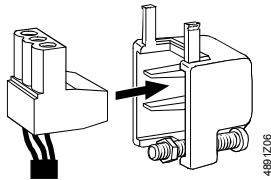

ASY99 → SSA81/00  
SSB81/00  
SSP81/00  
SSP81.04/00

ASY100 → SSA61/00  
SSB61/00  
SSP61/00



11

de	Hubkalibration
en	Stroke calibration
fr	Calibrage de la course
sv	Lyfthöjdskalibrering
nl	Slagcalibratie
it	Calibrazione corsa
fi	Iskunpituuden kalibrointi
es	Calibración de la carrera
da	Slaglængdekalibrering
pl	Kalibracja skoku
cz	Kalibrace zdvihu
hu	Lökettbeállítás
el	Διαμόρφωση διαδρομής εμβόλου
ru	калибровка хода
zh	行程校准

SSA61.., SSB61.., SSP61..:

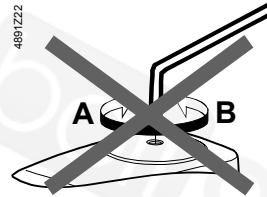
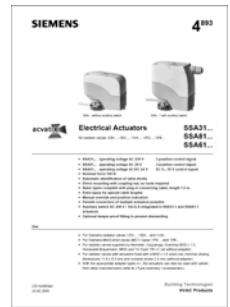

SSA.. N4893  
SSB.. N4891  
SSP.. N4864

11

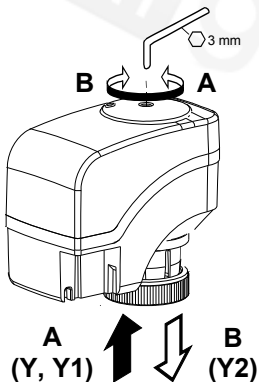
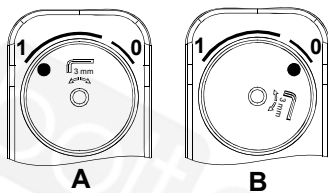

4893Z17

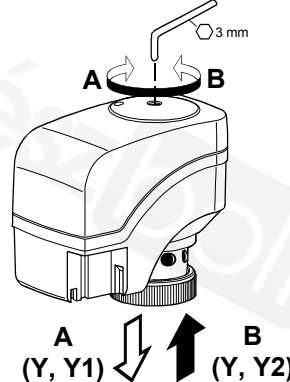
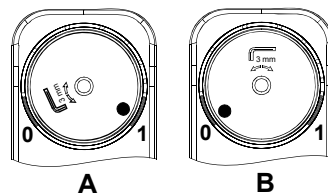

4891Z25

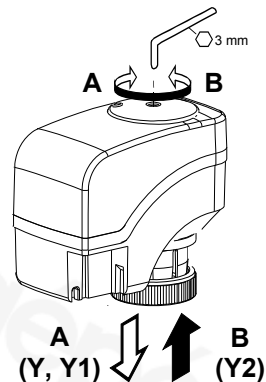
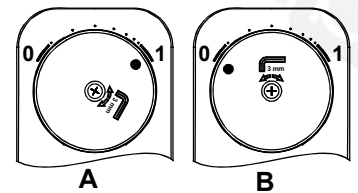

4864Z25

# SSA..

# SSB..

# SSP..

## 12

SSA31.1, SSA81.1

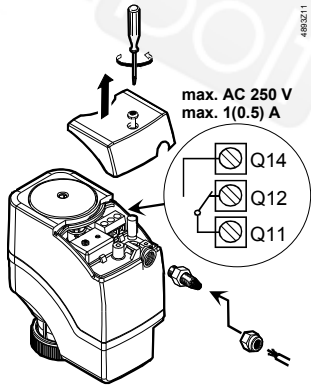

H03VV-F, 2x0.5...0.75 mm<sup>2</sup>

SSB31.1, SSB81.1

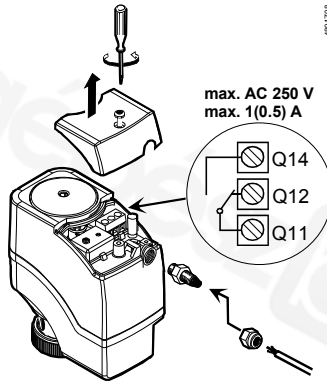

H03VV-F, 2x0.5...0.75 mm<sup>2</sup>

## 13

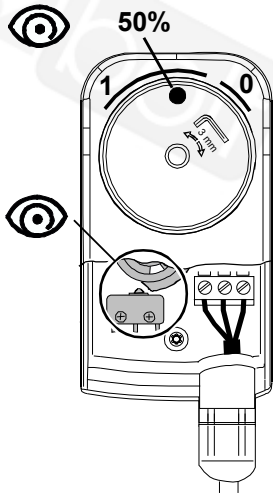
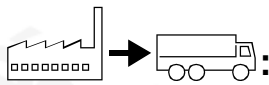

4893Z12a

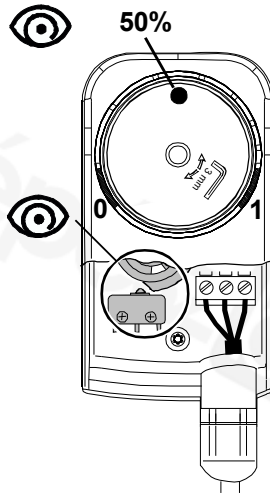
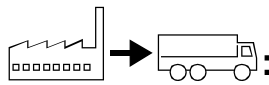

4891Z15a

## 14

0...50 %

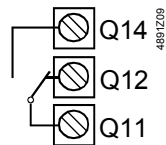

4891Z09

0...< 50 %

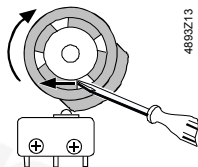

4893Z13

50...1 %

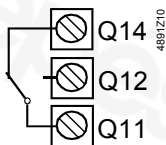

4891Z10

0...> 50 %

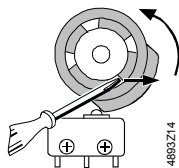

4893Z14