



Indoor Air Quality Controller **QPA84**

- With integrated VOC (Volatile Organic Compounds) sensor
- Operating voltage AC 230 V,
- Two-position output (non-potential-free relay contact)

Use

In ventilation plant to optimize the indoor air quality and the consumption of energy by providing demand-controlled ventilation.

The QAP84 indoor air quality controller has been designed for use in basic ventilation plant where there is a need to remove annoying odours from a room, depending on demand, primarily in rooms with greatly varying occupancy levels and / or odours, thereby optimizing the ventilation time and ensuring good air quality. The controller is used especially in applications where a fan or an air damper actuator is controlled either manually or by a time switch.

Typical spaces and applications:

- Small restaurants, pubs, bistros
- Lounges
- Recreation spaces and smoking areas
- Kitchens
- Changing rooms and cloakrooms
- Controlled ventilation of living spaces

Application examples

Example with extract air fan

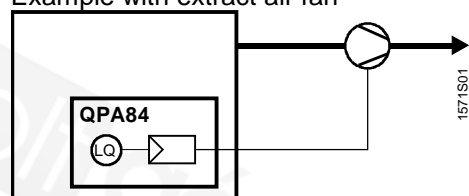

Example with extract air damper

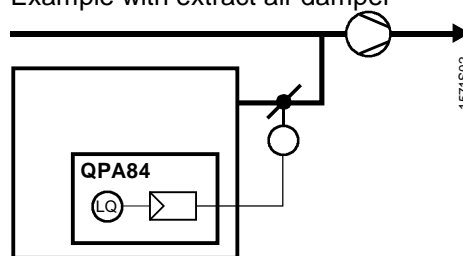

Functions

The integrated VOC sensor measures concentrations of odorous substances and gases, such as tobacco smoke, human body odours, kitchen odours, carbon monoxide, methane, ethanol, acetone, methanol, etc., in the room air.

The concentrations measured by the sensor are compared with the setpoint. If the setpoint is exceeded, the fan or the air damper actuator will be switched on via control output Y1. When the air quality improves as a result of the ventilation or other influencing factors, the device connected to control output Y1 will be deactivated again.

The QPA84 is supplied with a factory-set setpoint. As soon as the controller is connected to power, the self-adaptation algorithm ensures that the indoor air quality setpoint will be matched to the local supply air quality.

The switching on / off behaviour of control output Y1 can be changed by means of a shorting plug:

Position of shorting plug	Action
 - 0 +	Very good air quality level, increased energy consumption ¹⁾
 - 0 +	Good air quality level, optimum energy consumption¹⁾ (factory setting)
 - 0 +	Acceptable air quality level, minimum energy consumption ¹⁾

1) Energy consumption resulting from heating or cooling and fan operation.

Caution!

To change the position of the shorting plug, the housing cover must be removed. This work must be carried out by an authorized electrician since there is a risk of touching mains-carrying wires or parts.

Ordering

Product number	Stock number	Designation
QPA84	BPZ:QPA84	Indoor air quality controller

When ordering, please give name and type reference.

Equipment combinations

For indoor air quality control with extract air dampers:
OpenAir™ two-position air damper actuators **GCA32..** see data sheet N4613

Mechanical design

The controller consists of three major parts: the mounting plate made of plastic, the housing which accommodates the sensor and the control electronics, and the housing cover which is also made of plastic. Using suitable screws, the mounting plate is secured to a commercially available recessed conduit box. The housing engages in the mounting plate and is then secured by means of two catches. After wiring, the housing cover is also secured with two catches.

Sensor, connection and setting elements

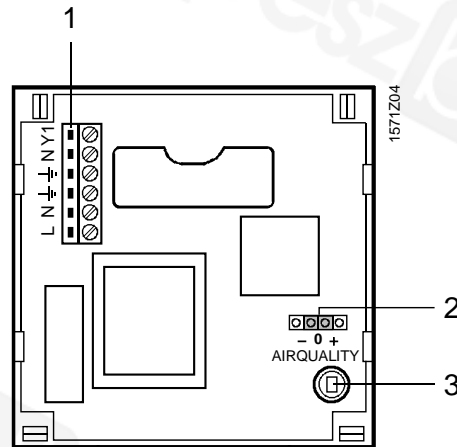

- 1 Connection terminals
- 2 Shorting plug for changing the switching on / off behaviour of control output Y1.
Plug positions:
 - = acceptable air quality
 - 0 = good air quality (factory setting)
 - + = very good air quality
- 3 VOC sensing element

Engineering notes

Power supply to the QPA84 should not be interrupted during operation (e.g. by a manual switch or time switch program). If interrupted, the controller will lose the adapted indoor air quality setpoint (the optimum setpoint for the room).

Caution!

- The QPA84 may not be used for safety-related gas measurements!
- The screw terminals are only suited for installation wires. Stranded wires are not permitted!
- A 10 A prefuse must be used in the power supply line (L) to the controller.
- The two terminals for the protective earth (interconnected inside the unit) are merely used for earthing a regulating unit of safety class I connected to output Y1

The maximum permissible switching current (I) at output Y1 must be observed. It is dependent on the ambient temperature (T) of the QPA84:

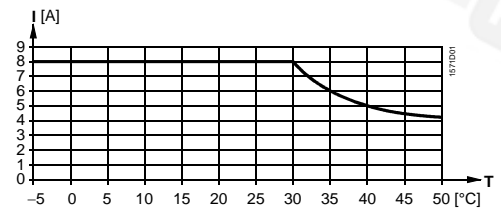

⚠ WARNING

No internal line protection for supply lines to external consumers

Risk of fire and injury due to short-circuits

- Adapt the line diameters as per local regulations to the rated value of the installed fuse.

Mounting notes

Mounting location: in the room.

The location where the controller is mounted should be representative of the indoor air quality level, e.g. on an open wall, 1.5 to 3 m above the floor.

The controller should not be mounted in niches or bookshelves, not behind curtains, etc., or in locations where people are continuously present (within one to two meters), such as speaker's desks, working places, etc.

The permissible environmental conditions must be observed.

The controller is supplied complete with detailed mounting instructions.

Caution!

The controller must be installed by an authorized electrician.

Commissioning notes

The VOC sensing element requires about one minute to attain the right operating temperature.

Control output Y1 can be activated by the electronics, depending on the mixed-gas concentration in the room.

The proper functioning of the QPA84 can then be checked as follows:

- Hold a cloth or cotton-wool pad saturated with alcohol in front of the unit's ventilation slots, or
- Let gas from a cigarette lighter enter the ventilation slots

Then, control output Y1 will be activated after a short period of time.

Operating notes

After about two days, the QPA84 will assume the setpoint that ensures optimum indoor air quality. This is accomplished by the setpoint adaptation algorithm. The algorithm adjusts the setpoint periodically. For this reason, the power supply to the controller should not be interrupted. The unit is maintenance-free.

Disposal



The devices are considered electronics devices for disposal in terms of European Directive 2012/19/EU and may not be disposed of as domestic waste.

- Dispose of the device via the channels provided for this purpose.
- Comply with all local and currently applicable laws and regulations.

Technical data

Power supply	Operating voltage Mains frequency Power consumption External supply line protection	AC 230 V + 10 % – 15 % 50 / 60 Hz ± 4 % 0.5 VA Fuse slow max. 10 A or Circuit breaker max. 13 A Characteristic B, C, D according to EN 60898
Control output Y1	Breaking voltage Switching current ¹⁾ External supply line protection	non-potential-free switching contact AC 230 V max. 8 A (res.) max. 6.8 A (ind.), $\cos\phi = 0.6$ Refer to section "Power Supply"
Terminals	Connection terminals Cable lengths L, N, PE, Y1	screw terminals for wires of 1 to 2.5 mm ² depending on the load and in compliance with local regulations
Degree of protection	Protection class Protection degree of housing	III according to EN 60730-1 IP30 according to EN 60529
Environmental conditions	Operation Climatic conditions Temperature Humidity Mechanical conditions Transport Climatic conditions Temperature Humidity Mechanical conditions Product standard	to IEC 60721-3-3 class 3K5 –5 ... +50 °C (non-condensing) <85 % r.h. class 3M2 to IEC 60721-3-2 class 2K3 –25 ... +65 °C <95 % r.h. class 2M2 EN 60730-1 Automatic electrical controls for household and similar use
	Electromagnetic compatibility (Applications)	For use in residential, commerce, light-industrial and industrial environments
	EU Conformity (CE)	CM2T1571xx ²⁾
Dimensions	Refer to "Dimensions"	
Weight	Incl. packing	0.28 kg

- 1) The maximum permissible switching current is dependent on the ambient temperature of the QPA84 (refer to "Engineering notes")
- 2) The documents can be downloaded from <http://siemens.com/bt/download>

Internal diagrams

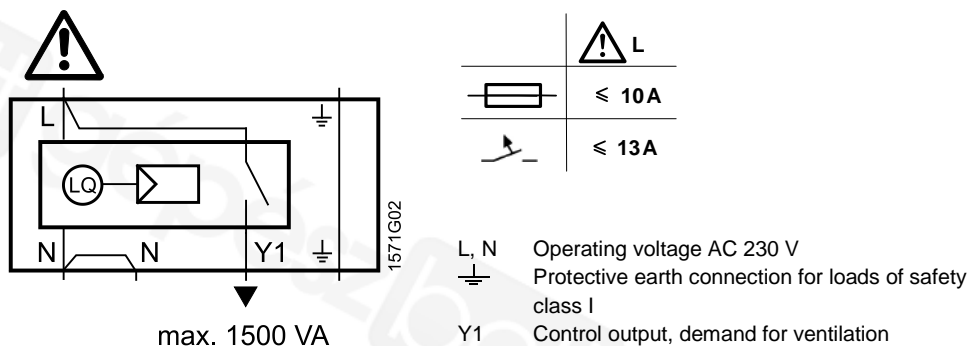

Dimensions

Dimensions in mm

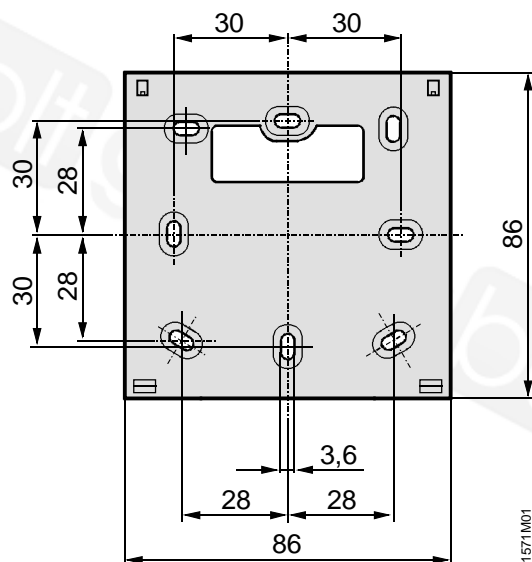
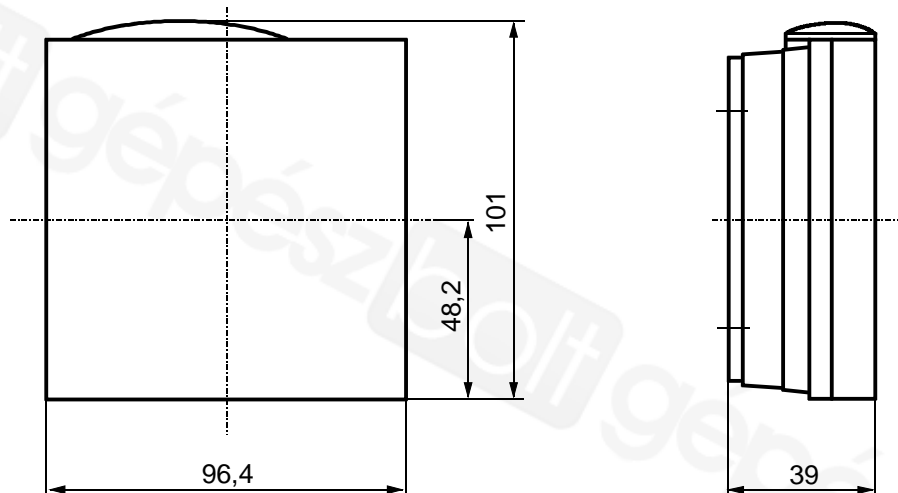

Mounting plate

1571M01