

SIEMENS



**RDG20..KN.. & RDG26..KN..,
RDG200T, RDG260T**

**Room thermostats,
communicating and standalone**

Basic Documentation

Table of Contents

1	About this document	5
1.1	Revision history	5
1.2	Reference documents	6
1.3	Before you start	7
1.3.1	Trademarks	7
1.3.2	Copyright	7
1.3.3	Quality assurance	8
1.3.4	Document user/request to the reader	8
1.4	Target audience, prerequisites	8
1.5	Glossary	9
2	Overview	10
2.1	Types	10
2.2	Functions	11
2.3	Accessories	15
2.4	Equipment combinations	15
2.4.1	Recommended RDG actuators and 6-port valves combinations	19
2.5	Integration via KNX bus	20
3	Notes	23
3.1	Mounting and installation	23
3.2	Commissioning	24
3.3	Operation	26
3.4	Remote operation	29
3.5	Disposal	29
3.6	Cyber security disclaimer	29
4	Functions	30
4.1	Temperature control	30
4.2	Operating modes	31
4.2.1	Different ways to influence operating mode	32
4.2.2	Communication examples	38
4.3	Room temperature setpoints	40
4.3.1	Description	40
4.3.2	Setting and adjusting setpoints	42
4.4	Application overview	45
4.4.1	Applications for fan coil systems	46
4.4.2	Applications for universal systems	47
4.4.3	Application for heat pump systems	48
4.4.4	Application with additional ventilation function	49
4.5	Power supply selection for RDG20..KN	52
4.6	Additional functions	53
4.6.1	Sensors and changeover functions	54
4.6.2	Presence detector	56
4.6.3	Output functions	57
4.6.4	Monitoring and limiting functions	59

4.6.5	User operation / Indication	63
4.6.6	Humidity (RDG2..KN)	65
4.6.7	Scheduler.....	69
4.6.8	M/S, manager/subordinate (RDG2..KN)	71
4.6.9	Preventive operation	74
4.6.10	NFC communication	75
4.6.11	CO ₂ (IAQ) monitoring and control (RDG2..4KN)	75
4.6.12	Power reserve clock (RDG2..T).....	85
4.6.13	Control strategy (P450).....	86
4.7	Control sequences	87
4.7.1	Sequence overview (setting via P001)	87
4.7.2	Application mode	88
4.7.3	2-pipe fan coil unit.....	90
4.7.4	2-pipe fan coil unit with electric heater	91
4.7.5	2-pipe fan coil unit with radiator or floor heating.....	93
4.7.6	2-stage on 2-pipe/4-pipe heating and cooling	95
4.7.7	4-pipe fan coil unit.....	100
4.7.8	4-pipe fan coil unit with electric heater	105
4.7.9	Chilled/heated ceiling and radiator applications	107
4.7.10	Compressor applications	108
4.7.11	Additional ventilation functions (IAQ + cooling with air).....	109
4.7.12	Applications with external AQR sensor or QMX room operator unit (RDG2..KN).....	121
4.7.13	Setpoints and sequences	122
4.8	Control outputs	124
4.8.1	Overview	124
4.8.2	Control output configuration for 6-port valve (P201)	128
4.8.3	Control output configuration (setting via DIP switches 7/8 or tool, and P201/P203/P204/P205).....	129
4.9	Fan control	131
4.10	Multifunctional input, digital input	138
4.11	Handling system faults	141
4.12	KNX communications (RDG2..KN)	141
4.12.1	S-Mode	141
4.12.2	M/S, Manager/subordinate configuration in KNX S-Mode.....	142
4.12.3	LTE-Mode	145
4.12.4	Zone addressing in LTE-Mode (with Synco)	145
4.12.5	M/S, Manager/subordinate configuration in LTE-Mode.....	147
4.12.6	Example of heating and cooling demand zones.....	149
4.12.7	Send heartbeat and receive timeout.....	150
4.12.8	Startup	150
4.12.9	Heating and cooling demand.....	150
4.12.10	Fault and alarms function on KNX.....	151
4.12.11	PL-Link integration in PXC 4, 5 and 7	153
4.13	Communication objects (RDG2..KN)	154
4.13.1	Overview	154
4.13.2	Description of communication objects	156
4.14	Communication objects (LTE-Mode) (RDG2..KN)	162

4.15	Control parameters.....	163
4.15.1	Parameter setting via local HMI.....	163
4.15.2	Setting/downloading parameter via tool (RDG2..KN).....	164
4.15.3	Service level parameters.....	165
4.15.4	Expert level parameters with diagnostics and test.....	167
5	Supported tools.....	173
5.1	ETS.....	173
5.1.1	Setting parameters in ETS.....	174
5.2	ACS tool.....	176
5.2.1	Setting parameters in ACS.....	176
5.2.2	Operation and monitoring with ACS.....	177
5.2.3	Operation and monitoring with OZW772.....	182
5.3	PCT Go – Smartphone app.....	183
5.3.1	Commissioning parameter via PCT Go.....	184
5.3.2	Read live data via PCT Go.....	185
5.4	ABT Site / ABT Go (PXC, PL-link integration).....	186
5.4.1	Operation with ABT Site.....	186
6	Connection.....	187
6.1	Connection terminals.....	187
6.2	Connection diagrams.....	189
6.3	IAQ - CO2 connection diagrams (RDG2..KN).....	193
6.4	Application examples.....	193
6.4.1	Humidity control.....	193
6.4.2	Relay functions.....	196
6.4.3	Swap function and/or fan in the 2nd stage.....	198
6.4.4	IAQ -CO ₂ control (RDG2..KN).....	201
6.4.5	Ventilation air cooling (RDG2..KN).....	203
7	Technical data.....	207
8	Dimensions.....	213
	Index.....	214

1 About this document

1.1 Revision history

Edition	Date	Changes	Section	Product no. (product index)
1	September 2020	First version.	All	RDG200KN (A) RDG260KN (A)
2	November 2020	<ul style="list-style-type: none"> Update NFC communication info Update changeover picture Update the picture of DC 0...10 V fan in "Fan control with modulating heating/cooling control" Update info about geographical zones P901 and P902 Update ACS version info 	<ul style="list-style-type: none"> 4.6.8 4.7.9.2 4.9 4.12.3 1.5, 5.2 	
3	January 2021	<ul style="list-style-type: none"> Add 4-pipe/2-stage related info Add scheduler-info Add information on return flow temperature control Add information on manager/subordinate function Add EU-bac information Add information that terminal U1 is also defined as output Add new parameters 	<ul style="list-style-type: none"> 2.2, 3.2, 4.6, 4.6.4, 4.7.1, 4.7.6.2, 4.7.9, 4.7.12, 4.8.2, 5.2.2, 6.2 3.3, 4.2, 4.4, 4.6, 4.6.5 4.6, 4.6.4 4.2.1, 4.6, 4.6.7 7 6.1 4.15.4, 4.15.5 	RDG200KN (B) RDG260KN (B) RDG200KN/BK (A) RDG260KN/BK (A)
4	April 2022	<ul style="list-style-type: none"> Add new variants RDG204KN and RDG264KN Add IAQ info Add on/off damper control info Update M/S to manager/subordinate Add black version variants info 	<ul style="list-style-type: none"> 2.1, 2.2, 4.15.4, 4.15.5 3, 4.11 4.6.3 All 2.1, 2.2, 7 	RDG204KN (A) RDG264KN (A)
		<ul style="list-style-type: none"> Hotel: Switch the unit between °C and °F via operating mode button 	<ul style="list-style-type: none"> 4.1 	RDG200KN (C) RDG260KN (C) RDG200KN/BK (C) RDG260KN/BK (C)
5	February 2023	<ul style="list-style-type: none"> Add new application 4-pipe with 6-port PICV Add fan output for application 4-pipe with 6-port ball valve as changeover and PICV Add new variants RDG200T and RDG260T 	<ul style="list-style-type: none"> 2.4.1, 4.7.7.1, 4.7.7.2, 4.8.2 4.7.9 All 	RDG200KN (D) RDG260KN (D) RDG200KN/BK (D) RDG260KN/BK (D) RDG200T (A) RDG260T (A)

Edition	Date	Changes	Section	Product no. (product index)
6	June 2023	<ul style="list-style-type: none"> • Add forced ventilation info • Add information on maximal limitation for IAQ damper position • Add information on PCT Go and product index • Support applications with 6-port ball and 6-port PICV • Fan override in all applications (selectable) • Humidity control in Economy mode (enable/disable) • Maximal position of valves (on DC actuators) can be set independently in heating and cooling mode • Fault alarm for external temperature sensor on the bus • Features: Heartbeat – Automatic detection 	<ul style="list-style-type: none"> • 4.6.11, 4.15.3, 4.15.4 • 4.6.11, 4.15.4 • 5, 5.3 	RDG204KN (B) RDG264KN (B)
7	January 2024	<ul style="list-style-type: none"> • PL-Link integration into PXC4, 5, and 7 • P450 extension • Air cooling/ventilation • VAV, cooling only • Setting setpoint and min./max. position via S-Mode objects • Add RDG2..4KN black version variants info 	<ul style="list-style-type: none"> • 1.2, 1.4, 1.5, 2.2, 2.5, 3.2, 4.4, 4.6.8, 4.9, 4.12, 4.12.11, 4.14, 4.15.4, 4.15.6, 5, 5.4 • 4.6.13 • 4.4.4, 4.6, 4.6.11, 4.7.11, 6.4.5 • 4.4.4.3, 4.7.11.5 • 4.6.4, 4.6.11.2, 4.6.11.3, 4.7.11, 4.13.1, 4.13.2 • 2.1 	RDG200KN (E) RDG260KN (E) RDG204KN (C) RDG264KN (C) RDG204KN/BK (C) RDG264KN/BK (C)

1.2 Reference documents

Subject	Ref.	Document title	Document number
Room thermostats with KNX communications, RDG2..KN	[1]	Mounting instructions (RDG20..KN)	A6V11546008
	[2]	Mounting instructions (RDG26..KN)	A6V11844861
	[3]	Operating Instruction	A6V11545973
	[4]	Data sheet	A6V11545853
Room thermostats RDG2..T	[5]	Mounting instructions (RDG20..T)	A6V13375634
	[6]	Mounting instructions (RDG26..T)	A6V13375640
	[7]	Operating Instruction	A6V13496247
	[8]	Data sheet	A6V13375643
KNX manual	[9]	Handbook for Home and Building Control – Basic Principles (EN: https://my.knx.org/shop/product?language=en&product_type_category=books&product_type=handbook DE: https://my.knx.org/shop/product?language=de&product_type_category=books&product_type=handbook)	
Synco and KNX (see	[10]	KNX bus, data sheet	CE1N3127

Subject	Ref.	Document title	Document number
www.siemens.com/synco)	[11]	Communication via the KNX bus for Synco 700, 900 and RXB/RXL, Basic documentation	CE1P3127
	[12]	Planning and commissioning protocol, communication Synco 700	XLS template in HIT
	[13]	RMB795B central control unit, data sheet	CE1N3122
	[14]	RMB795B central control unit, Basic documentation	CE1P3122
	[15]	KNX S-Mode data points	CE1Y3110
	[16]	Product data for ETS	
	[17]	ETS product data compatibility list	CE1J3110
	[18]	Synco Application manual	0-92168en
Desigo engineering documents	[19]	Desigo RXB integration – S-Mode	CM1Y9775
	[20]	Desigo RXB/RXL integration – Individual addressing	CM1Y9776
	[21]	Third-party integration	CM1Y9777
	[22]	Synco integration	CM1Y9778
	[23]	Working with ETS	CM1Y9779
Web server OZW772	[24]	Commissioning instructions	CE1C5701
Desigo PL-Link integration	[25]	Desigo™ PXC4, PXC5 & PXC7 Automation controls for high-tech buildings Range Description	A6V13054432
	[26]	Desigo™ PXC4, PXC5 & PXC7 Planning overview	A6V13054435

1.3 Before you start

1.3.1 Trademarks

The table below lists the third-party trademarks used in this document and their legal owners. The use of trademarks is subject to international and domestic provisions of the law.

Trademarks	Legal owner
Synco™	
Android™	Google Inc.
App Store®	Apple Inc.
Google Play™	Google Inc.

All product names listed in the table are registered (®) or not registered (™) trademarks of the owner listed in the table. We forgo the labeling (e.g. using the symbols ® and ™) of trademarks for the purposes of legibility based on the reference in this section.

1.3.2 Copyright

This document may be duplicated and distributed only with the express permission of Siemens, and may be passed only to authorized persons or companies with the required technical knowledge.

1.3.3 Quality assurance

This document is prepared with great care.

- The contents of this document are checked at regular intervals.
- Any corrections necessary are included in subsequent versions.
- Documents are automatically amended as a consequence of modifications and corrections to the products described.

Please make sure that you are aware of the latest document revision date.

If you find lack of clarity while using this document, or if you have any criticisms or suggestions, please contact the Product Manager in your nearest branch office.

The addresses of the Siemens Regional Companies are available at

www.buildingtechnologies.siemens.com.

1.3.4 Document user/request to the reader

Before using products from Siemens Industry, Inc., it is important that you read the documents supplied with or ordered at the same time as the products (equipment, applications, tools, and so on) carefully and in full.

We assume that persons using our products and documents are authorized and trained appropriately and have the technical knowledge required to use our products as intended.

More information on the products and applications is available:

- On the intranet (Siemens employees only) at <https://wse04.siemens.com/content/P0002723/SitePages/Home.aspx>
- From the Siemens branch office near you www.buildingtechnologies.siemens.com or from your system supplier
- From the support team at headquarters fieldsupport-zug.ch.sbt@siemens.com if there is no local point of contact

Siemens assumes no liability to the extent allowed under the law for any losses resulting from a failure to comply with the aforementioned points or for the improper compliance of the same.

1.4 Target audience, prerequisites

This document assumes that users of the RDG2..KN room thermostats are familiar with the ETS tool, Synco ACS tool, Desigo ABT Site tool or all and can use them.





It is also assumed that these users are aware of the specific conditions associated with KNX.

In most countries, specific KNX know-how is conveyed through training centers certified by the KNX Association (see www.knx.org/).

For reference documentation, see Reference documents [→ 6].

1.5 Glossary

The inputs, outputs and parameters of an application can be influenced in various ways. These are identified by the following symbols in this document:

	Parameters identified by this symbol are set using ETS.
	Parameters identified by this symbol are set using ACS.
 Note!	Setting RDG2..KN KNX parameters is only supported by the following tool versions: <ul style="list-style-type: none"> • ETS5 or higher versions • ACS version 13.03 or higher • ABT Site V5.2 / ABT Go V5.2
	Inputs and outputs identified by this symbol communicate with other KNX devices. They are called communication objects (CO). The communication objects of the RDG2..KN works partly in S-Mode, partly in LTE-Mode, and partly in both. These objects are described accordingly. A list of the parameters is shown in Control parameters [→ 163].

2 Overview

2.1 Types

For fan coil units, universal applications and compressors in DX-type equipment applications

KNX communication products

Product no.	Stock no.	Housing color	Operating voltage	Fan		Number of control outputs					Built-in sensor T: Temperature H: Humidity CO ₂
				3-speed	DC	On/Off	PWM	3-pos	DC	On/Off (3-wire)	
RDG200KN	S55770-T409	White	AC 24 V or AC 230 V	✓	✓ ¹⁾	4	4	2	–	2	T, H
RDG200KN/BK	S55770-T452	Black	AC 24 V or AC 230 V	✓	✓ ¹⁾	4	4	2	–	2	T, H
RDG204KN	S55770-T410	White	AC 24 V or AC 230 V	✓	✓ ¹⁾	4	4	2	1	2	T, H, CO ₂
RDG204KN/BK	S55770-T454	Black	AC 24 V or AC 230 V	✓	✓ ¹⁾	4	4	2	1	2	T, H, CO ₂
RDG260KN	S55770-T412	White	AC 24 V or DC 24 V	✓	✓ ¹⁾	–	–	–	4	–	T, H
				–	✓ ¹⁾	2 ²⁾	–	–	–	–	
RDG260KN/BK	S55770-T453	Black	AC 24 V or DC 24 V	✓	✓ ¹⁾	–	–	–	4	–	T, H
				–	✓ ¹⁾	2 ²⁾	–	–	–	–	
RDG264KN	S55770-T413	White	AC 24 V or DC 24 V	✓	✓ ¹⁾	–	–	–	4	–	T, H, CO ₂
				–	✓ ¹⁾	2 ²⁾	–	–	–	–	
RDG264KN/BK	S55770-T455	Black	AC 24 V or DC 24 V	✓	✓ ¹⁾	–	–	–	4	–	T, H, CO ₂
				–	✓ ¹⁾	2 ²⁾	–	–	–	–	

Standalone products

Product no.	Stock no.	Housing color	Operating voltage	Fan		Number of control outputs					Built-in sensor T: Temperature H: Humidity CO ₂
				3-speed	DC	On/Off	PWM	3-pos	DC	On/Off (3-wire)	
RDG200T	S55770-T457	White	AC 230 V	✓	✓ ¹⁾	3	3	2	–	2	T
RDG260T	S55770-T458	White	AC 24 V or DC 24 V	✓	✓ ¹⁾	–	–	–	3	–	T
				–	✓ ¹⁾	2 ²⁾	–	–	–	–	

¹⁾ The terminal Y50 is used as DC 0...10 V output.

²⁾ The output is relay On/Off.

2.2 Functions

Control application

The RDG2.. room thermostats are designed for use with the following:

Fan coil units via On/Off or modulating/DC control outputs:

- 2-pipe system
- 2-pipe system with electric heater
- 2-pipe system with radiator/floor heating
- 2-pipe/2-stage system also suitable for applications with 1-stage heating/ 2-stage cooling, or 2-stage heating/1-stage cooling
- 4-pipe system
- 4-pipe system with electric heater
- 4-pipe system with a 6-port ball valve (RDG26..)
- 4-pipe system with 6-port PICV (RDG26..)
- 4-pipe system with PICV and 6-port ball valve as changeover (RDG26..)
- 4-pipe/2-stage system also suitable for applications with 1-stage heating/ 2-stage cooling, or 2-stage heating/1-stage cooling (RDG2..KN)

Chilled/heated ceilings (or radiators) via On/Off or modulating/DC control outputs:

- Chilled/heated ceiling
- Chilled/heated ceiling with electric heater
- Chilled/heated ceiling and radiator/floor heating
- Chilled ceiling and radiator/floor heating
- Chilled and/or heated ceiling/2-stage
- Chilled/heated ceiling (4-pipe) with 6-port ball valve (RDG26..)
- Chilled/heated ceiling (4-pipe) with 6-port PICV (RDG26..)
- Chilled/heated ceiling with PICV and 6-port ball valve as changeover (RDG26..)

Compressor applications via On/Off control:

- Heating or cooling, compressor in DX-type equipment
- Heating or cooling, compressor in DX-type equipment with electric heater
- Heating and cooling, compressor in DX-type equipment
- Heating or cooling/2-stage, compressor in DX-type equipment

Ventilation applications:

- Single duct cooling only
- Single duct cooling only and electric heater
- Single duct cooling only and radiator/floor heating

General functions

- Weekly scheduler
- M/S - manager/subordinate function between thermostats (RDG2..KN)
- Room temperature control via built-in temperature sensor or external room temperature/return air temperature sensor
- Room relative humidity control via built-in humidity sensor or external room humidity sensor (humidity function can be disabled.) (RDG2..KN)
- Min./max. humidity control by shifting temperature setpoint and releasing contact for dehumidifier/humidifier (RDG2..KN)
- Floor heating temperature limitation
- Min. and max. supply air temperature limitation

- Selection of operating modes via operating mode button
- Button lock for all buttons independently (automatically or manually)
- Changeover between heating and cooling mode (automatic via local sensor or bus, or manually)
- Parameters protected by password (disabled by default)
- Purge function together with 2-port valve
- Valve kick/exercising function to prevent gripping
- Reminder to clean fan filters
- Indoor air quality monitoring and controlling (CO₂) via fresh air damper (RDG204KN & RDG264KN)
- Start forced ventilation via fan button to introduce fresh air in the room (RDG2..4KN)
- Black color versions (RDG200KN/BK & RDG260KN/BK)
- Delta temperature control
Limiting temperature difference between flow and return temperature for water to optimize the system and reduce energy consumption in district heating systems
- Power reserve clock for 20 h during power failure (RDG2..T)

Setpoints and display

- Min. and max. limitation of room temperature setpoint:
 - Comfort limitation (min. and max. limitation)
 - Energy saving concept (min. and max. limitation separate for heating and cooling)
- Temporary Comfort mode extension
- Green leaf indication function (RDG2..KN)
- Display of current room temperature or setpoint in °C, °F or both
- Absolute and relative setpoint indication (RDG2..KN)
- Display of CO₂ value in ppm (parts per million) or text (GOOD; FAIR; BAD: RDG204KN & RDG264KN)

Setting

- Application selection via DIP switches or external commissioning software (RDG2..KN: ACS, ETS, ABT Site and Siemens smartphone app PCT Go; RDG2..T: Siemens smartphone app PCT Go)
- Parameter download with external commissioning software (RDG2..KN: ACS, ETS, ABT Site and Siemens smartphone app PCT Go; RDG2..T: Siemens smartphone app PCT Go)
- Reloading factory settings for commissioning and control parameters

Fan

- 1-speed, 3-speed or DC 0...10 V fan control on RDG20.. and RDG26.. (automatic or manual fan)
- Advanced fan control function, e.g. fan kick, fan start delay, selectable fan operation (enable, disable, depending on heating/cooling mode, or min. and max. speed setting)
- Fan start depending on fan coil temperature (heating) to avoid cool air while heating
- Enabling fan output only in the 2nd stage (2-pipe/2-stage, 4-pipe/2-stage (RDG2..KN))
- Enabling fan output only in the 2nd stage (2-pipe/2-stage (RDG2..T))
- Switching fan speed from manual to automatic in the dead zone to avoid energy waste (selectable function)

Special functions

- Cooling with air combined with IAQ control, for fan coil, universal and VAV systems (RDG2..4KN)
- Swap function for 2-pipe and 2-stage application by switching the 1st stage heating to 2nd stage cooling
- In 2-stage applications, limit the number of heating or cooling sequence to one
- Control of 6-port ball valve and for 6-port PICV, DC 0...10 V, DC 0...10 V (3rd part), DC 2...10 V and inverted signals DC 10...0 V, DC 10...2 V, DC 10...2 V (3rd part) (RDG26..)
- Control of 6-port ball valve as changeover (On/Off – open/close signal) and PICV DC 0...10 V
- Control of 6-port ball valve via KNX S-Mode objects (RDG20..KN and RDG26..KN)
- Flow limitation function for PICV in heating and cooling mode (RDG26..)
- Set holiday period to reduce energy consumption during absences (holidays)
- For 6-port PICV (RDG26..)
 - During commissioning, maximal water flow selection in l/h for heating (P260) and for cooling (P261) independently via PCT Go
 - During operation, read water flow (l/h) via PCT Go live data function
- Selectable relay functions
 - Switch off external equipment during Protection mode
 - Switch on external equipment (e.g., pump) during heating/cooling demand
 - Output status heating/cooling sequence
 - Dehumidification/humidification control output (RDG2..KN)

Inputs/outputs (RDG2..KN)

- 2 multifunctional inputs X1, X2, and 1 multifunctional input/output U1 set as input, selectable for:
 - Window contact switches operating mode to Protection
 - Presence detector switches operating mode to Comfort
 - Sensor for automatic heating/cooling changeover
 - Switch for manual heating/cooling changeover
 - External room temperature or return air temperature sensor
 - Dewpoint sensor
 - Enable electric heater
 - Fault input
 - Monitor input for temperature sensor or switch status
 - Supply air temperature sensor
 - Coil temperature sensor
 - External temperature limit
 - Hotel presence detector
- 1 multifunctional input/output U1 set automatically as output for:
 - 4-pipe/2-stage as 2nd stage cooling output (RDG26..KN)
 - IAQ control (damper and fan) (RDG204KN & RDG264KN)

Inputs (RDG2..T)

- 3 multifunctional inputs X1, X2 and X3, selectable for:
 - Window contact switches operating mode to Protection
 - Presence detector switches operating mode to Comfort
 - Sensor for automatic heating/cooling changeover
 - Switch for manual heating/cooling changeover
 - External room temperature or return air temperature sensor
 - Dewpoint sensor
 - Enable electric heater

- Fault input
- Supply air temperature sensor
- Coil temperature sensor
- External temperature limit
- Hotel presence detector

KNX communication features (RDG2..KN)

- KNX bus (terminals CE+ and CE-) for communication with Synco devices or KNX compatible devices
- M/S - manager/subordinate function via LTE-Mode or S-Mode to synchronize equipment and save energy in open spaces
- M/S - manager/subordinate alarm management via LTE-Mode allowing for subordinate alarm display on the manager
- Display of outside temperature, humidity, CO₂ or time of day from KNX bus
- Time scheduling and central control of setpoints from KNX bus
- Control of Economy setpoints via KNX bus
- Relative humidity setpoint via KNX bus
- Control of KNX actuators and fan via S-Mode objects
- Adjustment for setpoint (temperature, humidity, CO₂), min./max. position (damper, PICV, fan speed), via S-Mode objects
- Energy supply optimization via energy demand signal via Synco RMB795B central control unit or PXC4/5/7
- Interworking with Siemens AQR.. and QMX.. sensors for room humidity, room temperature and CO₂ measurement
- Interworking with Siemens QMX.. room operator units for room humidity, room temperature and operating commands for fan, operating mode and setpoints
- Interworking with PXC4/5/7 in KNX PL-Link
- Commissioning KNX area, line and device address via mobile application PCT Go

Overview difference between KNX (RDG2..KN) and standalone (RDG2..T) versions









Functions	Descriptions	KNX	Standalone
KNX communication related functions	<ul style="list-style-type: none"> • Communicating thermostat [→ 141] • Commissioning via ETS, ACS [→ 24] 	✓	
	<ul style="list-style-type: none"> • Manager/Subordinate [→ 71] 	✓	
Power switch (RDG2..KN)	<ul style="list-style-type: none"> • Power switch AC 230 V / AC 24 V [→ 52] 	✓	
	<ul style="list-style-type: none"> • Support AC 24 V 2-pos/3-pos actuators [→ 15] 	✓	
Functional input/output	<ul style="list-style-type: none"> • Functional input/output U1 [→ 138] 	✓	
	<ul style="list-style-type: none"> • Multifunctional input X3 (sensor, switch) [→ 138] 		✓
	<ul style="list-style-type: none"> • Monitor input for temperature sensor or switch status [→ 138] 	✓	
Application	<ul style="list-style-type: none"> • 4-pipe/2-stage [→ 98] 	✓	
Time clock	<ul style="list-style-type: none"> • Power reserve clock for 20 h during power failure [→ 85] 		✓
Others	<ul style="list-style-type: none"> • Humidity [→ 65] • Indoor air quality control [→ 75] • Greenleaf indication [→ 63] 	✓	

2.3 Accessories

Product series	Type	Product/stock no.	Datasheet
RDG2..KN	KNX power supply 160 mA (Siemens BT LV)	5WG1 125-1AB02	TPI_N125
	KNX power supply 320 mA (Siemens BT LV)	5WG1 125-1AB12	TPI_N125
	KNX power supply 640 mA (Siemens BT LV)	5WG1 125-1AB22	TPI_N125
RDG2..KN RDG2..T	Mounting adapter for RDG2..KN and RDG2..T	ARG200: S55770-T438 ¹⁾	-

¹⁾ ARG200 mounting adapter is used to wall-mount the RDG2..KN and RDG2..T where a conduit box is not available. For easier wiring, removable knockouts on all sides are available. For dimensions, see Dimensions [→ 213].

2.4 Equipment combinations

Type of unit		Product no.	Datasheet ¹⁾
Cable temperature or changeover sensor, cable length 2.5 m NTC (3 kΩ at 25 °C)		QAH11.1	1840
Cable temperature sensor PVC 2 m, LG-Ni1000		QAP22	1831
Room temperature sensor NTC (3 kΩ at 25 °C)		QAA32	1747
Room temperature sensor LG-Ni1000		QAA24	1721
Front modules with passive temperature measurement LG-Ni1000		AQR2531ANW	1408
Strap-on temperature sensor LG-Ni1000		QAD22	1801
Condensation monitor		QXA21..	A6V10741072
Flush-mount KNX room sensor (base and front module)		AQR2570N.. AQR2532NNW AQR2533NNW AQR2535NNW	1411
Wall-mounted KNX sensors		QMX3.P30 QMX3.P70	1602

On/Off and PWM actuators ¹⁾

Type of unit		Product no.	Datasheet ^{*)}
Thermal actuator (for radiator valves) AC 230 V, NC		STA321.. ¹⁾	A6V14028280
Thermal actuator (for radiator valves) AC 24 V, NC		STA121.. ¹⁾	A6V14028280
Thermal actuator AC 230 V (for small valves 2.5 mm), NO		STP321.. ¹⁾	A6V14028280
Thermal actuator AC 24 V (for small valves 2.5 mm), NO		STP121.. ¹⁾	A6V14028280





3-position actuators AC 230 V

Type of unit		Product no.	Datasheet ^{*)}
Electric actuator, 3-position (for radiator valves) AC 230 V		SSA331..	A6V11858276
Electric actuator, 3-position (for 2- and 3-port valves/V..P45) AC 230 V		SSC31	4895
Electric actuator, 3-position (for small valves 2.5 mm) AC 230 V		SSP31..	4864
Electric actuator, 3-position (for small valves 5.5 mm) AC 230 V		SSB31..	4891
Electric actuator, 3-position (for small valve 5 mm) AC 230 V		SSD31..	4861
Electric actuator, 3-position (for valves 5.5 mm) AC 230 V		SAS31..	4581
Rotary actuators for ball valves, 3-position		GDB331.9E	4657
Rotary actuators for ball valves, 2 or 3-position		GDB141.9E GDB341.9E	A6V10636150









3-position actuators AC 24 V

Type of unit		Product no.	Datasheet ^{*)}
Electric actuator, 3-position (for radiator valves) AC 24 V		SSA131..	A6V11858276
Electric actuator, 3-position (for 2- and 3-port valves/V..P45) AC 24 V		SSC81	4895
Electric actuator, 3-position (for small valves 2.5 mm) AC 24 V		SSP81..	4864
Electric actuator, 3-position (for small valves 5.5 mm) AC 24 V		SSB81..	4891
Electric actuator, 3-position (for small valve 5 mm) AC 24 V		SSD81..	4861

On/Off actuators

Type of unit		Product no.	Datasheet ¹⁾
Electromotive On/Off actuator		SFA21.. SFA71..	4863
Electromotive On/Off valve and actuator (only available in AP, UAE, SA and IN)		MVI../MXI..	A6V11251892
Electromotive actuator		SUA21/3	A6V10446174
Electromotive actuator for zone valve		SUE21	A6V11866674
Electromotive actuator for PICV		SUE21P	A6V11780777

DC 0...10 V actuators







Type of unit		Product no.	Datasheet ¹⁾
Electric actuator, DC 0... 10 V (for radiator valves)		SSA161..	A6V1185827 8
Electric actuator, DC 0... 10 V (for 2- and 3-port valves/V..P45)		SSC161..	A6V1268151 1
Electric actuator, DC 0... 10 V (for small valves 2.5 mm)		SSF161..	A6V1268151 1
Electric actuator, DC 0... 10 V (for small valves 5.5 mm)		SSB161..	A6V1268151 1
Electromotive actuator, DC 0... 10 V (for valves 5.5 mm)		SAS61..	4581
Electrothermal actuator, AC 24 V, NC, DC 0...10 V, 1 m		STA161..	A6V14028280
Electrothermal actuator, AC 24 V, NO, DC 0...10 V, 1 m		STP161..	A6V14028280
Rotary actuators for ball valves AC 24 , DC 0... 10 V		GDB161.9E	4657

DC 0...10 V actuators 6-port / PICV (RDG26..)



Type of unit		Product no.	Datasheet ¹⁾
Rotary actuators for 6-port ball valves control: <ul style="list-style-type: none"> • 6-port ball valve VWG41..., VWG42.. • 6-port PICV VWPG51.. For details, see Recommended RDG actuators and 6-port valves combinations [→ 19].		GDB161.9../6W	A6V12986395

Note: Set the control signal accordingly if RDG26.. is required to control GDB161.9E, see Control output configuration for 6-port valve (P201) [→ 128].



DC 0...10 V damper actuators

Type of unit		Product no.	Datasheet ^{*)}
Air damper actuators DC 0...10 V, AC/DC 24 V		GQD166.1A GQD161.1A	4604
Air damper actuators DC 0...10 V, AC 24 V		GDB16..1 GLB16..1	4634
Air damper actuators DC 0...10 V, AC/DC 24 V		GMA16..1	4614
Air damper actuators DC 0...10 V, AC 24 V		GEB16..1	4621
Air damper actuators DC 0...10 V, AC/DC 24 V		GCA16..1	4613
Air damper actuators DC 0...10 V, AC 24 V		GGB16..1 GIB16..1	4626
VAV compact controller		GDB181.1.. GLB181.1..	A6V10631834



On/Off damper actuators
AC 230 V

Type of unit		Product no.	Datasheet ^{*)}
Air damper actuators 2-position, AC 230 V		GQD32..1	4604
		GMA32..1	4614
		GCA32..1	4613

On/Off damper actuators
AC 24 V

Type of unit		Product no.	Datasheet ^{*)}
Air damper actuators 2-position, AC/DC 24 V		GQD12..1	4604
		GMA12..1	4614
		GCA12..1	4613

**KNX actuators
(RDG2..KN)**

Type of unit		Product no.	Datasheet ^{*)}
Rotary actuators for ball valves KNX S-Mode		GDB111.9E/KN	A6V10725318
VAV compact controller KNX / PL-Link		GDB181.1E/KN	3547

^{*)} The documents can be downloaded from <https://hit.sbt.siemens.com>

¹⁾ The PWM control on 2 or more thermal actuators in parallel can be used for floor heating/radiator applications. If several fan coil units are controlled by the same room thermostat, motorized actuators with On/Off or 3-position control are preferred.

Note:

For more information about parallel operation and the max. number of actuators that can be used, refer to the data sheets of the selected actuator type and the following list:

Max. number of actuators in parallel on RDG20.. (AC 230 V):

- 6 SS..31.. actuators (3-position)
- 1 ST..321.. if used with On/Off control signal
- 10 SFA.., SUA.., MVI.., MXI.. On/Off actuators
- Parallel operation of SAS31 not available

Max. number of actuators in parallel on RDG20..KN (AC 24 V):

- 6 SS..31.. actuators (3-position)
- 3 ST..121.. if used with On/Off control signal
- 2 SFA71.. On/Off actuators
- Parallel operation of SAS81 not available

Max. number of actuators in parallel on RDG26.. (AC 24 V):

- 10 SS..61.. actuators (DC)
- 10 ST..121../161../321.. actuators (DC or On/Off)
- 10 SFA.., SUA.., MVI.., MXI.. On/Off actuators
- 10 SAS61.. actuators (DC)
- 10 GDB161.9../6W

2.4.1 Recommended RDG actuators and 6-port valves combinations

Use the following RDG260.. versions (see below) to ensure optimal temperature control performance of GDB161.9../6W actuators (with 6-port ball valves VWG41.. / VWG42.. or 6-port PICV VWPG51..):

- RDG26..KN.. with product index D or higher
- RDG26..T with product index Z, A or higher

Check the device version compatibility in Control output configuration for 6-port valve (P201) [→ 128] for applications with older RDG product indices, GDB161.9E or competitor actuators.

2.5 Integration via KNX bus

The RDG2..KN room thermostats can be integrated as follows:

- Integration into Synco 700 system via LTE-Mode (easy engineering)
- Integration into Desigo via group addressing (ETS) or individual addressing
 - Max. 60 RDG2..KN per line and do not mix RDG2..KN with other KNX products on the same line
- Integration into Desigo CC via IP router
- Integration into PXC system via KNX PL-Link
- Integration into third-party systems via group addressing (ETS)

The following KNX functions are available:

- Central time program and setpoints, e.g., when using the RMB795B central control unit
- Outside temperature or time of day via bus displayed on thermostat
- Remote operation and monitoring with web browser using the OZW772 web server
- Maximum energy efficiency due to exchange of relevant energy information, e.g., with Synco 700 controllers (e.g., heating demand, cooling demand)
- Alarming, e.g., external fault contact, condensation, clean filter, and so on
- Monitoring input for temperature sensor or switch

Engineering and commissioning can be done by using:

- Local DIP switches and HMI
- Synco ACS
- ETS5 or higher versions
- ABT Site or ABT Go (RDG2..KN)
- Siemens smartphone application PCT Go

Synco 700

The RDG2..KN room thermostats are especially tailored for integration into the Synco 700 system and operate together in LTE-Mode. This extends the field of use of Synco for individual room control in conjunction with fan coil units, chilled ceilings and radiators.

Synco topology

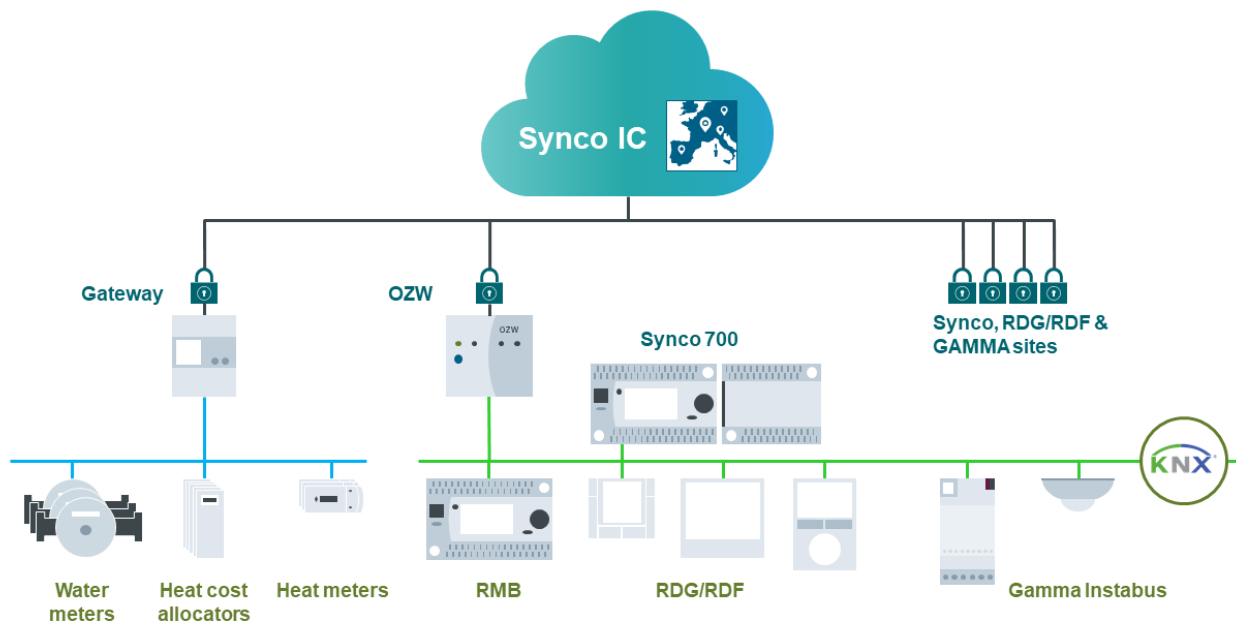

Legend

Synco 700	Building automation and control system (BACS)
Gateway	Connection of meters via Modbus
OZW	Web server, connection of Synco, RDG/RDF & GAMMA
RMB	Central control, RDG/RDF integration
RDG/RDF	Thermostats for room climate control
Gamma Instabus	For lighting control and other room electrical applications

Design topology

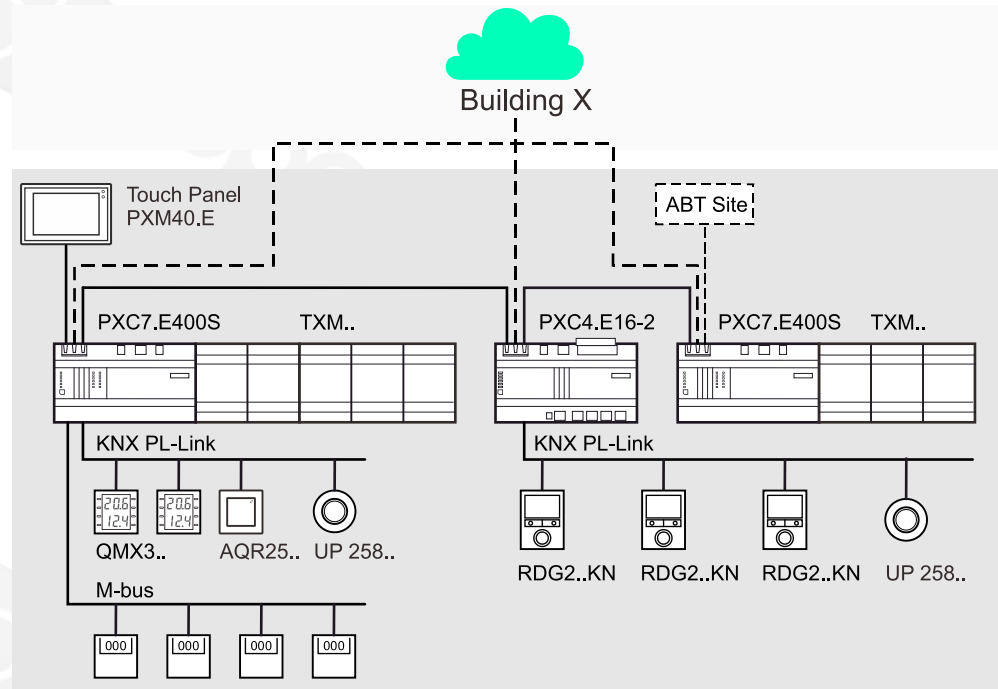

Legend

PXM40.E	Touch panel
ABT Site	Commissioning tool
PXC4.., PXC7..	Compact automation station
TXM..	Relay module
QMX3..	Room operator unit
AQR25..	Room sensor
UP 258..	Presence detector
RDG2..KN	Thermostats for room climate control

Design and third-party systems

The RDG2..KN thermostats can be integrated into the Siemens building automation and control systems (BACS) Designo or into third-party systems. Either S-Mode (group addressing) or individual addressing can be used for integration.

3 Notes

3.1 Mounting and installation

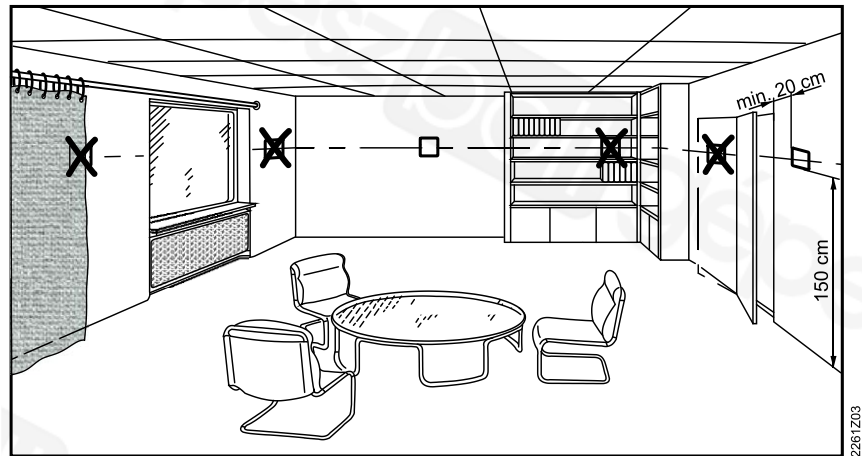

Mounting

- The devices are suitable for wall mounting.
- ⚠ **Warning! Do not mount the device on a metallic surface: Use mounting adapter ARG200 where this is not possible.**
- Recommended height: 1.5 m above the floor.
- Do not mount the devices in recesses, shelves, behind curtains or doors, or above or near heat sources.
- Avoid direct solar radiation and drafts.
- Avoid unheated (uncooled) building area such as outside walls.
- Seal the conduit box or the installation tube if any, as air currents can affect sensor readings.
- Adhere to allowed ambient conditions.
- An external room temperature sensor is recommended if above situations cannot be avoided in the installation area.

Wiring

- Comply with local regulations to wire, protect and earth the thermostat.
- ⚠ **Warning! No internal line protection for supply lines to external consumers (Q1, Q2, Q3, Yx or Yxx)! Risk of fire and injury due to short-circuits!**
- Adapt the line diameters as per local regulations to the rated value of the installed over current protection device.
- The AC 230 V mains supply line must have an external circuit breaker with a rated current of no more than 10 A.
- ⚠ Properly size the cables to the thermostat, fan and valve actuators for AC 230 V mains voltage.
- ⚠ Use valve actuators rated for AC 230 V / AC 24 V / DC 24 V depending on mains voltage.
- ⚠ Inputs X1-M, X2-M or U1-M (RDG2..KN) / X3-M (RDG2..T): Multiple switches (e.g. summer/winter switch) may be connected in parallel. Consider overall maximum contact sensing current for switch rating.
- ⚠ When mains voltage is AC 230 V, SELV inputs X1-M, X2-M and U1-M (RDG2..KN) / X3-M (RDG2..T) use cables with min. 230 V insulation.
- Selectable relay function: Follow instructions in basic documentation A6V11545892 (Relay functions [→ 196]) to connect external equipment to the relay outputs.

- ⚠ Disconnect thermostat from power supply before removing from the mounting plate.
- ⚠ RDG2..KN: If a KNX bus power supply is connected to the line with communicating thermostats and Synco controller, the internal KNX power supply of the Synco controllers must be switched off.

3.2 Commissioning

Applications and settings

The room thermostats are delivered with a fixed set of applications and related parameters. Select and activate the relevant application and settings during commissioning using one of the following tools:

- Local DIP switches and HMI
- Synco ACS (RDG2..KN)
- ETS5 or higher versions (RDG2..KN)
- ABT Site or ABT Go (RDG2..KN)
- Siemens smartphone application PCT Go

DIP switches

Set the DIP switches before snapping the thermostat to the mounting plate when selecting an application via DIP switches.

Set all DIP switches to Off (remote configuration) when selecting an application via commissioning tool.

After power is On, the thermostat resets and all LCD segments light up, indicating that reset is correct. After the reset of 3 seconds, the thermostat is ready for commissioning by qualified HVAC staff.

If all DIP switches are Off, **NO APPL** displays, indicating that application commissioning via a tool is required.

Commissioning via Siemens smartphone application PCT Go

The Siemens smartphone application Product Commissioning Tool (PCT Go) is a commissioning tool that allows users to:

- Read and write parameters of the thermostats
- Set the application (e.g. 2-pipe)
- Change settings (e.g. setpoints)
- Set the KNX addressing (device address) (RDG2..KN)

PCT Go app works via NFC (Near Field Communication) and can be used while the device is either powered, or unpowered, even from the individual package.

To read or write settings, NFC must be activated on the smartphone and the phone must be close to the NFC antenna (built into the thermostat), i.e. at a distance up to ± 2 cm.

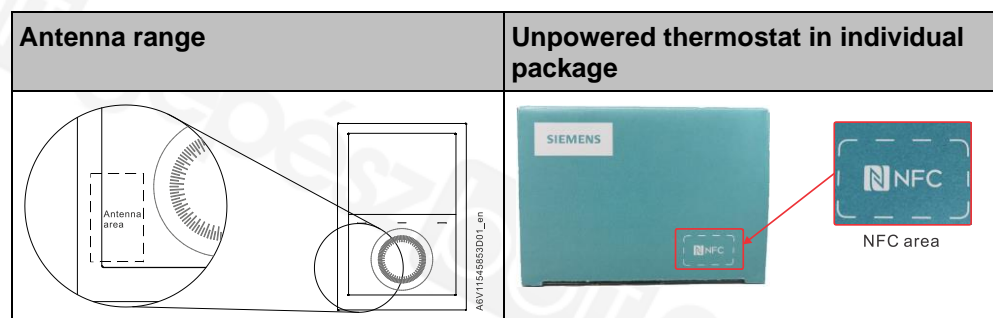

See also Commissioning parameter via Smartphone app PCT Go [→ 165]

Connect tools (RDG2..KN)

Connect the Synco ACS or ETS tools to the KNX bus cable at any point for commissioning.

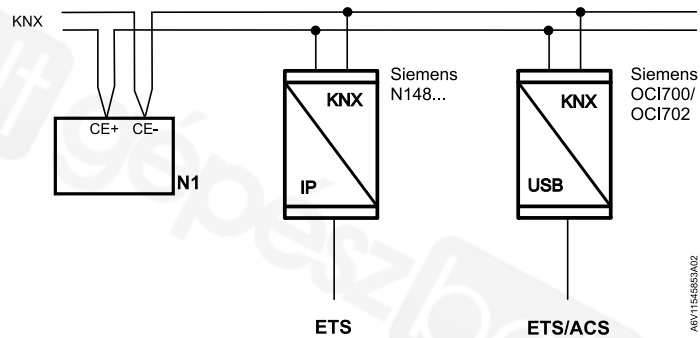

ACS and ETS require an interface:

- KNX interface (e.g. Siemens N148...)
- OCI702 USB-KNX interface

Control sequence

Set the control sequence via parameter P001 depending on the application.
Factory setting:

Application	Factory setting P001
2-pipe and chilled/heated ceiling, and 2-stage	1 = cooling only
4-pipe, chilled ceiling and el. heater, 6-port ball valve applications, and 2-stage	4 = heating and cooling

Calibrate sensor

Recalibrate the temperature sensor (internal and external), if the room temperature displayed on the thermostat does not match the room temperature measured (after min. 1 hour of operation). To do this, change parameter P006.

Setpoint and range limitation

We recommend to review the setpoints and setpoint ranges (P011, P013...P016, P019, P020) and change them as needed to achieve maximum comfort and save energy.

Programming mode (RDG2..KN)

The programming mode helps identify the thermostat in the KNX network during commissioning.

Touch both the left and right buttons simultaneously for 6 seconds to activate programming mode, indicated on the display by **PROG**.

Programming mode remains active until thermostat identification is complete.

Assign KNX address (RDG2..KN)

Assign complete KNX address (area, line and device) via:

- HMI or Siemens smartphone application PCT Go by setting parameters P898 (area address), P899 (line address) and P900 (device address)
- ACS, ETS (P900: device address)

Set the device address to 255 to deactivate the communication (no exchange of process data).

With the PL-Link integration into PXC4, 5 and 7, KNX address is assigned and set automatically via system.

Assign KNX group address (RDG2..KN)

Use ETS to assign the KNX group addresses of the thermostat's communication objects.

KNX serial number (RDG2..KN)

Each device has a unique KNX serial number on the rear.

An additional sticker with the same KNX serial number is enclosed in the package. This sticker is intended for documentation purposes of installers.

3.3 Operation

The room thermostat consists of two parts:

- Plastic housing with electronics, operating elements and room temperature sensor
- Mounting plate with the screw terminals

The housing engages in the mounting plate and is secured with 2 screws.

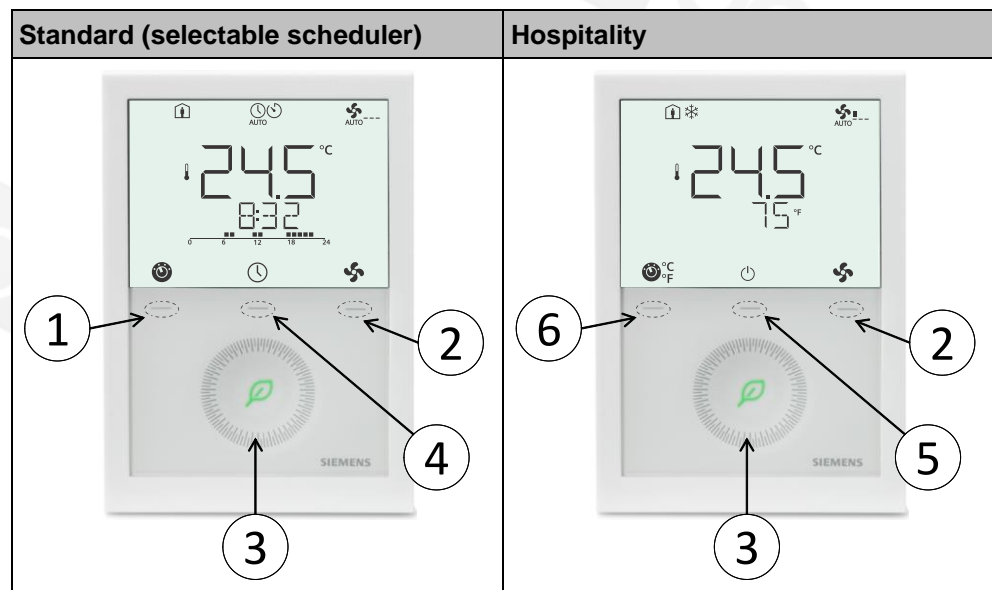
Layout**Note**

RDG2..T does not have Green leaf indicator.

Number	Description
①	Operating mode button/Esc
②	Fan mode button/OK
③	Capacitive rotary knob to adjust setpoints and parameters
④	Local schedule setting button, the schedule is enabled via P005
⑤	Protection hospitality mode button
⑥	Unit switching between °C and °F

Button operation

User action	Effect, description
Normal operation	Actual operating mode and state are indicated by symbols.
Press any button (thermostat in normal operation)	Enter operating mode selection; backlit LCD turns on, all possible mode symbols turn on, indicator element (arrow, P001 = 3) displays the current mode/state.

User action	Effect, description
Press left button	Operating mode, indicator element (arrow, P001 = 3) changes to the next mode symbol. After the last press and a timeout of 3 seconds, the newly selected mode is confirmed, the other elements disappear. After a timeout of 20 seconds, the LCD backlight turns off.
Press left button (P001 = 3)	Toggle between heating and cooling.
Press left button (P002 = 3 and P009 = 1)	Toggle between °C and °F (for details, see Temperature control [→ 30])
Press left button while "Operating mode" via bus is Economy	Activate "Extend Comfort mode" (for details, see Different ways to influence operating mode [→ 36]).
Keep left button pressed and turn rotary knob clockwise/counter-clockwise	Activate timer "Extend presence"/"Extend absence" and set the time (for details, see Different ways to influence operating mode [→ 36]).
Press right button >3 seconds	Activate/deactivate button lock.
Press right button for fan coil unit	Change fan mode.
Turn rotary knob	Adjust the room temperature Comfort setpoint.
Press left and right buttons simultaneously for 3 seconds. Release and within 2 seconds, press the right button again until P001 is displayed	Enter parameter setting mode "Service level".
Press left and right button for 3 seconds, release, press left button for 2 seconds until the temperature disappears, then turn rotary knob counterclockwise min. ½ revolution	Enter parameter setting mode "Expert level", diagnostics and test.
Press left and right button simultaneously for 6 seconds	RDG2..KN: Enter (KNX) programming mode.
Press the middle button once and turn rotary knob	Enter programming mode PROG, TIME, DATE or AWAY.

Display

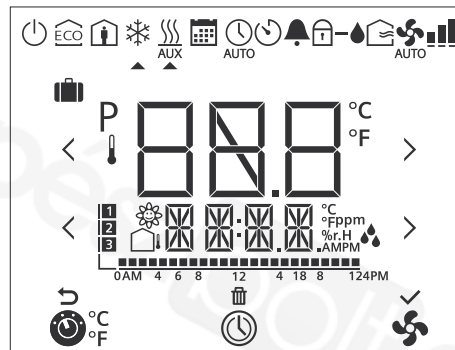

#	Symbol	Description	#	Symbol	Description
1		Operating mode selection/Unit switching	2		Scheduler
3		Fan speed selection	4		Escape
5		Delete schedule	6		Confirm parameters
7		Time bar for schedule	8		Number of schedules or subordinate alarms
9		Indoor air quality	10		Outside temperature
11		Additional user information, such as outside temperature, time of day from KNX bus, relative humidity, or IAQ	12	AMPM	Morning: 12-hour format Afternoon: 12-hour format
13		Relative humidity	14		Degrees Celsius or Fahrenheit
15		CO ₂ values	16	P	Parameter
17		Value with thermometer: Digits for room temperature display	18		Digits for setpoint display
19		Holiday mode	20		Protection mode
21		Economy mode	22		Comfort mode
23		Cooling mode	24		Heating mode, electric heater active
25		Heating mode	26		Manual changeover, heating/cooling mode
27		Scheduler mode	28		Auto mode
29		Temporary timer	30		Fault
31		Button lock	32		Condensation in room (dewpoint sensor active) or humidity control active
33		Fresh air indication	35		Fan speed I
34		Automatic fan			Fan speed II
					Fan speed III

3.4 Remote operation

The RDG.. room thermostats can be operated from a remote location using the OZW772 web server or the ACS tool.

3.5 Disposal



This symbol or any other national label indicate that the product, its packaging, and, where applicable, any batteries may not be disposed of as domestic waste. Delete all personal data and dispose of the item(s) at separate collection and recycling facilities in accordance with local and national legislation. For additional details, refer to www.siemens.com/bt/disposal.

3.6 Cyber security disclaimer

Siemens provides a portfolio of products, solutions, systems and services that includes security functions that support the secure operation of plants, systems, machines and networks. In the field of Building Technologies, this includes building automation and control, fire safety, security management as well as physical security systems. In order to protect plants, systems, machines and networks against cyber threats, it is necessary to implement – and continuously maintain – a holistic, state-of-the-art security concept. Siemens' portfolio only forms one element of such a concept.

You are responsible for preventing unauthorized access to your plants, systems, machines and networks which should only be connected to an enterprise network or the internet if and to the extent such a connection is necessary and only when appropriate security measures (e.g. firewalls and/or network segmentation) are in place. Additionally, Siemens' guidance on appropriate security measures should be taken into account. For additional information, please contact your Siemens sales representative or visit:

<https://www.siemens.com/global/en/home/company/topic-areas/future-of-manufacturing/industrial-security.html>

Siemens' portfolio undergoes continuous development to make it more secure. Siemens strongly recommends that updates are applied as soon as they are available and that the latest versions are used. Use of versions that are no longer supported, and failure to apply the latest updates may increase your exposure to cyber threats. Siemens strongly recommends to comply with security advisories on the latest security threats, patches and other related measures, published, among others, here:

<https://www.siemens.com/cert/> => 'Siemens Security Advisories'

4 Functions

4.1 Temperature control

General note: Parameters

Setting control parameters (P001 etc. mentioned throughout the document), see Control parameters [→ 163].

Temperature control

The thermostat acquires the room temperature via built-in sensor, external room temperature sensor (LG-Ni1000 or NTC 3k), external return air temperature sensor (LG-Ni1000 or NTC 3k) or via KNX (S-Mode or LTE-Mode), and maintains the setpoint by delivering actuator control commands to heating equipment, cooling equipment, or both. The following control outputs are available:

- On/Off control (2-position)
- Modulating PI/P control with PWM output
- Modulating PI/P control with 3-position control output
- Modulating PI/P control with DC 0...10 V control output

The switching differential is 1 K for heating/cooling mode (On/Off valve: P051 and P053).

The proportional band is 2 K for heating mode and 1 K for cooling mode (DC, PWM and 3-pos valves: P050 and P052).

The integral action time for modulating PI control is adjustable via P057 (heating) and P058 (cooling) (factory setting: 45 minutes).

Display

The display shows the acquired room temperature or the Comfort setpoint, selectable via P008. The factory setting displays the current room temperature. Configure P004 to display the room temperature or setpoint in °F or °C as needed. When P002 = 3, switch the unit between °C and °F via operating mode button, and the symbol is displayed as  °F. When the unit is changed, P004 is updated accordingly. This function is only available from product index C or a higher version.

Note

When P008 = 1, the Comfort setpoint is always displayed even when the operating mode changes.







The acquired room temperature (internal or external sensor) is available as information on the bus.

RDG2..KN can also acquire the room temperature via KNX.



Room temperature



- With automatic changeover or continuous heating/cooling, symbols  /  indicate that the system is currently in heating or cooling.
- With manual changeover (P001 = 3), symbols  /  indicate that the system currently is in heating or cooling mode and symbols  /  indicate that the system is currently in heating or cooling. Thus, the symbols are displayed even when the thermostat operates in the neutral zone.

Concurrent display of °C and °F

Concurrent display of the current room temperature setpoint or current room temperature in °C and °F is available (P009 = 1).



Outside temperature via bus

The outside temperature displays on the thermostat (P009 = 2). This temperature value has only informational character.

In LTE-Mode, the outside temperature can only be received on outside temperature zone 31.

In S-Mode, the corresponding communication object must be bound to a KNX sensor device.

4.2 Operating modes



**Room operating mode:
State**

The thermostat operating mode can be influenced in different ways (see Different ways to influence operating mode [→ 32]). Specific heating and cooling setpoints are assigned to each operating mode.

The thermostat sends the current room operating mode via bus. (RDG2..KN)

The following operating modes are available:

	Operating mode	Icon	Description
	Auto		In Auto mode, the operating mode is commanded via bus or local schedule. Auto is replaced by Comfort when no time schedule via bus is present.
 Room operating mode: Presence detector	Comfort		In Comfort mode, the thermostat maintains the Comfort setpoint. This setpoint can be defined via P011, P013...P016, and adjusted via the rotary knob or bus. In Comfort mode, the fan can be set to automatic or manual fan speed: I, II or III. The thermostat switches to Comfort mode when: <ul style="list-style-type: none"> Standard presence mode: The presence detector (local or via KNX) is active (room is occupied) *)
 Room operating mode: Presence detector	Economy		The setpoints (more energy savings than in Comfort mode) can be defined via P019 and P020. The thermostat switches to Economy mode when: <ul style="list-style-type: none"> The operating mode button is pressed (only possible if P002 is set to 2), Economy is sent via bus, Hotel presence mode: When hotel guests leave their rooms, the thermostat switches to Economy. The buttons are locked and symbol displays. *)
 Room operating mode: Window contact	Protection		In Protection mode, the system is: <ul style="list-style-type: none"> Protected against frost (factory setting: 8 °C, configurable via P100) Protected against overheating (factory setting: OFF, configurable via P101) No other operating mode can be selected locally if Protection mode is commanded by time schedule via bus (e.g., from a central control unit RMB795B) and is displayed. The thermostat switches to Protection mode when: <ul style="list-style-type: none"> The operating mode button is pressed Protection is sent via bus The window contact is active (open window) "Window contact" is sent to thermostat via bus, e.g., from a KNX switch *)

Note

*) For details on window contact and presence detector, see Different ways to influence operating mode [→ 32].

4.2.1 Different ways to influence operating mode

Source for change of operating mode



ACS

Different interventions can influence the operating mode.

The source of the actual room operating mode state can be monitored using the "Cause" diagnostic data point in the ACS tool or web server OZW772. (RDG2..KN)

Source	Description	Value of data point "Cause"
Local operation via left button	<ul style="list-style-type: none"> Operating mode is not Auto No time schedule via bus 	Room operating mode selector (preselection)
	Local time schedule	Local schedule
	Temporary Comfort extension is active	Timer function
	Window contact	Window contact
	Presence detector	Presence detector
 Room op. mode (RDG2..KN)	"Window contact" sent via bus	Window contact
	"Presence detector" sent via bus	Presence detector
	<ul style="list-style-type: none"> Time schedule available via bus <ul style="list-style-type: none"> local operating mode is set to Auto Time schedule sends Protection mode via bus <ul style="list-style-type: none"> operating mode cannot be changed locally 	Time switch

Priority of operating mode interventions

The following table shows the priorities of different interventions.

A lower number means higher priority.

Priority	Description	Remark
①	Commissioning	In parameter setting mode, you can always command an operating mode independent of all other settings or interventions via bus and local input.
②	Protection mode via bus from time schedule (RDG2..KN)	Protection mode, sent by a time schedule, cannot be overridden by the users.
③	Window contact	If the contact is closed, the operating mode changes to Protection. This overrides the operating mode on the thermostat.
③	"Window contact" via bus (RDG2..KN)	"Window contact" sent via bus has the same effect as the local window contact. Note: Only one input source must be used, either local input X1/X2/U1 or KNX bus.

Priority	Description	Remark
④	Presence detector	<ul style="list-style-type: none"> Standard presence mode: If a room is occupied, the operating mode changes to Comfort. This overrides the operating mode on the thermostat. Unoccupied rooms set back the thermostat to the previous operating mode. Hotel presence mode: If a room is unoccupied, the operating mode changes to Economy. This overrides the operating mode on the thermostat. The buttons are locked and symbol  displays. Occupied rooms set back the thermostat to the previous operating mode.
④	Presence detector via bus (RDG2..KN)	<p>"Presence detector" sent via bus has the same effect as the local presence detector.</p> <p>Note: Only one input source must be used, either local input X1/X2/U1 or KNX bus.</p>
④	Operating mode button	Users can change the operating mode using the operating mode button.
④	Operating mode via bus (RDG2..KN)	The operating mode can be changed via bus.
④	Temporary extended Comfort mode via operating mode button	<p>The operating mode can be temporarily changed from Economy to Comfort by pressing the operating mode button, if...</p> <ul style="list-style-type: none"> Economy was sent via bus For an extended Comfort period > 0 (P102) <p>Note: The last option selected is used, either locally or using bus.</p>
④	Local time schedule	When P005 = On (Enabled), the local time schedule is active. The thermostat does not react to the operating mode: time switch command from the bus. The operating mode set via local time schedule can be overridden by all other interventions.
④	Time schedule via bus (RDG2..KN)	<p>When P005 = Off (Disabled), the bus schedule is active. The operating mode sent via bus can be overridden by all other interventions.</p> <p>Exception: Protection mode has priority 2.</p> <p>Note: If the time schedule switches from Comfort to Economy, but the presence detector is still active (room occupied), the thermostat continues to work in Comfort mode until the room is unoccupied.</p>



Auto mode with time schedule via bus (RDG2..KN)

Recommended for commercial building applications, e.g. for offices, shops, etc.

If a time schedule via bus is present, e.g., from a central control unit, Auto mode



AUTO is active. The thermostat automatically changes to Comfort, Economy or Protection according to the time schedule via bus.

The display shows the Auto mode symbol  along with the symbol for the actual room operating mode (Comfort  or Economy .

You can change the operating mode by pressing the operating mode button. The selected operating mode remains "temporary" until command "Room operating mode: Time switch" is received.

When the thermostat automatically operates in Economy, users can set the thermostat to Comfort via HMI when:

- P002 (operation via operating mode selector) is set to 2 (Auto – Comf -Eco – Prot)
- P002 = 1 or 3, and P102 (temporary Comfort mode) is enabled

Automatic fan is the default fan speed in Auto mode.

Note

"Temporary" means that the operating mode can be changed automatically, e.g. receives a new command from the bus until the next switching point.

Auto mode with local time schedule

Recommended for residential applications

If a local time schedule is enabled (P005 = ON), e.g., Auto mode  is active. The thermostat automatically changes to Comfort, Economy according to the local time schedule.

The display shows the Auto mode symbol  along with the symbol for the actual room operating mode (Comfort  or Economy .

You can change the operating mode by pressing the operating mode button. The new selected operating mode remains "permanent" until the next user intervention or a new preselection mode is received from bus.

Operating mode Protection hospitality (P002 = 3) is not available with the local time schedule.

Automatic fan is the default fan speed in Auto mode.

Note

"Permanent" means the operating mode change needs user intervention, e.g. HMI operation, or a new preselection mode is received from bus.

Behavior when bus sends new operating mode (RDG2..KN)

With time schedule via bus, each time the time schedule sends a new operating mode (switching event), the operating mode of the thermostat is set back to Auto mode. This ensures that the room temperature is maintained according to the time schedule. (not valid when the local time schedule is enabled: P005 = ON)

Pre-Comfort via bus (RDG2..KN)

If the time schedule sends Pre-Comfort mode, the mode is changed either to Economy (factory setting) or Comfort (selectable via P910).

Behavior when bus sends Protection (RDG2..KN)

No intervention is possible by the users, if Protection mode is set by the time schedule. **OFF** flashes on the display when a button is pressed.

Availability of Economy mode

The operating mode can be selected locally via the operating mode button. The behavior of the operating mode button (user profile) can be defined via P002, factory setting is P002 = 1.

P002	Available op. mode	End user op. mode button	Description
Schedule via bus (RDG2..KN)			
1			Recommended for commercial buildings: <ul style="list-style-type: none"> Switching manually between modes by pressing the operating mode button User settings are temporary and valid until the next switching event Economy is not available
3			Note: Comfort mode can be temporarily extended (P102) (see Different ways to influence operating mode [→ 36])
2			Recommended for commercial buildings or rooms where manual switching to Economy mode is desired: <ul style="list-style-type: none"> Switching manually between modes by pressing the operating mode button User settings are temporary and valid until the next switching event
Local schedule (P005 = ON, RDG2..KN)			
1			Recommended for residential buildings or apartments: <ul style="list-style-type: none"> Switching manually between modes by pressing the operating mode button Economy is available only with P002 = 2 User settings for Protection mode are permanent and valid until the next user intervention or a new preselection mode from the bus
2			
3	N/A		
Local schedule (P005 = ON, RDG2..T)			
1			Recommended for residential buildings or apartments: <ul style="list-style-type: none"> Switching manually between modes by pressing the operating mode button Economy is available only with P002 = 2 User settings for Protection mode are permanent and valid until the next user intervention
2			
4			
3	N/A		
Without time schedule			
1			For residential buildings or apartments where the schedule is not requested: <ul style="list-style-type: none"> Switching manually between modes by pressing the operating mode button Economy is available only with P002 = 2 User settings are permanent and valid until the next user intervention
2			
3			Recommended for hotel guest rooms or apartments: <ul style="list-style-type: none"> Switching manually between modes by pressing the operating mode button User settings are permanent and valid until the next user intervention or a new preselection mode from the bus

Window contact
**Room operating mode:
Window contact
(RDG2..KN)**

The thermostat is forced into Protection mode when the window is open. The contact can be connected to multifunctional input X1, X2 or U1. Set P150, P153 or P155 to 3. User operations are ineffective and **OFF** displays if the window contact is active.

The window contact function is also available via the KNX signal "Window contact", e.g., from a KNX switch or a KNX presence detector.

**Presence detector
(RDG2..KN)**
**Temporary timer to
extend Comfort mode**

The operating mode can be changed to Comfort or Economy based on room occupancy (room occupied or unoccupied, via presence detector or keycard).

For details, see Presence detector [→ 56]

Comfort mode can be temporarily extended (e.g., working after business hours or on weekends) when the thermostat is in Economy mode.

1. Press the operating mode button to return to Comfort for the preset period (P102).
2. Press the operating mode button again to stop the schedule.

The following conditions must be fulfilled:

- Room is unoccupied (via bus)
or
mode selection via operating mode button is set to "Auto (Comfort)-Protection" (P002 = 1) or "Auto (Comfort)-Protection Hospitality" (P002 = 3) and the time schedule via bus is Economy
- P102 (extend Comfort period) is greater than 0

During the temporary Comfort mode extension, symbol ☺ displays.

When P102 (extend Comfort period) equals 0, extended Comfort cannot be activated; pressing the left button will switch the thermostat to Protection.

If the operating mode window contact is active, press the left button and **OFF** displays (blinking).

**Timer to extend
presence/absence**



The actual room operating mode can be forced temporarily to Comfort or Economy/Protection. The time period is adjusted via the rotary knob:

- Extend presence: Set the thermostat to Comfort for the selected time
- Extend absence: Set the thermostat to Economy/Protection for the selected time

To activate the function, press and hold the left button and, within 3 seconds, turn the rotary knob...











- clockwise for extended presence
- counterclockwise for extended absence

The rotary knob adjusts the time period:

- Extend presence: 0:00...+9:30 in steps of 30 minutes; the symbol  is displayed
- Extend absence: 0:00...-9:30 in steps of 30 minutes; the symbol  or  is displayed











During the extended presence/absence periods, symbol ☺ is displayed.

Function if no time schedule is received via bus

User profile for operating mode (selected via P002)	Operating mode when activating function	Mode button	Function	Operating mode during function	Operating mode at the end of function
P002 = 1:  	Comfort		Extension	Comfort	Protection
	Comfort		Absence	Protection	Comfort
P002 = 2:   	Comfort or Economy		Extension	Comfort	Economy
	Comfort or Economy		Absence	Economy	Comfort
P002 = 3:  	Comfort		Extension	Comfort	Protection hospitality
	Comfort		Absence	Protection hospitality	Comfort

Note

Extension/absence is not available in Protection mode.
Function with time schedule via bus (RDG2..KN)

User profile for operating mode (selected via P002)	Operating mode when activating function	Mode button	Function	Operating mode during function	Operating mode at the end of function
P002 = 1:   <small>AUTO</small>	Auto		Extension	Comfort	Auto
	Comfort		Extension	Comfort	Auto
	Auto		Absence	Protection	Auto
	Comfort		Absence	Protection	Auto
P002 = 2:     <small>AUTO</small>	Auto, Comfort or Economy		Extension	Comfort	Auto
	Auto, Comfort or Economy		Absence	Economy	Auto
P002 = 3:   <small>AUTO</small>	Auto		Extension	Comfort	Auto
	Comfort		Extension	Comfort	Auto
	Auto		Absence	Protection hospitality	Auto
	Comfort		Absence	Protection hospitality	Auto

Note

Extension/absence is not available in Protection mode.

4.2.2 Communication examples

The following examples show 3 typical applications for a central time schedule together with local control of the room operating mode.

The room operating mode in rooms 1...3 of a building is determined by the time schedule. Window contacts are installed in all rooms.

The following conditions are specified:

The rooms are used and controlled by the time schedule as follows:

- Night setback from 17:00 to 08:00 (Economy)
- Lunch break from 12:00 to 13:00 (Pre-Comfort)

The substitution (P910) for Pre-Comfort via bus is set on the thermostats as follows:

- Room 1: Comfort (1)
- Room 2: Economy (0)

Example 1

Window contact

In **Room 1**, the window is opened briefly, once in the morning and once in the late afternoon (1). The opening in the morning and afternoon directly influences the actual room operating mode.

During lunch break (2), the time schedule changes to Pre-Comfort. The mode remains in Comfort as set by parameter "Transformation Pre-Comfort" (P910 = 1).

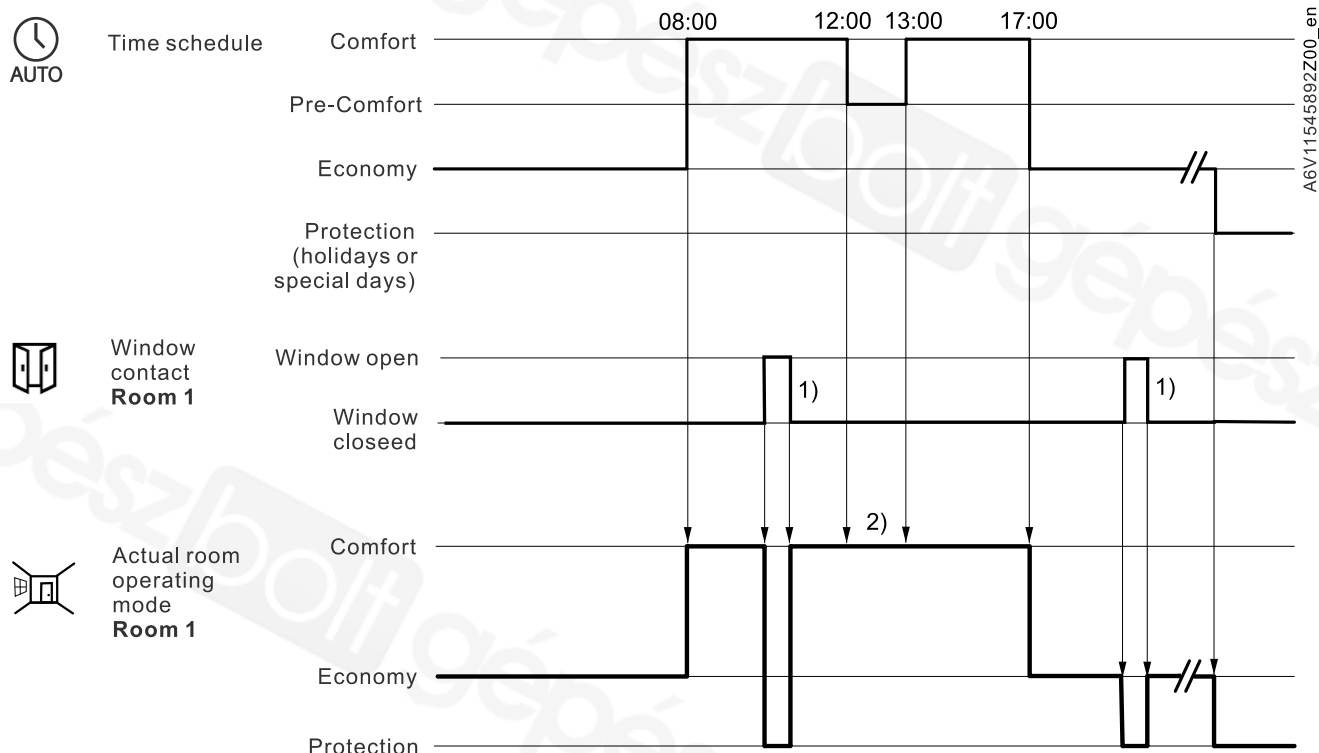

Example 2

Interaction of user operation (operating mode button) and central time schedule

In **Room 2**, the window is opened briefly, once in the morning and once in the late afternoon (1).

Only the opening in the morning directly influences actual room operating mode.

With the operating mode button, the operating mode can be changed between OFF and Auto or to temporary Comfort extension.

- During lunch break, the time schedule changes to Pre-Comfort. The thermostat mode changes to Economy as set by parameter "Transformation Pre-Comfort" (P910 = 0) (6)
- During lunch break, the user changes the operating mode to Comfort (temporary Comfort extension) by pressing the operating mode button (2)
- At 13:00, the timer is reset due to mode change by the central time schedule
- In the afternoon, the user switches off the thermostat by pressing the operating mode button (3). At 17:00 the user setting is reset to Economy by the time schedule
- At 19:30, the user again extends Comfort mode (4)

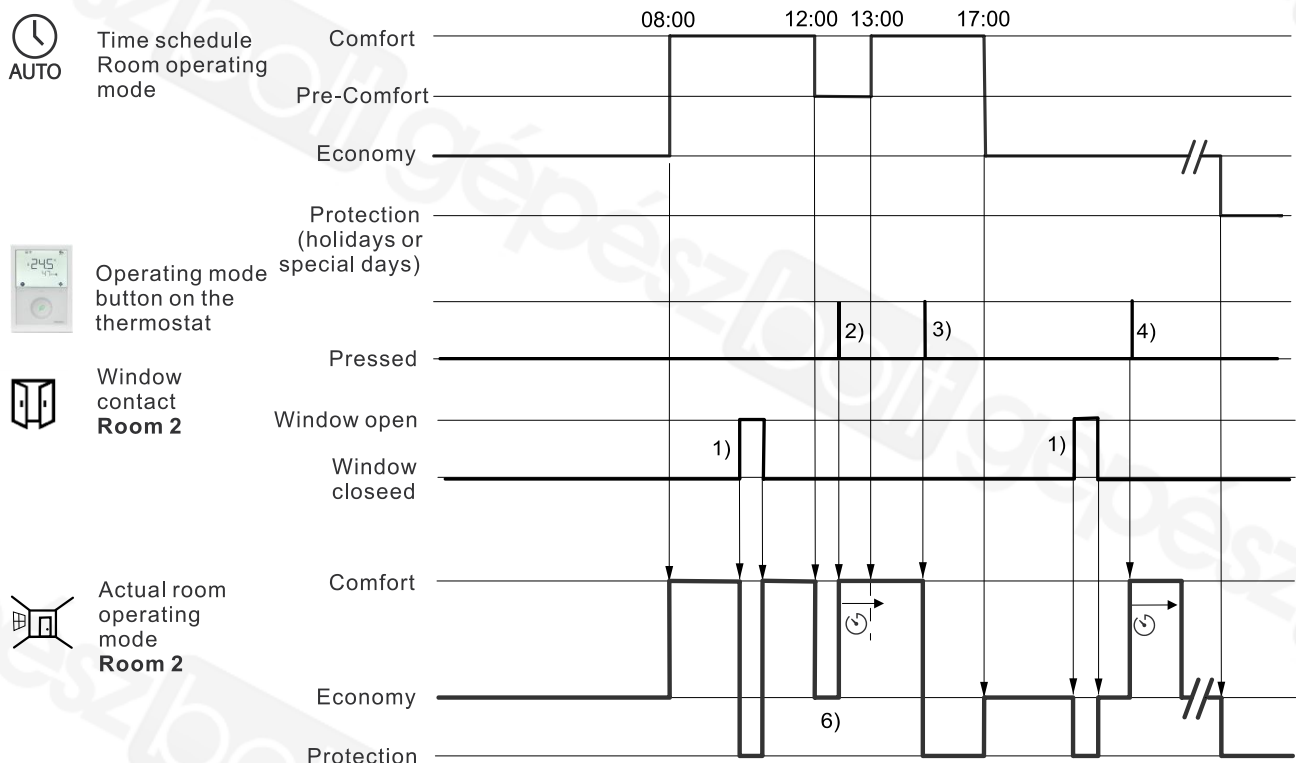

Example 3

Application for "Window contact", "Presence detector" and "Central time schedule"

In **Room 3**, the time schedule is between 13:00 and 17:00.

- In the morning, as soon as presence is detected, the operating mode switches to Comfort (1)
- The users open the window briefly and the operating mode switches to Protection (2)
- In the afternoon, the central time schedule sets Comfort mode from 13:00 to 17:00 (3)
- After 17:00, the room is still occupied, and the operating mode remains in Comfort (occupancy via presence detector) (4)
- The users open the window and exit the room for a short time. The operating mode switches to Protection as long as the window is open (5)
- As soon as the room is unoccupied, the thermostat switches to Economy (6)
- After this time, occupancy detected by the presence detector has no effect, and the central time schedule sets the thermostat to Protection (7)

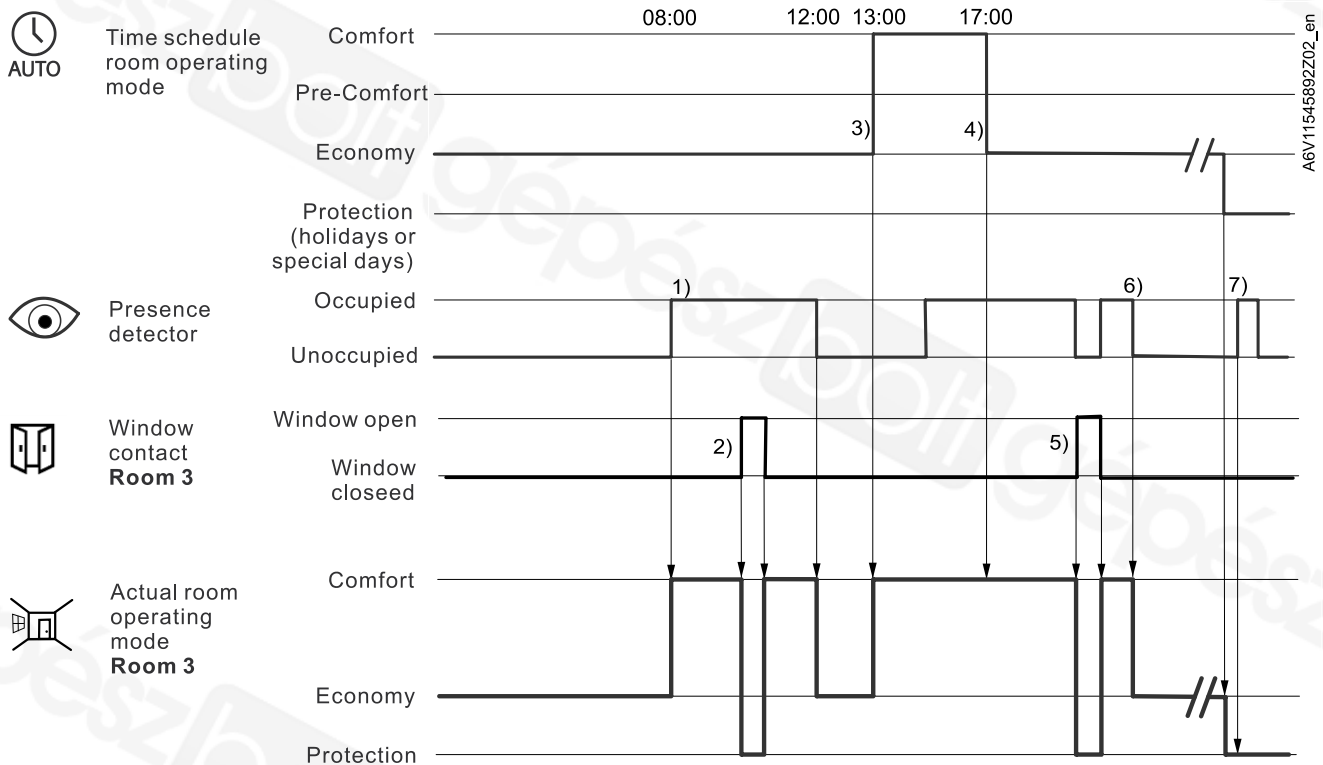

4.3 Room temperature setpoints

4.3.1 Description

Comfort mode



The factory setting for the Comfort basic setpoint is 21 °C and can be changed in the thermostat's EEPROM via P011, bus with communication object "Comfort basic setpoint" or Siemens smartphone application PCT Go. The last option selected is always used.

The Comfort setpoint can be adjusted via rotary knob, or bus from a remote device like a touch panel, operator unit, etc. The last option selected is used.

Temporary comfort setpoint (RDG2..KN)

When "Temporary comfort setpoint" is enabled via P103, the Comfort setpoint is set back to the Comfort basic setpoint stored in P011 only when the operating mode is changed.

If, e.g., the thermostat receives a new Comfort basic setpoint from the bus (object 25 - Room temp: Comfort basic setpoint), the current Comfort setpoint is not updated immediately. Only when the operating mode is set back to Comfort, the Comfort setpoint is updated with the new Comfort basic setpoint.

Note

This setback is only executed when the change of the operating mode is commanded

P103	Operating mode is commanded by
1	Pressing the mode button or via bus.
2	Pressing the mode button or via bus, not by window contact.
3	Pressing the mode button or via bus, not by presence detector and hotel presence detector (digital input or bus).

When "Temporary comfort setpoint" is disabled via P103, the Comfort setpoint is set back to the Comfort basic setpoint (stored in P011) immediately as soon as the Comfort basic setpoint is changed.

Setpoint limitation

For Comfort or energy saving purposes, the setpoint setting range can be limited by selecting the most appropriate setpoint concept:

- Setpoint Comfort concept (P010 = 1) for maximum user comfort
- Setpoint energy saving concept (P010 = 2) to save energy

Setpoint comfort concept (P010 = 1)

- The setpoint limit can be set via P013 (Comfort setpoint minimum) and P016 (Comfort setpoint maximum). Both heating and cooling setpoints are adjustable between these two limits.
- The user adjusts the desired setpoint and the thermostat controls the room temperature accordingly.
- For 4-pipe applications, the selected Comfort setpoint is in the middle of the dead zone (P055). The unit stops to energize the heating/cooling outputs as soon as the room temperature reaches the dead zone.

Example



Setpoint energy saving concept (P010 = 2)

- This allows users to limit the setpoint setting range for heating and cooling independently.
- The setpoint limits for heating can be set via P013 (Comfort setpoint minimum) and P014 (Comfort setpoint maximum heating). The setpoint limits for cooling can be set via P015 (Comfort setpoint minimum cooling) and P016 (Comfort setpoint minimum).

Example



- For 4-pipe applications:
 - The thermostat runs on the setpoint of the active sequence:
 - In heating mode, the heating setpoint is active and adjustable via rotary knob.
 - In cooling mode, the cooling setpoint is active and adjustable via rotary knob

- Switching from the heating setpoint to the cooling setpoint and vice-versa occurs when the room temperature reaches the adjusted limitation (P014 or P015) of the **inactive** sequence. E.g., the thermostat is in heating sequence and runs on the heating setpoint. When the room temperature reaches P015, the thermostat switches to cooling and runs on the cooling setpoint, as long as the room temperature does not drop below P014.

Absolute and relative setpoint (P104)

With the default setting (absolute setpoints) of the setpoint display, the Comfort setpoint is displayed as absolute temperature value, e.g. 22 °C and can be adjusted within the selected limitation. If the relative setpoint (P104 = 2) is selected, the Comfort setpoint can be adjusted via rotary knob from -3 K to +3 K.

The relative setting range $\pm 3K$ is fixed, but can be limited via P013 (min Comfort setpoint) and P016 (max Comfort setpoint) as needed.

During relative setpoint selection, the value is displayed on the 2nd line of the display.

The relative setpoint can be selected only when the Comfort concept (setpoint concept: P010 = 1) is selected.

Economy mode



Protection mode



Use P019 and P020 to adjust Economy mode setpoints.

The heating setpoint is 15 °C (factory setting), and the cooling setpoint is 30 °C.

Use P100 and P101 to adjust the Protection mode setpoints.

The heating setpoint is 8 °C (frost protection, factory setting) and OFF for cooling.

⚠ CAUTION



If a setpoint (Economy or Protection) is set to OFF, the thermostat does not control the room temperature in the corresponding mode (heating or cooling). As a result, there is no protective heating or cooling function and thus risk of frost during heating or risk of overtemperature during cooling!

The Economy setpoints (P019, P020) are accessible at the Service level; the Protection setpoints (P100, P101) are accessible at the Expert level.

4.3.2 Setting and adjusting setpoints

Room temperature setpoints can be...

- Set during commissioning
- Adjusted during runtime

The source can be one of the followings:

- Local HMI
- KNX tool (RDG2..KN)
- Central control unit
- Siemens smartphone application PCT Go

The thermostat saves the setpoints to:

- EEPROM in the form of parameters
- Runtime memory



Comfort basic setpoint

Comfort setpoint

Economy heating setpoint ⁴⁾

Economy cooling setpoint ⁴⁾

The figure below shows the interrelation:

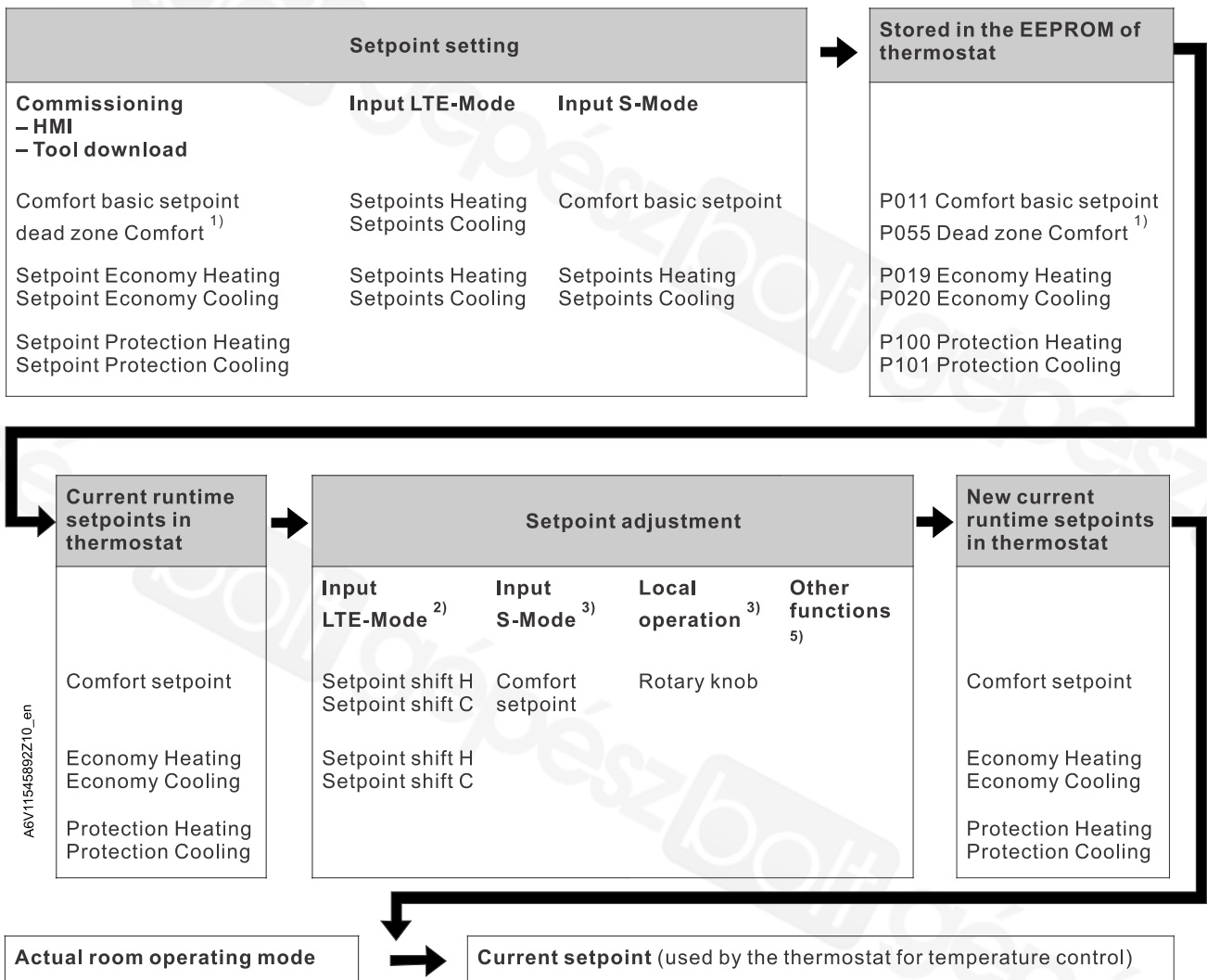

¹⁾ Only required for heating and cooling applications (see Setpoints and sequences [→ 122])

²⁾ LTE-Mode: **Shift is added** to the local shift

³⁾ S-Mode: **The last option selected is always used**, either S-Mode input or local operation

⁴⁾ To display the S-Mode objects of the Economy heating and cooling setpoint (P019/P020), set the control parameter "Room temperature: Economy setpoints" to **as group object** in ETS tool

⁵⁾ Other functions:

- If current humidity setpoint is not suitable for room humidity, setpoint shift is activated via humidity control strategy (P451).

Cooling setpoint tracking depending on outside temperature (P255)

In cooling mode, a large difference between outside and indoor temperatures can create discomfort and waste energy. The thermostat can track the outside temperature via the bus and adjust the cooling setpoint to make sure the difference is not too great. If the outside temperature is higher than 26 °C and 6 K above the Comfort cooling setpoint, the related setpoint is shifted and kept 6 K below the outside temperature. This function can be enabled or disabled via P255.

The current setpoint (used by the thermostat for temperature control) is available on the bus for use in the central control unit.



Clarification concerning current setpoint in Comfort mode

The Comfort setpoint w (e.g., customer setting on the display) and the current setpoint $w2$ (used by the thermostat for temperature control, but not displayed) are handled differently depending on the selected application and setting.

2-pipe with P010 = 1 or 4-pipe with P010 = 1 and P001 = 3

Both the Comfort setpoint w and current setpoint $w2$ have the same value.

Heating mode

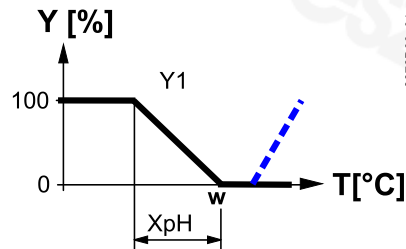

Cooling mode

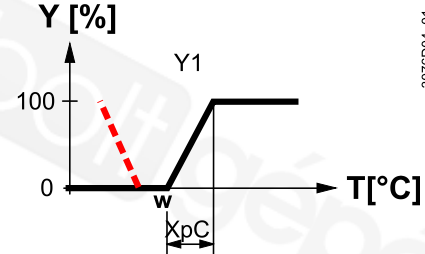

4-pipe with P010 = 1

The Comfort setpoint w (value selectable by e.g., rotary knob) is in the middle of the dead zone (P055). The current setpoints $w2..$ (used by the thermostat for temperature control) are at the boundaries of the dead zone.

$w2h = \text{Comfort setpoint } (w) - \frac{1}{2} \text{ dead zone } (X_{dz})$

$w2c = \text{Comfort setpoint } (w) + \frac{1}{2} \text{ dead zone } (X_{dz})$

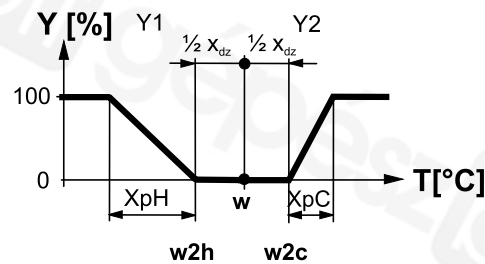

General notes

- The supported communication objects are different in LTE-Mode and S-Mode
- Changes via the local HMI or tools have the same priority (the last option is always used)
- Setting the Comfort basic setpoint resets the runtime Comfort setpoint only when P103 = 0

Notes on setpoint adjustment (LTE-Mode with Synco only (RDG2..KN))

- Central setpoint shifting is used for summer/winter compensation in particular
- Setpoint shifting does not influence the setpoints stored in P011, P019, P020 and P055
- Local and central shifts are added up
- Applies only to Comfort and Economy setpoints; Protection setpoints are not shifted centrally
- The current setpoint heating and cooling is limited by the Protection setpoint. If the Protection setpoint is Off, both the minimum 5 °C and maximum 40 °C are used
- The current setpoints for cooling and heating of the same operating mode have a minimum distance of 0.5 K
- The result of local and central shifting, together with room operating mode, humidity control or setpoint tracking for cooling, is used by the thermostat for temperature control (current setpoint)

Setpoint priority Setpoint manager (RMB)

- The room thermostat always takes over the setpoints received from the controller RMB795B. Thus, the setpoints adjusted locally on the thermostats are overridden by the setpoints from the room group (e.g., every 15 minutes)
 - On RMB, the circumstances under which the controller sends out the setpoints can be defined. Refer to CE1P3122 for "Setpoint priority" and "Setpoint Manager" functions

4.4 Application overview



The RDG2.. room thermostats support the following applications, which can be configured using the DIP switches at the rear of the unit or commissioning tool.

Remote configuration

Set DIP switches 1...5 (except for ABT Site: 1...9) to OFF (remote configuration, factory setting) to select an application via commissioning tool.



Note

If DIP switches 1...5 have been set on the device, RDG2.. only accepts the commissioning set of PCT Go, ACS or ETS when the same application is selected on the tool.

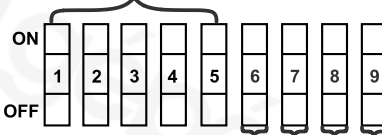
Remote configuration, via commissioning tool (factory setting) <ul style="list-style-type: none"> • Synco ACS (RDG2..KN) • ETS (RDG2..KN) • ABT Site (RDG2..KN) • Commissioning via Siemens smartphone application PCT Go 	ON =  DIP NO.: 1...9
	OFF =  DIP NO.: 1...9

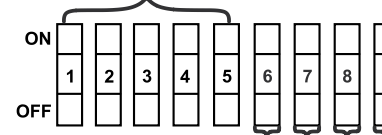
RDG20..	
Application	
	
Fan coil fan speed ON: 3-speed OFF: DC 0...10 V	
FCU control outputs #1 ON: 3-position OFF: 2-position	
FCU control outputs #2 ON: 3-position OFF: 2-position	
Scheduler ON: Enable OFF: Disable	

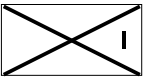
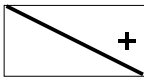
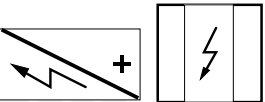
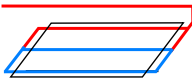
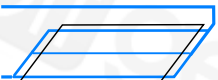
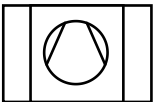
RDG26..	
Application	
	
Fan coil fan speed ON: 3-speed OFF: DC 0...10 V	
Control outputs #1 ON: On/Off OFF: DC 0...10 V	
Control outputs #2 ON: On/Off or 6-port valve DC invert OFF: DC 0...10 V or 6-port valve DC non-invert	
Scheduler ON: Enable OFF: Disable	

Icon	Description	Icon	Description
	Heating/cooling register		Cooling register
	Heating register		Electric heater
	Chilled/heated ceiling		Chilled ceiling
	Heat pump/compressor		Radiator

4.4.1 Applications for fan coil systems

Applications, DIP setting, control outputs					
<ul style="list-style-type: none"> 2-pipe fan coil unit <p>Using RDG2..KN, RDG2..T</p>		<ul style="list-style-type: none"> 2-pipe fan coil unit with electric heater <p>Using RDG2..KN, RDG2..T</p>		<ul style="list-style-type: none"> 2-pipe fan coil unit with radiator/floor heating <p>Using RDG2..KN, RDG2..T</p>	
<ul style="list-style-type: none"> 2-pipe/2-stage fan coil unit <p>Using RDG2..KN, RDG2..T</p>		<ul style="list-style-type: none"> 4-pipe fan coil unit <p>Using RDG2..KN, RDG2..T</p>		<ul style="list-style-type: none"> 4-pipe fan coil unit with electric heater <p>Using RDG2..KN, RDG2..T</p>	
<ul style="list-style-type: none"> 4-pipe fan coil unit with PICV and 6-port ball valve as changeover <p>Using RDG26..KN, RDG26..T</p>		<ul style="list-style-type: none"> 4-pipe/2-stage fan coil unit¹⁾ <p>Using RDG2..KN</p>		<ul style="list-style-type: none"> 4-pipe fan coil unit with 6-port PICV <p>Using RDG26..KN, RDG26..T</p>	
<ul style="list-style-type: none"> 4-pipe fan coil unit with 6-port ball valve <p>Using RDG26..KN, RDG26..T</p>		<p>YHC Heating/cooling valve actuator YH Heating valve actuator YC Cooling valve actuator YR Radiator</p> <p>YE Electric heater M1 1-speed or 3-speed fan, DC 0...10 V fan B1 Return air temperature sensor or external room temperature sensor (optional)</p> <p>B2 Changeover sensor (optional)</p> <p>¹⁾ 4-pipe/2-stage: Output can be set to 2-stage heating/1-stage cooling or 1-stage heating/2-stage cooling</p>			
Product No.	Control outputs	Fan output			
RDG20..	PWM, On/Off, 3-pos	3-speed, 1-speed, DC 0...10 V			
RDG26..	DC 0...10 V On/Off	3-speed, 1-speed, DC 0...10 V DC 0...10 V			

4.4.2 Applications for universal systems

Applications, DIP setting, control outputs		
<ul style="list-style-type: none"> Chilled/heated ceiling 	<ul style="list-style-type: none"> Chilled/heated ceiling and electric heater 	<ul style="list-style-type: none"> Chilled/heated ceiling and radiator/floor heating
<p>Using RDG2..KN, RDG2..T</p>	<p>Using RDG2..KN, RDG2..T</p>	<p>Using RDG2..KN, RDG2..T</p>
<ul style="list-style-type: none"> 2-stage chilled/heated ceiling 	<ul style="list-style-type: none"> Chilled ceiling and radiator 	<ul style="list-style-type: none"> Chilled and heated ceiling control with 6-port ball valve
<p>Using RDG2..KN, RDG2..T</p>	<p>Using RDG2..KN, RDG2..T</p>	<p>Using RDG26..KN, RDG26..T</p>
<ul style="list-style-type: none"> Chilled and heated ceiling control with PICV and 6-port ball valve as changeover 	<ul style="list-style-type: none"> 2-stage chilled and heated ceiling 	<ul style="list-style-type: none"> Chilled and heated ceiling control with 6-port PICV
<p>Using RDG26..KN, RDG26..T</p>	<p>Using RDG2..KN</p>	<p>Using RDG26..KN, RDG26..T</p>
<p>YHC Heating/cooling valve actuator YH Heating valve actuator YC Cooling valve actuator</p>	<p>YE Electric heater D3 Dewpoint sensor YR Radiator</p>	<p>B1 Return air temperature sensor or external room temperature sensor (optional) B2 Changeover sensor (optional)</p>
<p>Product No.</p>	<p>Control outputs</p>	
<p>RDG20..</p>	<p>On/Off, PWM, 3-position</p>	
<p>RDG26..</p>	<p>On/Off, DC 0... 10 V</p>	

4.4.3 Application for heat pump systems

Applications, DIP setting, control outputs			
<ul style="list-style-type: none"> Heated or cooled with compressors 		<ul style="list-style-type: none"> Heated or cooled with compressors with electric heater 	
<p>Using RDG2..KN, RDG2..T</p>	<p>Using RDG2..KN, RDG2..T</p>	<ul style="list-style-type: none"> Heated and cooled with compressors 	
<p>Using RDG2..KN, RDG2..T</p>	<p>Using RDG2..KN, RDG2..T</p>	<ul style="list-style-type: none"> 2-stage heated or cooled with compressors 	
<p>N1 Thermostat Output Y10/Q1: Heating or heating/cooling Output Y20/Q2: Cooling only (heating/cooling)</p>			<p>B1 Return air temperature sensor or external room temperature sensor (optional)</p>
<p>YE Electric heaters</p>			<p>D3 Dewpoint sensor</p>
Product No.	Control output	Fan	
RDG20..	On/Off, PWM, 3-position	Disabled, 1-speed, 3-speed, DC 0...10 V	
RDG26..	On/Off, DC 0...10 V	Disabled, DC 0...10 V	

4.4.4 Application with additional ventilation function

4.4.4.1 Cooling with air and IAQ in fan coil systems (RDG2..4KN)

Fresh air, controlled via damper, is used for reducing temperature in the room and CO₂ concentration. See Additional ventilation functions (IAQ + cooling with air) [→ 109].

Cold air can be provided in parallel when the fan coil in cooling mode is energized (in the 1st stage cooling) or as additional 2nd stage cooling sequence.



Applications, DIP setting, control outputs					
<ul style="list-style-type: none"> 2-pipe fan coil unit <p>Using RDG2..4KN</p>		<ul style="list-style-type: none"> 2-pipe fan coil unit with electric heater <p>Using RDG2..4KN</p>		<ul style="list-style-type: none"> 2-pipe fan coil unit with radiator/floor heating <p>Using RDG2..4KN</p>	
<ul style="list-style-type: none"> 4-pipe fan coil unit <p>Using RDG2..4KN</p>		<ul style="list-style-type: none"> 4-pipe fan coil unit with 6-port PICV <p>Using RDG2..4KN</p>		<ul style="list-style-type: none"> 4-pipe fan coil unit with 6-port ball valve <p>Using RDG2..4KN</p>	
<p>N1 Thermostat</p> <p>YHC Heating/cooling valve actuator</p> <p>YH Heating valve actuator</p> <p>YC Cooling valve actuator</p>	<p>YR Radiator</p> <p>YE Electric heater</p> <p>M1 1-speed or 3-speed fan, DC 0...10 V fan</p> <p>YV Variable air volume on terminal U1</p>	<p>B1 Return air temperature sensor or external room temperature sensor (optional)</p> <p>B2 Changeover sensor (optional)</p> <p>B3 CO₂ sensor</p>			

Product No.	Control outputs	Fan	Damper output U1
RDG204KN	PWM, 3-position	1-speed, 3-speed, DC 0...10 V	DC 0...10 V
RDG264KN	DC 0...10 V	1-speed, 3-speed, DC 0...10 V	DC 0...10 V

4.4.4.2 Cooling with air and IAQ in universal H/C systems (RDG2..4KN)

Fresh air, controlled via damper, is used for reducing temperature in the room and CO₂ concentration. See Additional ventilation functions (IAQ + cooling with air) [→ 109].

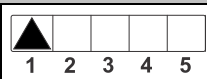
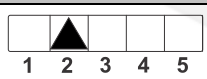
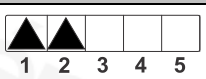
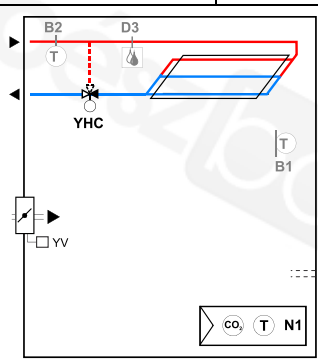
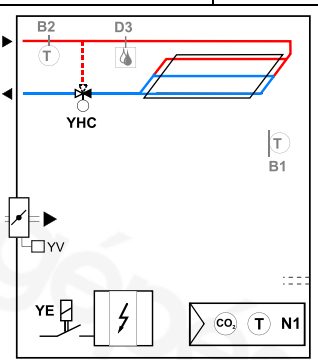
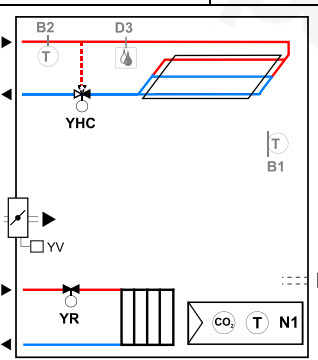

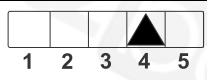
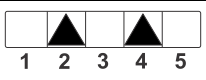
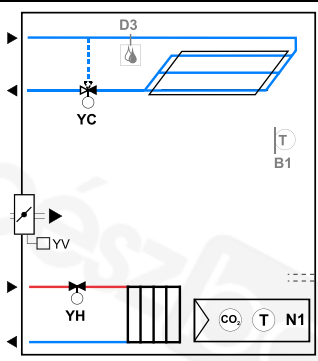
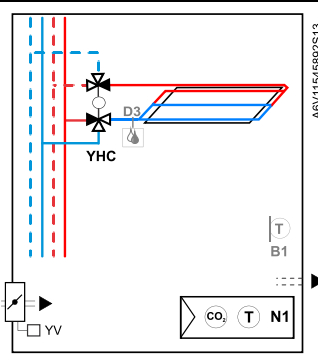
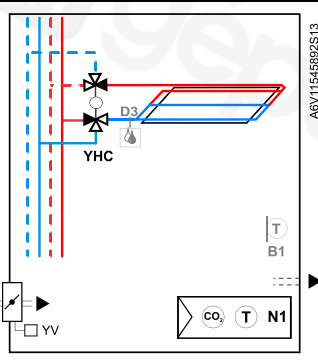
Cold air can be provided in parallel when the chilled ceiling is energized (in the 1st stage cooling) or as additional 2nd stage cooling sequence.

Applications, DIP setting, control outputs		
<ul style="list-style-type: none"> Chilled/heated ceiling 	<ul style="list-style-type: none"> Chilled/heated ceiling and electric heater 	<ul style="list-style-type: none"> Chilled/heated ceiling and radiator/floor heating 
 <p>Using RDG2..4KN</p>	 <p>Using RDG2..4KN</p>	 <p>Using RDG2..4KN</p>
<ul style="list-style-type: none"> Chilled ceiling and radiator 	<ul style="list-style-type: none"> Chilled and heated ceiling control with 6-port ball valve 	<ul style="list-style-type: none"> Chilled and heated ceiling control with 6-port PICV 
 <p>Using RDG2..4KN</p>	 <p>Using RDG2..4KN</p>	 <p>Using RDG2..4KN</p>
N1 Thermostat YHC Heating/cooling valve actuator YH Heating valve actuator	YC Cooling valve actuator YR Radiator YE Electric heater YV Variable air volume on terminal U1	B1 Return air temperature sensor or external room temperature sensor (optional) B2 Changeover sensor (optional) D3 Dewpoint sensor
Product No.	Control outputs	Damper output U1
RDG204KN	PWM, 3-position	DC 0...10 V
RDG264KN	DC 0...10 V	DC 0...10 V

4.4.4.3 Cooling with air in ventilation systems

With RDG2...4KN, fresh air, controlled via damper, is used for reducing temperature in the room and CO₂ concentration. See Cooling with air and IAQ control in ventilation systems [→ 114].

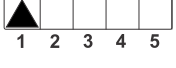
If only cooling with air is requested, without indoor air quality control, RDG260KN can be used with the setting described in Cooling with air and IAQ control in ventilation systems [→ 114].

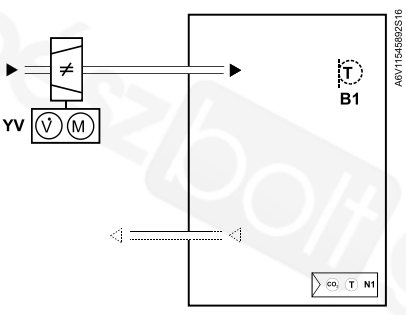
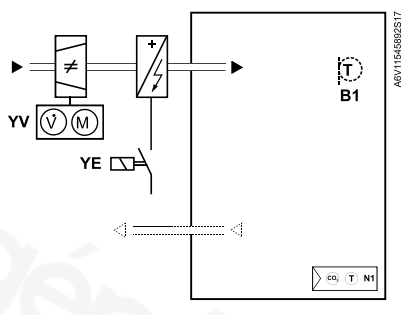
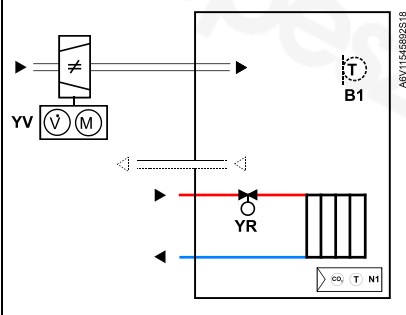
Applications, DIP setting, control outputs		
<ul style="list-style-type: none"> Single duct air cooling only 	<ul style="list-style-type: none"> Single duct air cooling only and electric heater 	<ul style="list-style-type: none"> Single duct air cooling only and radiator/floor heating 
 <p>Using RDG2..4KN, RDG260..</p>	 <p>Using RDG2..4KN, RDG260..</p>	 <p>Using RDG2..4KN, RDG260..</p>
YE Electric heater YR Radiator	YV Variable air volume on terminal U1	B1 Return air temperature sensor or external room temperature sensor (optional)
Product No.	Control outputs	Damper output U1/Y50 (YV)
RDG204KN..	PWM, 3-position	DC 0...10 V (U1 output)
RDG264KN..	DC 0...10 V	DC 0...10 V (U1 output)
RDG200..	On/Off, PWM, 3-position	DC 0...10 V (Y50 output)
RDG260..	DC 0...10 V, On/Off	DC 0...10 V (Y50 output)

4.5 Power supply selection for RDG20..KN

The RDG20..KN can be powered either on AC 230 V or AC 24 V.

The desired power supply is selected via the power switch on the rear of the device. The default setting is AC 230 V.

Therefore, RDG20..KN can be used with the following combinations:

- AC 230 V or AC 24 V systems with 3-speed and DC 0...10 V fan control
- SELV AC 24 V systems with PWM AC 24 V electrothermal actuators

⚠ Notes:

The outputs (triacs and relays) follow the main power supply, either AC 230 V or AC 24 V.

The device is damaged when set to AC 24 V but powered by AC 230 V.

To select the correct power supply, use the power switch on the rear of the device.

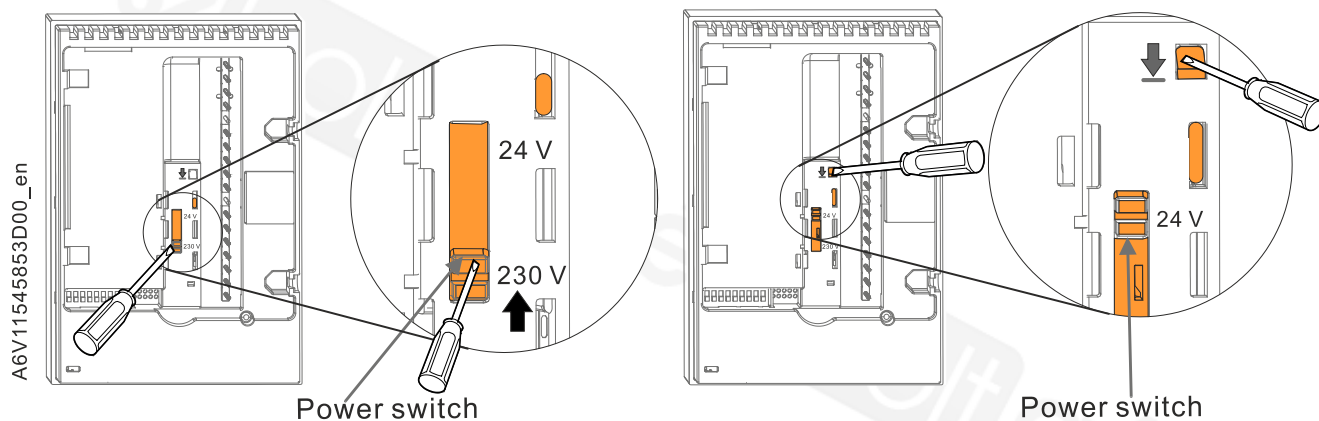

4.6 Additional functions

Functions (parameters)	Description	Standalone		RDG
		KNX		
Sensors and changeover functions [→ 54]				
<ul style="list-style-type: none"> Heating/cooling changeover via bus (KNX) 	Central control of heating / cooling via bus	✓		2..KN
<ul style="list-style-type: none"> Automatic heating/cooling changeover via changeover sensor Changeover switch (P150, P153, P155) 	Auto changeover on each equipment	✓	✓	2..
<ul style="list-style-type: none"> Manual heating/cooling changeover (P001) 	Heating / cooling controlled manually by user (via HMI)	✓	✓	2..
<ul style="list-style-type: none"> External/return air temperature sensor (P150, P153, P155) 	Temperature measurement with external sensors	✓	✓	2..
Presence detector [→ 56]				
<ul style="list-style-type: none"> Standard presence mode (P150 / P153 / P155) 	Switch operating mode locally or via bus	✓	✓	2..
<ul style="list-style-type: none"> Hotel presence mode (P150 / P153 / P155) 	Switch operating mode locally or via bus	✓	✓	2..
Output functions [→ 57]				
<ul style="list-style-type: none"> Purge function (P251) 	To ensure correct acquisition of the water temperature	✓	✓	2..
<ul style="list-style-type: none"> Minimum output On/Off time (P212, P213) 	To protect the HVAC equipment, for example, the compressor and reduce wear and tear	✓	✓	2..
<ul style="list-style-type: none"> Swap outputs for 2-pipe and 2-stage applications (P254) 	To optimize the use of heating/cooling energy in mixed systems	✓	✓	2..
<ul style="list-style-type: none"> Floor heating/cooling (P350) 	Application without fan control	✓	✓	2..
<ul style="list-style-type: none"> Qx relay switching function (P400, P401, P402) 	Control external equipment based on function status (Heating/cooling demand, operating mode, sequence, humidity, ...)	✓	✓	2..
Monitoring and limiting functions [→ 59]				
<ul style="list-style-type: none"> Floor temperature limitation function (P252) 	For user Comfort and protect the floor	✓	✓	2..
<ul style="list-style-type: none"> Supply air temperature limitation (P063, P064) 	To increase the comfort, by avoiding too warm or too cold air in the room	✓	✓	2..
<ul style="list-style-type: none"> Flow limitation in heating and cooling for PICV (P260, P261) 	To balance heating and cooling systems and avoid hydraulic problems caused by different flow rates	✓	✓	2..
<ul style="list-style-type: none"> Dewpoint monitoring Fault state "condensation" (P150, P153, P155 = 4) 	To prevent condensation damages in the building	✓	✓	2..
<ul style="list-style-type: none"> Valve kick/exercising (P250) 	To prevent valve freezing after extended inactivity	✓	✓	2..
<ul style="list-style-type: none"> Return flow temperature control (P061, P062) 	To save energy by adjusting flow speed in district heating systems	✓	✓	2..
User operation / Indication [→ 63]				
<ul style="list-style-type: none"> Button lock (P028) 	To limit access to unauthorized people	✓	✓	2..
<ul style="list-style-type: none"> Green leaf (P110, P111) 	Indication about energy efficient	✓		2..KN
<ul style="list-style-type: none"> Set time / date 	To set the time of day (AM/PM, hours and minutes) and date (weekday, month and year)	✓	✓	2..
<ul style="list-style-type: none"> Set Away (holiday mode) 	To set a holiday period	✓	✓	2..

Functions (parameters)	Description	Standalone		RDG
		KNX		
Humidity (RDG2..KN) [→ 65]				
<ul style="list-style-type: none"> Humidity control (P007, P450) 	Limit min. and max. humidity in the room	✓		2..KN
Scheduler [→ 69]				
<ul style="list-style-type: none"> Scheduler (P005) 	To set time schedule	✓	✓	2..
M/S, manager/subordinate (RDG2..KN) [→ 71]				
	To save energy in open spaces	✓		2..KN
Preventive operation [→ 74]				
<ul style="list-style-type: none"> Avoid cold air in heating mode (P365) 	To make sure reaching setpoint temperature during heating mode	✓	✓	2..
<ul style="list-style-type: none"> Avoid damage from moisture (P363, P364) 	To prevent from damage of moisture	✓	✓	2..
NFC communication [→ 75]				
<ul style="list-style-type: none"> NFC (P500) 	NFC communication via Siemens smartphone application	✓	✓	2..
IAQ - CO2 monitoring and control (RDG2..KN) [→ 75] (RDG204KN, RDG264KN)				
<ul style="list-style-type: none"> IAQ monitoring (P450) CO₂ indication (P009) IAQ control (P023, P450, P453, P454, P455, P456, P457, P458) Forced ventilation (P003) Frost protection (P109) IAQ control + air cooling (P023, P450, P457, P458) 	To monitoring and controlling indoor air quality	✓		2..4KN
Power reserve clock (RDG2..T) [→ 85]				
	Power reserve clock for 20 h during power failure		✓	2..T
Read live data via PCT Go [→ 185]				
	Service function for installers to check the correct installation, commissioning, and working conditions of the thermostats	✓	✓	2..

4.6.1 Sensors and changeover functions

Heating/cooling changeover via bus (KNX) (RDG2..KN)

The heating/cooling changeover information is received via bus. This is only possible if the control sequence is set to automatic heating/cooling changeover (P001 = 2) and no local input (X1, X2, U1) is assigned to this function.



Heating/cooling changeover

If required information is unavailable (e.g., due to data communication issues, power failure, etc.), the thermostat operates in the last valid room operating mode (heating or cooling).

Automatic heating/cooling changeover via changeover sensor

If a cable temperature sensor (LG-Ni1000 or NTC 3k) is connected to X1/X2/U1 (RDG2..KN)/X3 (RDG2..T), and P150/P153/P155 is set to 2, the water temperature acquired by the changeover sensor is used to change over from heating to cooling mode, or vice versa.

- When the water temperature is above 28 °C (adjustable via P060), the thermostat changes over to heating mode and remains in heating mode until the temperature drops below 16 °C (adjustable via P059).
- When the water temperature is below 16 °C (P059), the thermostat changes over to cooling mode and remains in cooling mode until the temperature exceeds 28 °C (P060).
- If the water temperature is between the 2 changeover points immediately after power-up (within hysteresis), the thermostat starts in the previous mode.

The water temperature is acquired and the operating state is updated accordingly.

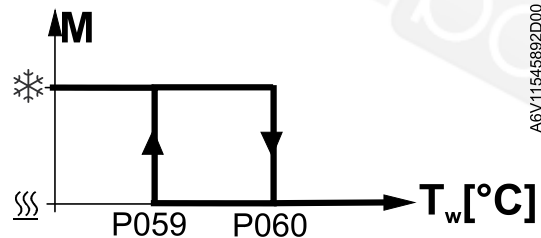

M Operating mode
 Tw Water temperature
 ❄ Cooling mode
 ~~~ Heating mode

**Note**

The setting range is 5 °C...P060-2 K for P059 and P059+2 K... 40 °C for P060.

**Changeover switch (P150, P153, P155)**

When P001 = 2 (H/C changeover auto) is selected, an NTC 3k or LG-Ni1000 cable temperature sensor for automatic heating/cooling changeover or one external switch for manual or remote changeover can be used to switch the equipment between heating and cooling:

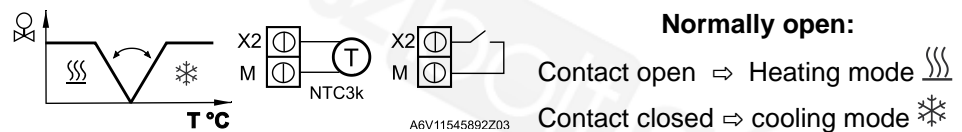

The sensor or switch can be connected to input terminal X2, X1 or U1 (RDG2..KN)/X3 (RDG2..T) based on the commissioning of the inputs (P150 (X1), P153 (X2), P155 (U1/X3) = 2).

See also Multifunctional input, digital input [→ 138].

**Note**

When using an external switch for changeover, the operating action is configured via P150, P153 or P155 = 2.

| P151 (X1), P154 (X2) or P156 (U1/X3) = 0 (default, normally open) | P151 (X1), P154 (X2) or P156 (U1/X3) = 1 (Normally close) |
|-------------------------------------------------------------------|-----------------------------------------------------------|
| Contact open => heating mode ~~~                                  | Contact open => cooling mode ❄                            |
| Contact closed => cooling mode ❄                                  | Contact closed => heating mode ~~~                        |

**Manual heating/cooling changeover (P001)**

- Manual heating/cooling changeover means selection via changeover button on the thermostat by repeatedly pushing the button until the required mode is displayed.
- If manual heating/cooling changeover is commissioned (P001 = 3), heating/cooling mode cannot be changed via bus/changeover sensor/switch; it remains in the last mode selected locally via button.

**External/return air temperature sensor (P150, P153, P155)**

The thermostat acquires the room temperature via built-in sensor, external room temperature sensor (QAA32), or external return air temperature sensor (NTC 3k or LG-Ni1000) connected to multifunctional input X1, X2 or U1/X3.

Inputs X1, X2 or U1/X3 must be commissioned accordingly. See Multifunctional input, digital input [→ 138].

## 4.6.2 Presence detector

The operating mode can be changed to Comfort or Economy mode based on room occupancy (room occupied or unoccupied, via presence detector or keycard).

### Standard presence mode (Input: P150 / P153 / P155 = 10)

The presence detector input switches the operating mode to Comfort when the room is occupied and switches back to the previous operating mode when the room is unoccupied.



Presence detection is also possible via bus (RDG2..KN). In this case, do not assign the function to any local input X1, X2 or U1.

| Time schedule via bus (RDG2..KN) | Presence detector behavior                                                                                                                                                                                                                   |
|----------------------------------|----------------------------------------------------------------------------------------------------------------------------------------------------------------------------------------------------------------------------------------------|
| Comfort mode                     | When the presence detector is activated or deactivated, the operating mode remains in Comfort.                                                                                                                                               |
| Economy mode                     | <ul style="list-style-type: none"> <li>When the presence detector is activated, the operating mode changes to Comfort.</li> <li>When the presence detector is deactivated, the operating mode changes to Economy (Auto).</li> </ul>          |
| Protection mode                  | Presence detection has no influence on the operating mode.                                                                                                                                                                                   |
| Not available                    | <ul style="list-style-type: none"> <li>When the presence detector is activated, the operating mode changes to Comfort.</li> <li>When the presence detector is deactivated, the operating mode changes to previous operating mode.</li> </ul> |

### Hotel presence mode (Input: P150 / P153 / P155 = 13)

If a room is unoccupied, the operating mode changes to Economy. This overrides the operating mode on the thermostat. The buttons are locked and symbol  is displayed. An occupied room sets the thermostat back to the previous operating mode. Use a card reader and not a motion detector combined with hotel presence function for hotel applications, as the buttons are locked in case of unoccupancy.

Hotel presence detection is also possible via bus (RDG2..KN). In this case, do not assign the function to local input X1, X2 or U1.

| Time schedule via Bus (RDG2..KN) | Presence detector behavior                                                                                                                                                                                                                                                                                                                                                              |
|----------------------------------|-----------------------------------------------------------------------------------------------------------------------------------------------------------------------------------------------------------------------------------------------------------------------------------------------------------------------------------------------------------------------------------------|
| Comfort mode                     | When hotel guests leave their rooms (room is unoccupied), the operating mode changes to Economy. The buttons are locked and symbol  is displayed.                                                                                                                                                  |
| Economy mode                     | <ul style="list-style-type: none"> <li>When hotel guests leave their rooms (room is unoccupied), the operating mode changes to Economy. The buttons are locked and symbol  is displayed.</li> <li>When the room is occupied, the operating mode changes to the previous operating mode.</li> </ul> |
| Protection mode                  | Presence detection has no influence on the operating mode.                                                                                                                                                                                                                                                                                                                              |
| Not available                    | <ul style="list-style-type: none"> <li>When hotel guests leave their rooms (room is unoccupied), the operating mode changes to Economy. The buttons are locked and symbol  is displayed.</li> <li>When a room is occupied, the operating mode changes to the previous operating mode.</li> </ul>   |



Notes

- When the schedule changes to Economy but the presence detector is still active, the operating mode remains in Comfort mode until the presence detector becomes inactive.
- The contact (e.g., a card reader) can be connected to multifunctional input X1, X2 or U1 (set P150, P153 or P155 to 10) or occupancy is sent via bus from a KNX presence detector (only one input source must be used, either local input X1/X2/U1 or KNX bus).

### 4.6.3 Output functions

**Purge function (P251)**

The changeover sensor ensures changeover between heating and cooling mode based on the acquired water temperature. We recommend activating the Purge function (P251) with 2-port valves. This function ensures correct acquisition of the medium temperature even if the 2-port valve is closed for an extended period of time. The valve is opened for 1 to 5 minutes (adjustable) at 2-hour intervals during off hours.

The function is valid for outputs PWM, On/Off, On/Off 3-wire, DC, 3-position and all 2-pipe applications.

**Minimum output On/Off time (P212, P213)**

Limit the On/Off switching cycle to protect HVAC equipment, e.g., compressor and reduce wear and tear. The minimum output on-time and off-time for the On/Off control output can be adjusted from 1 to 20 minutes via P212 and P213. The factory setting is 1 minute.

Readjusting the setpoint or heating/cooling mode changeover immediately results in calculation of the output state; the outputs may not hold the minimum 1-minute On/Off time.

If P212 or P213 is set to greater than 1 minute, the minimum On/Off time for the control output is maintained as set, even if the setpoint or changeover mode is readjusted.

**Swap outputs for 2-pipe and 2-stage applications (P254)**

For 2-pipe and 2-stage applications with different equipment, e.g., fan coil units and radiant heating/cooling panels, it is possible to invert the sequence of the equipment to optimize energy use, when the thermostat changes the sequence from heating to cooling (P001 = 2 or 3).

Under factory settings, the 1<sup>st</sup> stage in heating (YHC1) is also the 1<sup>st</sup> stage in cooling.

The swap function optimizes use of heating/cooling energy in mixed systems. E.g., when the fan coil units are combined with radiant heating/cooling panels, it is better to start heating using the panels (1<sup>st</sup> stage heating, YHC1) and start cooling using the fan coil unit (1<sup>st</sup> stage cooling, YHC2).

Enable the swap function by setting P254 (YHC2 output signal, 1<sup>st</sup> stage in cooling) to ON, depending on the requested control signal.

Swap function disabled

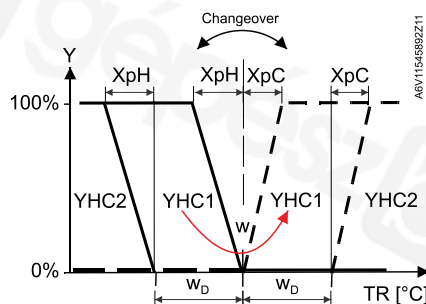

P254 is set to Off

Swap function enabled

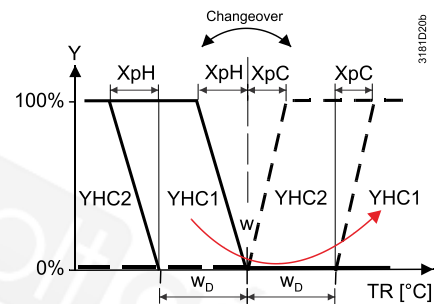

P254 is set to On

**Note**

- For 2-pipe/2-stage applications, see 2-stage on 2-pipe/4-pipe heating and cooling [→ 95].
- If the equipment requests fan operation only in the 2<sup>nd</sup> stage (heating and/or cooling), see Fan control [→ 131] to set up the fan function (fan in the 2<sup>nd</sup> stage).
- For application examples, see Swap function and/or fan in the 2nd stage [→ 198].

**Floor heating/Floor cooling (P350)**

All heating sequences can also be used for floor heating.

You can use fan coil unit heating/cooling sequences for floor heating or cooling by disabling the fan via P350.

**Qx relay switching function (P400, P401, P402)**

The following functions allow the control of external equipment connected to the Q1, Q2 and Q3 relay outputs:

| Function description                                                                                                                                                     | P40X =      |
|--------------------------------------------------------------------------------------------------------------------------------------------------------------------------|-------------|
| No function                                                                                                                                                              | 0           |
| Switching off external equipment when the thermostat is in Protection mode                                                                                               | 1           |
| Switching on external equipment during... <ul style="list-style-type: none"> <li>• heating/cooling demand</li> <li>• heating demand</li> <li>• cooling demand</li> </ul> | 2<br>3<br>4 |
| Energizing the contact when... <ul style="list-style-type: none"> <li>• the heating sequence is active</li> <li>• the cooling sequence is active</li> </ul>              | 5<br>6      |
| Humidity control: <ul style="list-style-type: none"> <li>• Output to control dehumidifier</li> <li>• Output to control humidifier</li> </ul>                             | 7<br>8      |

**Note**

- When P351 = 1 and 2, these functions are not available.
- When fan is DC 0...10 V fan (P351 = 3) or fan is disabled (P350 = 0) and related relays are not occupied by output (configure 1 stage or 2 stage as On/Off on RDG26..KN), these functions are available.
- Do not use these functions in combination with On/Off valve control (P201/P203 = 2 / 4 or P204/P205 = 4) to ensure temperature control accuracy. If these functions are required, the total maximum current on the relay outputs (Q1+Q2+Q3) must not exceed 2 A.

The relay output function can be enabled and tested as follows:

| Relay output function on ... | Enable function via Expert level parameter | Test function via diagnostic parameter |
|------------------------------|--------------------------------------------|----------------------------------------|
| Q1                           | P400                                       | d08                                    |
| Q2                           | P401                                       | d09                                    |
| Q3                           | P402                                       | d10                                    |

**Switching off external equipment in Protection mode**

The external equipment (e.g., fan coil unit) can be switched off via relay output to save energy when the thermostat is in Protection mode and no temperature control is requested.

Set the related output parameter to 1 to enable the function.

Relay contact is open when the thermostat is in Protection mode.



**NOTICE!** The relay contact does not switch on when the room temperature is below the frost protection setpoint.

For application examples, see Relay functions [→ 196].

#### Energizing the contact during heating/cooling demand

During heating or cooling demand, the relay contact can be energized to control external equipment, e.g., to run the pump for a water system (fan coil unit) or a compressor.

To reduce wear and tear on HVAC equipment, the minimum output On/Off time of the Qx relay output can be adjusted (1...20 minutes) via P212 and P213. The factory setting is 1 minute.

To enable the function, set the related output parameter:

- To energize the output during heating/cooling demand, set the parameter to 2.
- To energize the output during heating demand, set the parameter to 3.
- To energize the output during cooling demand, set the parameter to 4.

For application examples, see Relay functions [→ 196].

#### Notes

- During heating demand, the relay contact remains Off only with electric heater or radiator (output signal on Y2/Y20 > 0 V).
- If the purge function (P251) is active (1...5 minutes every 2 hours), the relay contact turns on to run the external equipment, e.g., a water pump.

#### Output heating/cooling sequence

This function switches the relay output on or off depending on the sequence, either heating or cooling. The output can be used to release a heat pump compressor, a reversing valve or 6-port ball valve as changeover.

To enable the function, set the related output parameter:

- To close the contact when the thermostat is in heating mode (even in the dead zone), set the parameter to 5.
- To close the contact when the thermostat is in cooling mode (even in the dead zone), set the parameter to 6.

For application examples, see Relay functions [→ 196].

To reduce wear and tear on HVAC equipment, the minimum output On/Off time of the Qx relay output can be adjusted (1...20 minutes) via P212 and P213. The factory setting is 1 minute.

#### Humidity control

Depending on room humidity and the humidity setpoint, the humidity control function switches the relay outputs to control the external equipment, e.g., dehumidifier/humidifier. See Humidity control [→ 193].

To enable the function, set the related output parameter:

- To control the dehumidifier, set the parameter to 7
- To control the humidifier, set the parameter to 8

To reduce wear and tear on the HVAC equipment, the minimum output On/Off time of the Qx relay output can be adjusted (1...20 minutes) via P212 and P213. The factory setting is 1 minute.

#### Note

When the operating mode is changed from Comfort to Protection, the relay contact remains energized until the end of the minimum on time set via P212.

## 4.6.4 Monitoring and limiting functions

#### Floor temperature limitation function (P252)

The floor temperature should be limited for two reasons: Comfort and protection of the floor.

The floor temperature sensor, connected to multifunctional input X1, X2 or U1 (RDG2..KN)/X3 (RDG2..T), acquires the floor temperature. If the temperature exceeds the parameterized limit (P252), the heating valve is fully closed until the floor temperature drops to a level 2 K below the parameterized limit. The factory setting of P252 is 28 °C.

Input X1, X2 or U1/X3 must be commissioned accordingly (P150, P153, P155 = 11) and the type of sensor need to be selected (P151, P154, P156 = 2 (NTC 3K) or 3 (LG-Ni1000)).

See Multifunctional input, digital input [→ 138].

#### Recommended values for P252

- Living rooms:  
Up to 26 °C for extended presence, up to 28 °C for short presence.
- Bathrooms:  
Up to 28 °C for extended presence, up to 30 °C for short presence.

The "Floor temperature limitation" function influences the outputs listed in the table below:

| Application                 | Output Y1/Y10       | Output Y2/Y20       | Output Y3/Y30     | Output Y4/U1      | "Floor temp.limit" function has impact on |                      |                                | Remark               |
|-----------------------------|---------------------|---------------------|-------------------|-------------------|-------------------------------------------|----------------------|--------------------------------|----------------------|
|                             |                     |                     |                   |                   | Heating (P001 = 0/2/3)                    | Cooling P001 = 1/2/3 | Heating and Cooling (P001 = 4) |                      |
| 2-pipe                      | H/C valve           | -                   | -                 | -                 | Y1/Y10                                    | N/A                  | -                              | -                    |
| 2-pipe with electric heater | H/C valve           | Electric heater     | -                 | -                 | Y2/Y20                                    | Y2/Y20 *)            | -                              | Only electric heater |
| 2-pipe with radiator        | H/C valve           | Radiator            | -                 | -                 | Y2/Y20                                    | Y2/Y20               | -                              | Only radiator        |
| 4-pipe                      | Heating valve       | Cooling valve       | -                 | -                 | Y1/Y10                                    | N/A                  | Y1/Y10                         | -                    |
| 4-pipe with electric heater | Heating valve       | Cooling valve       | Electric heater   | -                 | Y3/Y30                                    | N/A                  | Y3/Y30                         | Only electric heater |
| 2-pipe/2-stage              | 1 <sup>st</sup> H/C | 2 <sup>nd</sup> H/C | -                 | -                 | Y1/Y10, Y2/Y20                            | N/A                  | -                              | -                    |
| 4-pipe/2-stage (RDG2..KN)   | 1 <sup>st</sup> H   | 1 <sup>st</sup> C   | 2 <sup>nd</sup> H | 2 <sup>nd</sup> C | Y1/Y10, Y3/Y30                            | N/A                  | Y1/Y10, Y3/Y30                 | -                    |

\*) If P027 = ON, electric heater in cooling mode.

#### Note

Either floor temperature sensor or external room temperature sensor can be used.

#### Supply air temperature limitation (P063, P064)

This function increases the comfort in the room by keeping the supply air temperature of the fan coil unit between the selected minimum and maximum temperature limits.

If the supply air temperature exceeds a limit, the thermostat reduces the corresponding valve position until the supply air temperature is back in the limits.

In case the air flow is too low (especially with DC 0...10 V fans), this prevents cold air from dumping into the room/warm air from bubbling straight up instead of circulating.

To enable this function, the multifunctional input, to which the supply air sensor is connected, needs to be set to "Supply air sensor" (e.g., P150 = 9). Then the parameters for the limits are displayed (P063: minimum supply air temperature, P064: maximum supply air temperature).

#### Note

- This function is only active in Comfort mode when:
  - Valve output type is 3-position (RDG20..) or DC 0...10 V (RDG26..)
  - Electric heater is PWM / 3-position (RDG20..) or DC 0...10 V (RDG26..)
- This function can not be used for radiators.
- This function can not be used in 4-pipe with 6-port ball valve application.

#### Flow limitation function for combi valve (PICV); P260 & P261, RDG26..)

Set different limits to the flow in both sequences, heating and cooling to balance heating and cooling systems and avoid hydraulic problems caused by the different flow rates.

Cooling typically requires a higher flow rate than heating, and generally the combi valve (PICV) is mechanically and manually set to the cooling flow limit.

However, when the system operates in heating mode, another flow limitation is requested.

Tools can independently adjust the new maximal water flow limits for heating and cooling (new valve positions, by 100 % heating and cooling demand), by limiting DC 0...10 V signals via parameters P260 (heating) and P261 (cooling).

The adjusted parameters can be easily downloaded to thermostats using the smartphone app PCT go with the NFC technology. This avoids complex procedures for mechanically adjusting the limits, i.e. directly on the valves.



**PICV cooling/heating maximal position (P260, P261)**

PICV maximum position for cooling and heating can be set via KNX S-Mode objects 104, 105.

The function can be enabled on all combined heating/cooling applications with DC 0...10 V output for universal and fan coil unit applications.

For applications with 6-port PICV, the maximal water flow limitation can be set directly in liters per hours (l/h) via smartphone APP, based on the installed diameter nominal (DN) of the valve.

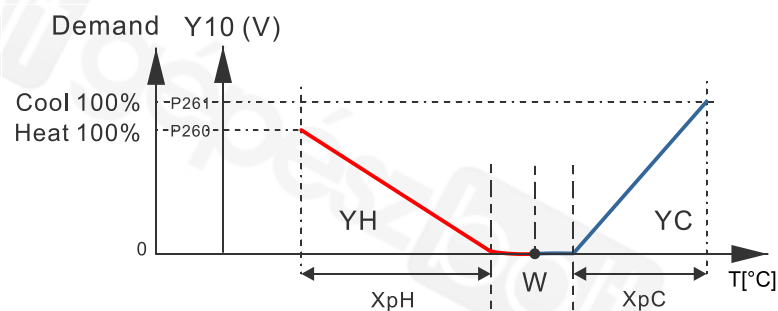

|       |                           |    |                                   |
|-------|---------------------------|----|-----------------------------------|
| T[°C] | Room temperature          | YH | Control command "Valve" (heating) |
| Y10   | DC 0...10 V signal        | YC | Control command "Valve" (cooling) |
| W     | Room temperature setpoint |    |                                   |

The function can be enabled for all heating/cooling applications with DC 0...10 V output.

**Note**

RDG264KN with older software version V3.1.6 and lower versions and RDG260KN with older software version V2.2.0 and lower versions use parameter P256 to adjust max flow limitation on the PICV for heating. Limiting the water flow for cooling is not available.

**Dewpoint monitoring**

Dewpoint monitoring is essential to prevent condensation on the chilled ceiling (cooling with fan disabled, P350 = 0) and associated damages to the building.

A dewpoint sensor with a potential-free contact is connected to multifunctional input X1, X2 or U1 (RDG2..KN)/X3 (RDG2..T). If there is condensation, the cooling valve is fully closed until no more condensation is detected, and the cooling output is disabled temporarily.

If the fan function is enabled (P350 ≠ 0), the fan continues to work as long as the dewpoint function is active.

**Note**

When condensation is detected with

- Control only with 6-port control ball valve:
  - If P201 = 6 or 8, the valve closes (5 V).
  - If P201 = 7 or 9, the valve closes (6 V).
- Control with combi-valve (PICV): The PICV closes and the 6-port ball valve remains open.

**Fault state**

"condensation" (P150 / P153 / P155 = 4)

**Fault information**

The condensation symbol  is displayed during temporary override and fault "Condensation in room" is sent via bus.

The input must be commissioned accordingly (P150, P153 and P155).

See Multifunctional input, digital input [→ 138].

**Valve kick/exercising (P250)**

To prevent valve freezing after extended inactivity (e.g. cooling valves in winter), valves need to be activated periodically. To save energy, the valve kick/exercising function is triggered when valves are closed for 91 hours. The valves are then activated for 2 minutes. This function can be enabled via P250.

**Delta temperature control**

For district heating systems (2-pipe systems), this function is used to increase the system efficiency. It guarantees that the delta temperature between flow and return temperature for water does not drop below the defined setpoint selected by P061 for cooling and P062 for heating.

As a result, the water flow and speed are reduced with a consequent reduction of noise and energy consumption.

It is important that the delta temperature control function only releases the valve position in small steps for avoiding risk of oscillating control loops resulting in life expectancy issues. This means that when delta temperature drops below the defined setpoint, the time duration to align the new valve position is 30min. In the same way, the valves need 30min to reach the original control position, when the delta temperature exceeds the defined setpoint.

**Note**

- When the multifunctional input P150, P153 or P155 is set to 14 (Coil return temperature), the parameters P061 (Setpoint  $\Delta T$  cooling) and P062 (Setpoint  $\Delta T$  heating) are visible.
- Set P061 or P062 or both to the requested value to activate the return flow temperature control function

**Setting**

Applications with flow and return temperature sensors, the sensors are wired directly to the thermostat:

|          | Function                                      | Multifunctional inputs P150, P153, P155 |
|----------|-----------------------------------------------|-----------------------------------------|
| Sensor 1 | Flow temperature <sup>1)</sup>                | = 12 (Coil flow temperature)            |
|          | Flow temperature and changeover <sup>2)</sup> | = 2 (H/C changeover)                    |
| Sensor 2 | Return temperature                            | = 14 (Coil return temperature)          |

<sup>1)</sup> (P15x = 12) If the flow temperature value is provided via KNX, the corresponding multifunctional input setting (= 12) must be removed. (RDG2..KN)

<sup>2)</sup> (P15x = 2) The sensor temperature value is used for the changeover function and flow temperature. If the thermostat receives the flow temperature value from the bus, the thermostat works according to the flow value provided via bus (bus has higher priority). (RDG2..KN)

To receive the flow temperature via bus from a Synco device, set the same value for distribution zone heating / colling (P903...P905) of the Synco device and thermostats. (RDG2..KN)

**Note**

For an accurate delta temperature control performance, we recommended using the same cable type and length for both flow and return sensors.

## 4.6.5 User operation / Indication

### Note





When the thermostat is set as subordinate (P258 = 0), P005 (scheduler), P028 (keypad), P110 (energy indicator) and P111 (energy indicator range) are invisible and the subordinate synchronizes the related operation with its manager. (RDG2..KN)

### Button lock (P028)

If the "Button lock" function is enabled by P028, lock or unlock them by pressing the right button for 3 seconds.

If "Auto lock" is configured, the thermostat automatically locks the buttons 10 seconds after the last adjustment.

P028 can be configured as following:

| P028 |                                                     |  |  |  |  |
|------|-----------------------------------------------------|------------------------------------------------------------------------------------|-------------------------------------------------------------------------------------|-------------------------------------------------------------------------------------|-------------------------------------------------------------------------------------|
| 0    | Unlocked                                            |                                                                                    |                                                                                     |                                                                                     |                                                                                     |
| 1    | Auto lock                                           | locked                                                                             | locked                                                                              | locked                                                                              | locked                                                                              |
| 2    | Manual lock                                         | locked                                                                             | locked                                                                              | locked                                                                              | locked                                                                              |
| 3    | Auto lock operating mode                            | locked                                                                             |                                                                                     |                                                                                     |                                                                                     |
| 4    | Auto lock setpoint shift                            |                                                                                    |                                                                                     |                                                                                     | locked                                                                              |
| 5    | Auto lock fan speed                                 |                                                                                    |                                                                                     | locked                                                                              |                                                                                     |
| 6    | Auto lock operating mode, setpoint shift            | locked                                                                             |                                                                                     |                                                                                     | locked                                                                              |
| 7    | Auto lock operating mode, fan speed                 | locked                                                                             |                                                                                     | locked                                                                              |                                                                                     |
| 8    | Auto lock fan speed, setpoint shift                 |                                                                                    |                                                                                     | locked                                                                              | locked                                                                              |
| 9    | Auto lock scheduler                                 |                                                                                    | locked                                                                              |                                                                                     |                                                                                     |
| 10   | Auto lock operating mode, scheduler                 | locked                                                                             | locked                                                                              |                                                                                     |                                                                                     |
| 11   | Auto lock scheduler, fan speed                      |                                                                                    | locked                                                                              | locked                                                                              |                                                                                     |
| 12   | Auto lock operating mode, scheduler, fan speed      | locked                                                                             | locked                                                                              | locked                                                                              |                                                                                     |
| 13   | Auto lock scheduler, setpoint shift                 |                                                                                    | locked                                                                              |                                                                                     | locked                                                                              |
| 14   | Auto lock operating mode, scheduler, setpoint shift | locked                                                                             | locked                                                                              |                                                                                     | locked                                                                              |
| 15   | Auto lock scheduler, fan speed, setpoint shift      |                                                                                    | locked                                                                              | locked                                                                              | locked                                                                              |

When P028 is set to 3...15, the related function is locked and the corresponding symbol cannot be displayed.

### Green leaf indication (P110, P111) (RDG2..KN)

Green leaf indication (green or red leaf) informs users if equipment operates within the energy-efficient setting range (leaf is green).

When the setting exceeds the preset energy efficiency range, the leaf color changes to red. End users can press the red leaf to return to the energy efficiency.

The functions are defined as follows:

- Green leaf: Settings are within the preset energy-efficiency range:
  - The setpoint range is defined by the Comfort basic setpoint (P011) plus/minus the energy indicator range (P111). It applies only to the Comfort setpoint concept (P010 = 1)

- Fan speed: The manual fan is below or equal to the auto fan speed value
  - Operating mode: The manual mode is lower or equal to the scheduler mode
  - Red leaf: The settings exceed the preset energy-efficiency range
- P110 configures the green leaf function:
- 0 = Disabled (OFF)
  - 1 = Green and red dimmed down
  - 2 = Green dimmed down / red fixed
  - 3 = Green and red fixed

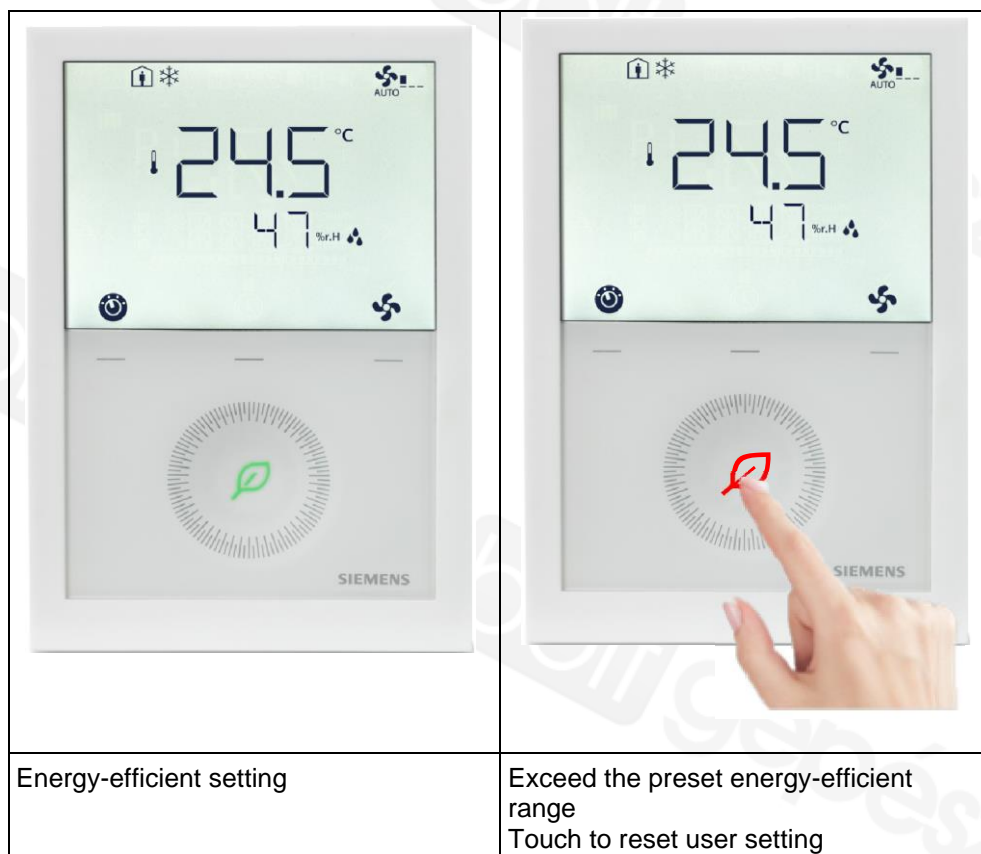







## Set Time / date

## Set TIME

|                                                                                     |                                                                                                                                                                                                                                                                           |
|-------------------------------------------------------------------------------------|---------------------------------------------------------------------------------------------------------------------------------------------------------------------------------------------------------------------------------------------------------------------------|
| <b>⚠ WARNING</b>                                                                    |                                                                                                                                                                                                                                                                           |
|  | <p><b>Time synchronization via bus (RDG2..KN)</b></p> <p>Time of day and date information are received from a Synco controller with time manager function (RMB, OWZ, etc) or any other KNX device e.g. GPS clock, if the corresponding communication object is bound.</p> |

The scheduler function must be enabled before setting the time of day:

- Press  once and then turn the rotary knob or press  continuously to select programming mode TIME.
- Press  once and then turn the rotary knob to select the time format.
- If 12H is selected, press  once and then turn the rotary knob to select AM or PM.
- Press  once and enter the hour setting.
- The hour value flashes and can be changed by turning the rotary knob.
- Press  once to confirm the adjusted value and enter the minutes setting.









Repeat the steps as for the hour.

**Note**

- AM/PM does not display when set to 24 hour clock.
- Power reserve clock for 20 h during power failure (RDG2..T)

**Set DATE**

The scheduler function must be enabled before setting the date:

- Press  once and then turn the rotary knob or press  continuously to select programming mode DATE.
- Press  once to enter the date setting.
- Turn the rotary knob to select month / weekday / year, then press  once.
- For example, enter the year setting. The Year value flashes and can be changed by turning the rotary knob.
- Press  once to confirm the adjusted value, or  (Esc) to cancel the change.

Repeat steps for month and weekday settings.

**Note**









Power reserve clock for 20 h during power failure (RDG2..T)

**Set Away (Holiday mode)**

**Set AWAY (Holiday mode)**

The holiday start time (date and month) can be set after entering holiday mode.

The scheduler function must be enabled before setting the holiday period:

- Press  once and then turn the rotary knob or press  continuously to select programming mode AWAY. Holiday mode  is displayed once the start time arrives.
- Press  once to enter scheduler mode .
- Turn the rotary knob to adjust the number of days (holidays), then press  once.
- Set the start time (AWAY): Set the month (MON) and then press  ⇒ Set the day (DAY)
- Press  once to confirm the adjusted value; the idle page for Holiday mode is displayed.

**Note**

- Holiday mode only can be set via local HMI.
- Only the local HMI or window contact/presence detector can stop holiday mode. Intervention from the bus cannot change the mode. Holiday mode remains active until the next intervention from a local HMI or window contact/presence detector is received.
- The set holiday mode is deleted once the holiday period ends; user must set a new one for the next year as needed.

**4.6.6 Humidity (RDG2..KN)**

**Humidity control (P007, P450)**

Humidity control limits humidity in the room according to the selected setpoint (low/high) by shifting the temperature setpoint, or by enabling outputs to release the external equipment as needed, e.g., the dehumidifier or humidifier.

Humidity control is active in Comfort and Economy mode when P450 is set to 1. The function can be disabled by setting P450 to 0 (factory setting).

Humidity function is disabled in Protection mode.

The humidity level in the room is acquired by the built-in sensor. The thermostat can receive the relative humidity via the bus if a valid humidity value is available and selected on KNX (S-Mode or LTE-Mode).



The priorities are set as follows:

1. S-Mode
  - By setting parameter "Room relative humidity" in the ETS to **Receive**, the thermostat can display the relative humidity measured by an external sensor on the bus.
  - If the parameter is set to **Send** (factory setting), the thermostat can display the humidity value measured by the built-in sensor and the value is sent to the bus.
2. LTE-Mode
 

The thermostat displays the relative humidity value on the bus if the external KNX sensor is in the same geographic zone apartment and room (A.R.1) as the thermostat.
3. In other cases, the thermostat displays the humidity value measured by the built-in sensor.

#### Note

#### Setpoint (P024, P025, P026)

To display room humidity (%) on the thermostat, P009 needs to be set to 5.

The high humidity setpoint (%) is selected via P024 or P025 (setpoint humidity high Comfort and Economy) and can be adjusted via parameters in Service level or via bus.

Setting P024 or P025 to Off disables high humidity control.



The low humidity setpoint (%) is selectable via P026 (setpoint humidity low) and can be adjusted via parameters in Service level or via bus.

Setting P026 to OFF (default setting) disables low humidity control. The setting range is limited by P024.

S-Mode objects for the humidity setpoint are available, if the parameter "Humidity setpoints" is set to **as group object** in ETS.

#### Dehumidification

When relative humidity exceeds the high setpoint, the thermostat shifts the temperature setpoint proportionally until P461 (max. shift temp setpoint) is reached. If this control does not sufficiently reduce humidity, an external dehumidifier can be switched on via relay outputs or KNX and related relay function (P400, P401 or P402 is set to 7).

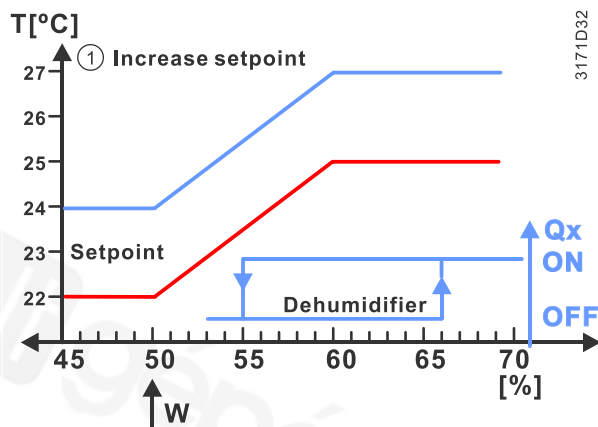

#### Note

The maximum temperature shift setpoint value is reached at setpoint humidity high (P024) +10%. The contact for the dehumidifier is released at setpoint humidity +15%.

#### Dehumidification

Applications with a DC 0...10 V fan:

- Enable the function to control the external dehumidifier directly via relay output by setting P400 (output Q1), P401 (output Q2) or P402 (output Q3) to 7. When the output is energized, S-Mode object dehumidification sends the information "ON" to the bus
- The selected relay output is switched on if relative humidity exceeds the high setpoint by +15%.

- For applications with On/Off valves on Q1 or Q2 or both, the output Q3 (P402 = 7) is used to control the external dehumidifier.
- The relay contact remains closed or open for the minimum On/Off time defined by P212 or P213.

Applications with a 3-speed fan:

- The external dehumidifier is controlled via external DC – On/Off converter connected to analog output Y50. The output signal is DC 10 V if dehumidification control is requested.
- Output Y50 remains On for min. 30 seconds (not selectable).
- This function is available without specific settings (P400, P401 and P402 are not displayed).

**Note**

The current of the external DC – On/Off converter cannot exceed the maximum output current of Y50 (max. 5 mA). We recommend using the converter from Titan (single relay control (IO/1RM) at 3 mA input current).

**Humidification**

The function controls minimum relative humidity in the room and is available only for applications with DC 0...10 V fan or no fan.

The external humidifier connected to the relay output is enabled as soon as humidity drops below setpoint humidity low (P026) at hysteresis is  $\pm 5\%$ .

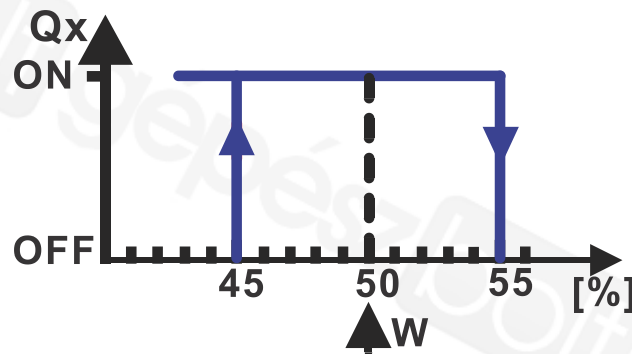

To enable the relay function, set P400 (output Q1), P401 (output Q2) or P402 (output Q3) to 8. The humidification S-Mode object sends On to the bus as soon as the output is energized.

When humidity drops below the low setpoint or exceeds the high setpoint, symbol  $\text{---}\blacklozenge$  is displayed and S-Mode object HumDehumMode sends the corresponding state on the bus.



**Max. shift temperature setpoint (P461)**

When humidity reaches setpoint humidity high (Comfort: P024, Economy: P025), the thermostat shifts the temperature setpoint to reduce relative humidity in the room.

The maximum shifting temperature setpoint can be set via P461 at Expert level at a setting range of -3...3 K, depending on the connected equipment. The factory setting is 3 K.

The maximum shifting temperature setpoint value is reached at setpoint humidity high (P024, P025) +10%.

**P461 > 0 K**

The positive values of P461 (0.5...3.0 K) are used for heating and cooling, or heating in a humid cold environment.

For heating and cooling, both temperature setpoints (heating and cooling) are shifted in parallel (i.e., dead zone remains unchanged).

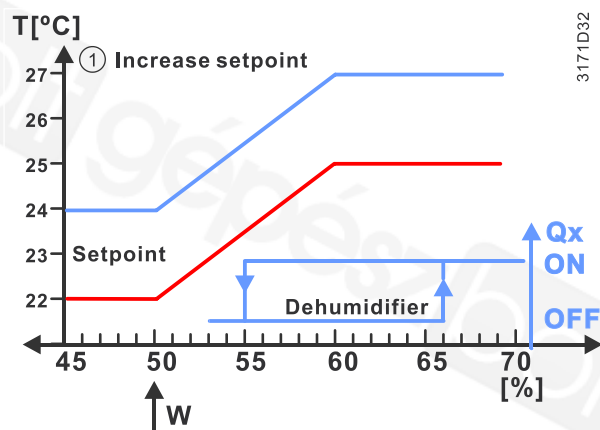
**Note**

For heating and cooling applications, the value of the dead zone (P055) must be bigger than the maximum shifting temperature setpoint (P461), to avoid changeover between heating and cooling sequences in the event of fast humidity changes in the room.

**P461 < 0 K**

For applications with powerful cooling water systems (temperature of cold surfaces is lower than the dewpoint temperature of the humid air), dehumidification can be reached by reducing the room temperature, as the vapor in the air condensates on the surface of the cooling equipment. In this case, set P461 to a negative value (-0.5...-3.0 K).

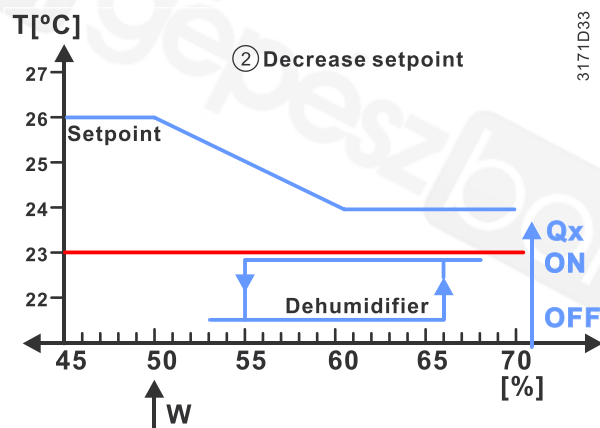
**Note**

This setting is typically used for cooling applications with fan coil units or split units. When the thermostat is in cooling mode or in the dead zone, the temperature setpoint cooling is shifted only when P461 is less than 0 K. The temperature setpoint heating, if available, remains unchanged. The thermostat guarantees a minimum dead zone between both setpoints.

**P461 = 0 K**

When P461 is set to 0 K, the temperature setpoints for heating, cooling or both are not shifted. Dehumidification can be achieved by releasing the relay contact for the dehumidifier. The release contact is switched on at 5% above the high humidity setpoint and off at 5% below.

**Calibration humidity (P007)**

Relative humidity measured by the built-in sensor is also displayed if P009 is set to 5. The sensor can be calibrated (+/-10%) via P007.

When P009 = 5, thermostat can monitor relative humidity via HMI or bus.

For application examples with humidity control, see Humidity control [→ 193].

## 4.6.7 Scheduler

### Scheduler (P005)

The local scheduler function is enabled via P005 (factory setting: disabled) or DIP switch (DIP9 = ON). The DIP switch setting takes priority.

Scheduler allows users to set the following programming modes:

- Set schedule for Comfort and Economy

### Note

- Power reserve clock function (on RDG2..T, standalone versions) runs the internal local time of day for 20 h during power failure to ensure accurate room temperature control as per the scheduler.
- 

### ⚠ WARNING



#### Time synchronization via bus (RDG2..KN)

Time of day and date information are received from a Synco controller with time manager function (RMB, OWZ, etc) or any other KNX device e.g. GPS clock, if the corresponding communication object is bound. We do not recommend using the scheduler function with local time of day, because the internal clock does not run during power failure and must be set after power-up.



### Time of day via bus (RDG2..KN)

Time of day via bus, HMI or Siemens smartphone application PCT Go display on the thermostat (P009 = 3 or 4) in either 12- or 24-hour format. The option selected last is used.

Information is received from a Synco controller with time manager function or any other KNX device, if the corresponding communication object is bound.

### Note

When an application program is downloaded to the Synco devices via ETS, the correct group addresses must also be downloaded to display the time of day on the thermostat (see Synco Knowledge Base - KB771).

### Set schedule

- Press once to select programming mode PROG.
- Press once to enter the scheduler mode .
- Turn the rotary knob to select the weekday to be set and press once.
- Turn the rotary knob to view existing schedules and press once to select the schedule that need to be edited.  
The time value flashes and can be changed by turning the rotary knob.  
ON: Switch to Comfort mode and symbols and are displayed.  
ECO: Switch to Economy mode and symbols and are displayed.
- Press once to confirm the adjusted value.
- If necessary, adjust the time via rotary knob or go back with (Esc) and select a new weekday. Afterwards, adjust the new time the same way as editing a schedule.

### Note

- In Edit mode (value flashes), press to delete schedule or (Esc) to cancel the change. The maximum number of set schedules is three per day.
- In same schedule, the switching point for Economy cannot be earlier than that for Comfort. E.g. Comfort is from 8:00 to 11:00 and Economy from 11:00 to 15:00. The edited switching point for Economy starts at 10:30. Afterwards, press once to confirm the change. No other schedule can be viewed until the Economy switching point is set later than 11:00.

### Schedule overlap

If the start time or end time of a new schedule lies within range of an existing schedule, the schedule is combined with the existing one (OR function).

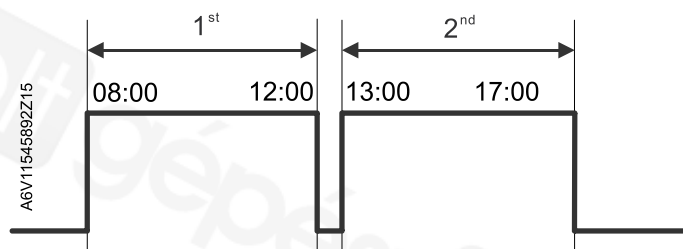
**Example 1:**

The 1<sup>st</sup> schedule is 8:00...12:00 and the 2<sup>nd</sup> is 13:00...17:00. If the newly added schedule starts at 10:00 and ends at 12:30, the schedule order is 1<sup>st</sup> schedule (8:00...12:30) and 2<sup>nd</sup> schedule (13:00...17:00) after the change is confirmed by pressing ✓.

**Example 2:**

The 1<sup>st</sup> schedule is 8:00...12:00 and the 2<sup>nd</sup> is 13:00...17:00. If the newly added schedule starts at 10:00 and ends at 13:30, the schedule is 8:00...17:00 after the change is confirmed by pressing ✓.

**Notes****For apartments with local scheduler and time / date synchronization via KNX (RDG2..KN)**

When the local scheduler is enabled (P005):

- When P002 (operation via room op. selector) = 1 or 2, the manual selected operating mode on the HMI remains in that mode until the user intervention to select a new operating mode. P002 = 3 is no longer available.
- When Auto is selected, the thermostat works according to the local scheduler (operating mode switches between Comfort or Economy).
- In Auto Comfort, changing the setpoint value does not switch the operating mode to Comfort permanently.
- In Auto Economy, changing the setpoint value switches the operating mode to Auto Comfort with the new setpoint. Temporary timer symbol ⌚ is displayed. Selecting green/red leaf function resets operating mode back to Auto Economy.

The local scheduler takes priority over the bus scheduler. KNX room "op.mode: scheduler" has no impact on the operating mode.

| Operating mode on LCD | P002 = 1                                             | P002 = 2                                    | P002 = 3 |
|-----------------------|------------------------------------------------------|---------------------------------------------|----------|
| <b>AUTO</b>           | Switching operating mode between Comfort and Economy |                                             | N/A      |
| <b>ON</b>             | Operating mode remains permanent in Comfort          |                                             |          |
| <b>ECO</b>            | N/A                                                  | Operating mode remains permanent in Economy |          |
| <b>OFF</b>            | Operating mode remains permanent in Protection       |                                             |          |

#### 4.6.8 M/S, manager/subordinate (RDG2..KN)

**Note**

The M/S - manager/subordinate function is not supported with the PXC 4, 5, and 7 PL-Link integration.

The M/S - manager/subordinate function has the following features:

- For large rooms / open spaces, to save energy by synchronizing HVAC equipment and avoid running different equipment in heating and cooling at the same room.
- The manager provides the room temperature, setpoint, operating mode heating / cooling sequence and humidity value and manual fan speed setting (if requested) to all subordinates in the same group.
- When P008 (standard display) is set to 1 (Setpoint), the current Comfort setpoint is always displayed, even if the thermostat works in a different operating mode.
- A group includes max.1 manager and 9 subordinates.
- Manager and subordinates must be set in the same geographical zone via setting geographical zone (apart.) P901 and geographical zone (room) P902.
- Synchronization works even if the manager and subordinate are different products or set with different applications.
- The thermostat can be set as subordinate via parameter P258 and each subordinate can be identified via one identification number (P259). The identification is relevant with alarm management between subordinate and manager.
- When the thermostat is set as subordinate, the HMI is locked and users cannot operate the thermostat locally. At the same time, some parameters are invisible and non-accessible for setting (see Control parameters [→ 163]).
- Fan state and setting of M/S - manager/subordinate are independent. The fan state depends on the fan setting of each device, i.e., manager and subordinate can display different fan speeds.
- All M/S - manager/subordinate settings are set via mobile app PCT Go, KNX tools ETS, Synco ACS or locally on the HMI (parameter setting mode).
- Alarm indication: All active subordinate alarms, e.g. condensation alarm, are displayed on the subordinate. At the same time only the higher priority alarm (see Alarm management manager/subordinate [→ 73]) is displayed on the manager with subordinate identification number. This function is available only when a subordinate identification number is set from 1 to 9. If the identification number is set to Off, the subordinate does not send alarms to the manager.

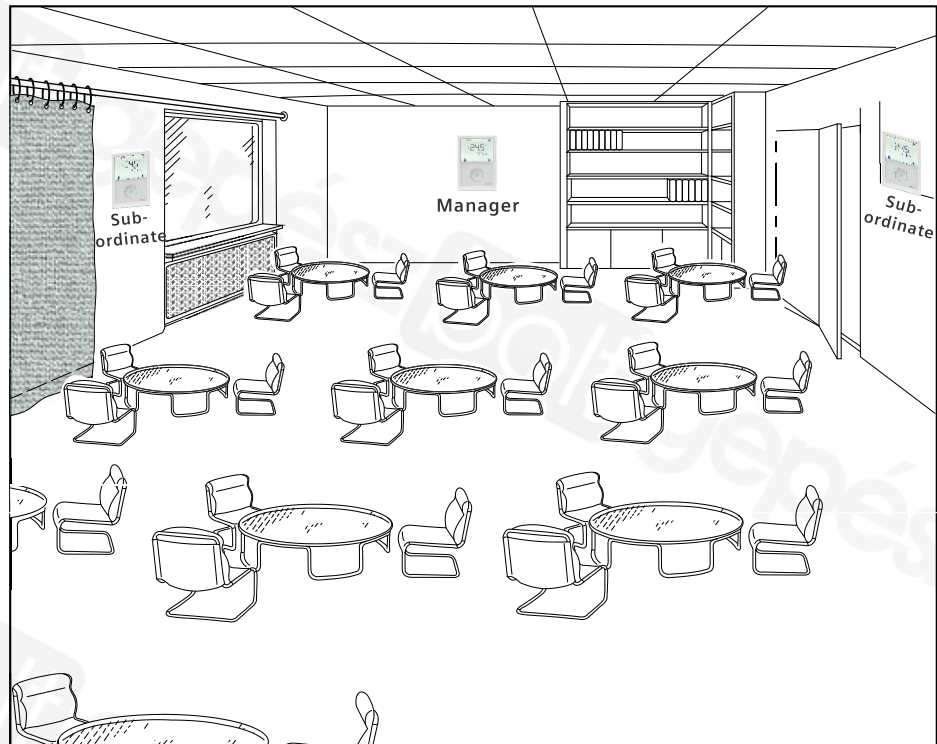

### Window contact

On the manager: The manager switches the group's operating mode depending on the window contact state. The operating mode returns to Comfort when the window is closed.

The window contact state is provided via either local input or bus. When the thermostat receives information from both sources, the local input takes priority.

On the subordinate: Only the subordinate connected to the local window contact switches the operating mode to Protection when the window contact is active. The subordinate does not synchronize the manager's operating mode until the window is closed.

The subordinate does not receive window states from the bus.

### Presence detector

Only the presence detector on the manager (external or built-in) controls the M/S - manager/subordinate loop accordingly.

Presence detection on local input takes priority.

### Setting manager / subordinate

The M/S - manager/subordinate is configured via ETS/ACS or Siemens smartphone application PCT Go.

### Basic setting

Set the thermostat as subordinate: (Default parameter setting is manager.)

- Set subordinate: P258 = 0 (subordinate)
- Set subordinate identification number (P259 = 1...9) to send alarm information to the manager.
- Set manager/subordinate devices in the same zone via Geographical zone apartment (P901) and room (P902)

### Advance setting

- To always display the Comfort setpoint, set P008 = 1 on manager and subordinates.
- If the setpoint (P010) of the manager is set to "save energy", the subordinate needs to be set the same.
- The setpoint limitation range (P013 to P016) of the subordinate can be smaller than the limitation of the manager if requested.
- Together with the Synco devices, set the distribution zone heating / cooling as needed (P903 to P905)



### 4.6.8.1 Alarm management manager/subordinate

The manager receives faults and alarms from its subordinates and displays the higher priority alarm with the subordinate identification number in the order received. If the manager has its own faults and alarms, it displays them instead.

The subordinate sends the fault or alarm with highest priority to the manager. If the priority of a new fault or alarm is higher than that sent, the subordinate sends the new one to replace the original.

The table below shows error codes and default alarm texts.

| Priorities | Fault                                   | Error code             |                                  |
|------------|-----------------------------------------|------------------------|----------------------------------|
|            |                                         | Display on subordinate | Display on manager <sup>1)</sup> |
| 1          | Condensation error                      | COND                   | CON.x                            |
| 2          | External fault input 1                  | AL1                    | AL1.x                            |
| 3          | External fault input 2                  | AL2                    | AL2.x                            |
| 4          | External fault input 3                  | AL3                    | AL3.x                            |
| 7          | External/remote sensor error (physical) | Er3                    | ER3.x                            |
| 8          | External/remote sensor error (physical) | Er4                    | ER4.x                            |
| 9          | External/remote sensor error (physical) | Er5                    | ER5.x                            |

<sup>1)</sup> "x" indicates the subordinate identification number.

For other faults and alarms, see Fault and alarms function on KNX [→ 151].

**Note**

When P259 (subordinate identification) is set as 0, subordinate cannot send alarm to manager.

### 4.6.8.2 Manager/subordinate communication in LTE-Mode

The manager thermostat shares the configuration with its subordinates for the following:

- Room temperature and humidity value
- Operating mode
- Manual fan speed
- Current room setpoint and ChangeOverWaterStatus

If any of the above values is changed on the manager, the change is synchronized to all subordinates within the same zone. For M/S - manager / subordinate configuration, see M/S, Manager/subordinate configuration in LTE-Mode [→ 147].

**Note**

After initial power-on, without changes on the HMI, synchronization between manager and subordinate may take up to 15 min.

Every change on the manager HMI, e.g. setpoint, op. mode, etc, is immediately sent and updated on the subordinate.

A heartbeat function communicates between manager and subordinate objects.

The function ensures that information is synchronized and correct between manager and subordinates. See Send heartbeat and receive timeout [→ 150].

### 4.6.8.3 Manager/subordinate communication in KNX S-Mode

The manager thermostat shares the following values with the subordinate:

- Room temperature and humidity value
- Operating mode
- Manual fan speed
- Current room setpoint and ChangeOverWaterStatus

If any one of the above values changes on the manager, the changes are synchronized to all units within the group. See M/S, Manager/subordinate configuration in KNX S-Mode [→ 142].

#### User case:

- Users change operating mode, comfort setpoint, control sequence, and manual fan speed on the manager thermostat. The data is then transmitted to the subordinates.
- The changes are synchronized to all subordinates.

|                   | S-Mode objects manager |                                               |   |       | S-Mode objects subordinate                     |  |
|-------------------|------------------------|-----------------------------------------------|---|-------|------------------------------------------------|--|
| Setpoint:         | [90]                   | Room temp: Current cooling setpoint (send)    | ➔ | [93]  | Room temp: Current cooling setpoint (receive)  |  |
|                   | [91]                   | Room temp: Current heating setpoint (send)    | ➔ | [92]  | Room temp: Current heating setpoint (receive)  |  |
|                   | [27]                   | Room temp: Comfort setpoint abs (send)        | ➔ | [26]  | Room temp: Comfort setpoint abs (receive)      |  |
| Room temperature: | [37]                   | Built-in room temperature value               | ➔ | [36]  | External room temperature value                |  |
| Room humidity:    | [77]                   | Built-in room relative humidity value [%r.h.] | ➔ | [78]  | External room relative humidity value [% r.h.] |  |
| Operation mode:   | [17]                   | Room operating mode: Status                   | ➔ | [94]  | Room operating mode: Status (receive)          |  |
| ChangeOver Water: | [95]                   | ChangeOverWater status                        | ➔ | [96]  | ChangeOverWater status                         |  |
| Fan speed:        | [97]                   | Manual fan command value (send)               | ➔ | [52]  | Fan command value                              |  |
|                   | [51]                   | FanStatus                                     | ➔ | [50]  | FanManual                                      |  |
| Room air quality  | [100]                  | Built-in room air quality value               | ➔ | [101] | External room air quality value                |  |

#### Note

A heartbeat function communicates between manager and subordinate objects.

The function ensures that information is synchronized and correct between manager and subordinates. See Send heartbeat and receive timeout [→ 150].

### 4.6.9 Preventive operation

#### Avoid cold air in heating mode (P365)

For the heating coil to reach its temperature, fan start can be delayed by a time period set via P365.

#### Avoid damage from moisture (P363, P364)

In very warm and humid climates, the fan runs periodically or continuously at a low fan speed (e.g., in empty apartments or shops) in Economy mode via P364, to avoid damage from moisture due to lack of air circulation. Refer to "Fan kick" function in Fan control [→ 131].

## 4.6.10 NFC communication

### NFC (P500)

NFC (near-field communication) is used to commission the thermostat via the Siemens smartphone application PCT Go.

The distance between smartphone and the thermostat must be max. 2 cm while scanning the NFC area on the individual package or antenna area of the thermostat. Data exchange between controller and Siemens smartphone application is 10 s.

P500 enables/disables NFC communication locally. When disabled (default is enabled), the application cannot read or write the thermostat and message "NFC communication is disabled on the thermostat." is displayed.

Using Siemens smartphone application, users can:

- Set, read or download thermostat parameter settings
- Enable or disable password protection by configuring P502
- Import and export the setting parameter list in CSV format
- Set and download schedules

### Note:

- When NFC communication is enabled, the parameters can be configured even if the thermostat has no power.
- The phone must have active NFC functionality.

For commissioning via Siemens smartphone application PCT Go, see Commissioning.

## 4.6.11 CO<sub>2</sub> (IAQ) monitoring and control (RDG2..4KN)

RDG204KN and RDG264KN with built-in CO<sub>2</sub> sensor can be used for:

- Monitoring CO<sub>2</sub> levels in the room and notifying users to act (e.g., opening the windows) or operating external equipment, in case of high CO<sub>2</sub> concentrations.
- Controlling CO<sub>2</sub> levels by operating external equipment and providing fresh air to the room when concentration exceeds the selected IAQ setpoint. The IAQ control only runs when the thermostat operating mode is Comfort.

Note:

The thermostats / CO<sub>2</sub> sensors are maintenance free, and the typical applications are offices, schools, museums, shops, etc.

However, to maintain accurate CO<sub>2</sub> readings over time, the thermostat must be exposed to the fresh air on regular basis. This is generally the case in well ventilated buildings over night without human presence or when windows are opened.

As a consequence, we recommend not installing RDG2..4KN in spaces where there is 24h/7 occupancy, such as hospitals, airports, hotel lobbies.

### CO<sub>2</sub> sensor calibration

RDG2..4KN uses a maintenance-free CO<sub>2</sub> sensor.

The ASC (automatic self-calibration) algorithm maintains an accurate CO<sub>2</sub> reading over time when the thermostat is regularly exposed to the fresh air (400 ppm). As is the case in well-ventilated buildings over night without human presence or when windows are opened. Wait 9 days to see the impact of the calibration on the CO<sub>2</sub> measure accuracy. The thermostat must always be powered. Powering off and on the device may result in wrong CO<sub>2</sub> indications for several days and delay ASC.

### Installation and commissioning

The DC damper is connected to multifunction output U1. For those applications, U1 is not available as a multifunctional input (P155).

The CO<sub>2</sub> sensor is very sensitive to mechanical force. Avoid as much as possible mechanical shocks, drops or vibrations during transport or installation, which could cause a noticeable CO<sub>2</sub> deviation after installation. When this occurs, we recommend waiting up to 2 or 3 weeks before retesting the CO<sub>2</sub> measurement.

### 4.6.11.1 CO<sub>2</sub> (IAQ) monitoring (RDG2..4KN)

#### CO<sub>2</sub> monitoring (P450 = 0)

The easiest way to monitor CO<sub>2</sub> levels in a room or building, e.g. school or office, is to install or replace the existing thermostat with RDG2..4KN, with its built-in CO<sub>2</sub> sensor and ability to provide CO<sub>2</sub> indications on the screen and over the bus.

The RDG2..4KN can also be used as standalone device. A bus connection is not required for on-screen CO<sub>2</sub> indications.

The CO<sub>2</sub> monitoring function can be enabled for all fan coil and universal heating / cooling applications (without fan control).

Set P450 (Control strategy) = 0 and P009 (Additional display information) to the requested IAQ information on the display.

#### CO<sub>2</sub> indication (P009)

When P009 is set as follows, CO<sub>2</sub> information is displayed as a numeric (concentration in ppm) or text (GOOD, FAIR, BAD) value, together with the IAQ symbol ☼:

- P009 = 6: Indication CO<sub>2</sub> concentration in ppm
- P009 = 7: Indication indoor air quality level as text, e.g. GOOD
- P009 = 8: Indication humidity (%) and CO<sub>2</sub> concentration (ppm)
- P009 = 9: Indication humidity (%) and IAQ level as text, e.g. GOOD

When P009 is set as 8 or 9, the alternating display interval of humidity and IAQ values is 10 s.

**Note:** The CO<sub>2</sub> measured value is not stable until 5 minutes after power on.

#### CO<sub>2</sub> in ppm

##### Selection P009 = 6 or 8: Indication of CO<sub>2</sub> concentration in ppm

The CO<sub>2</sub> concentration in ppm is displayed on the second line with the IAQ symbol ☼.



Maximum display: 5000 ppm

#### CO<sub>2</sub> level

##### Selection P009 = 7 or 9: Indication of indoor air quality level as text

The indoor air quality level is displayed on the second line as follows.

GOOD

Recommended thresholds for occupant wellbeing

- IAQ monitoring (P450 = 0 or 1)  
CO<sub>2</sub> concentration < 800 ppm
- IAQ control (P450 = 2 or 3)  
CO<sub>2</sub> concentration < IAQ setpoint (P023)

FAIR

Ventilation or open windows help dilute the air and increase fresh air levels for occupant wellbeing.

- IAQ monitoring (P450 = 0 or 1)  
CO<sub>2</sub> concentration is between 800 and 1200 ppm.
- IAQ control (P450 = 2 or 3)  
CO<sub>2</sub> concentration is between "IAQ setpoint (P023)" and "IAQ setpoint (P023) + P-band Xp (P454, P456)".

**IAQ** Higher concentrations may result in decreased performance. Add fresh air to the room.

- IAQ monitoring (P450 = 0 or 1)  
CO<sub>2</sub> concentration > 1200 ppm
- IAQ control (P450 = 2 or 3)  
CO<sub>2</sub> concentration > "IAQ setpoint (P023) + P-band Xp (P454, P456)"

The "CO<sub>2</sub> display text" and MENU, e.g. scheduler, can be displayed in different languages by selecting P031 (Language).

The indication has a maximal length of 4 characters.

**IAQ CO<sub>2</sub> concentration, level indication:**

| EN   | DE   | FR   | IT   | ES   | NL   | FI   | HU   |
|------|------|------|------|------|------|------|------|
| GOOD | GUT  | BON  | BUON | BIEN | GOED | GOOD | GOOD |
| FAIR | FAIR | FAIR | OK   | OK   | OK   | FAIR | FAIR |
| BAD  | BAD  | BAS  | BASS | MALA | LAAG | BAD  | BAD  |

| CZ   | DK   | NO   | PL   | RO   | SK   | TR   | GR   |
|------|------|------|------|------|------|------|------|
| GOOD | GOOD | GOD  | GOOD | GOOD | GOOD | IYI  | GOOD |
| FAIR | FAIR | OK   | FAIR | FAIR | FAIR | ORTA | FAIR |
| BAD  | BAD  | DLIG | BAD  | BAD  | BAD  | KOTU | BAD  |

**Error display**

- The thermostat displays "---" if the received value is ≥5000 ppm.
- The thermostat displays "ER6" if sensor is broken.

### 4.6.11.2 CO<sub>2</sub> (IAQ) control in the room (RDG2..4KN)

**CO<sub>2</sub> control (P450, P023)** The function improves indoor air quality by increasing the volumetric air flow. IAQ control is only available when the thermostat is in Comfort mode.

The function is disabled on the other operating modes.

When P450 is set as 2 (T + IAQ) or 3 (T + r.h. + IAQ), IAQ control is enabled. This function adjusts indoor air quality via damper when the measured IAQ - CO<sub>2</sub> is higher than the setpoint (P023). The factory setting is 1000 ppm.

The fresh air symbol  displays when the damper is open.



**Room air quality:  
Setpoint [ppm] (P023)**

The IAQ can be adjusted via KNX S-Mode object 107.

**CO<sub>2</sub> control and air  
cooling (P450, P023)**

IAQ control + air cooling is only available when the thermostat is in Comfort mode. The function is disabled on the other operating modes.

When P450 is set as 5 (T + IAQ + air cooling) or 6 (T + IAQ + air cooling plus), IAQ control + air cooling is enabled. This function adjusts indoor air quality via damper when the measured IAQ - CO<sub>2</sub> is higher than the setpoint (P023) and provides air cooling in parallel (P450 = 5) or in sequence (P450 = 6). The factory setting is 1000 ppm.

The fresh air symbol  displays when the damper is open.

RDG204KN fan coil and universal (CLC, with no fan) applications with IAQ control + air cooling:

| FCU application                           | CLC app <sup>3)</sup> | Fan <sup>1)</sup> |         | H/C Control outputs signal combination                                                           | Damper signal <sup>2)</sup> |
|-------------------------------------------|-----------------------|-------------------|---------|--------------------------------------------------------------------------------------------------|-----------------------------|
|                                           |                       | DC                | 3-speed |                                                                                                  | DC                          |
| 2-pipe                                    | ✓                     | ✓                 |         | <ul style="list-style-type: none"> <li>On/Off (PWM)</li> </ul>                                   | ✓                           |
|                                           | ✓                     |                   | ✓       | <ul style="list-style-type: none"> <li>3-pos</li> </ul>                                          | ✓                           |
| 2-pipe+ RAD<br>2-pipe+ el. heat<br>4-pipe | ✓                     | ✓                 |         | <ul style="list-style-type: none"> <li>2 x On/Off (PWM)</li> <li>On/Off (PWM) + 3-pos</li> </ul> | ✓                           |
|                                           | ✓                     |                   | ✓       | <ul style="list-style-type: none"> <li>3-pos + On/Off (PWM)</li> <li>2 x 3-pos</li> </ul>        | ✓                           |
|                                           | ✓                     |                   | ✓       | <ul style="list-style-type: none"> <li>2 x On/Off (PWM)</li> <li>3-pos + On/Off (PWM)</li> </ul> | ✓                           |

RDG264KN fan coil and universal (CLC) applications with IAQ control + air cooling:

| FCU application                               | CLC app <sup>3)</sup> | Fan <sup>1)</sup> |         | H/C Control outputs signal combination                                            | Damper signal <sup>2)</sup> |
|-----------------------------------------------|-----------------------|-------------------|---------|-----------------------------------------------------------------------------------|-----------------------------|
|                                               |                       | DC                | 3-speed |                                                                                   | DC                          |
| 2-pipe                                        | ✓                     | ✓                 |         | <ul style="list-style-type: none"> <li>On/Off</li> </ul>                          | ✓                           |
|                                               | ✓                     |                   | ✓       | <ul style="list-style-type: none"> <li>DC</li> </ul>                              | ✓                           |
| 2-pipe+ RAD<br>2-pipe+ el. heat<br>4-pipe     | ✓                     | ✓                 |         | <ul style="list-style-type: none"> <li>2 x On/Off</li> <li>On/Off + DC</li> </ul> | ✓                           |
|                                               | ✓                     |                   | ✓       | <ul style="list-style-type: none"> <li>DC + On/Off</li> <li>2 x DC</li> </ul>     | ✓                           |
| 4-pipe with 6-port ball valve                 | ✓                     |                   |         | <ul style="list-style-type: none"> <li>DC</li> </ul>                              | ✓                           |
| 4-pipe with PICV + 6-port valve as changeover | ✓                     | ✓                 |         | <ul style="list-style-type: none"> <li>On/Off + DC</li> </ul>                     | ✓                           |

<sup>1)</sup> Selectable via P351 (Fan speeds)

<sup>2)</sup> Selectable via P453 (Indoor air quality damper)

3) Universal (CLC) applications can be set by switching off the fan functions (P350 = 0)

**Note for "cooling with air"**

- "Cooling with air" supports cooling demand.
- If changeover water is available, it is always cooling.

The following graphics show U1 output (max of "cooling & IAQ") runs parallel to the cooling valve or starts when cooling valve reaches 100% (sequence).

- P450 = 5: Air ventilation runs in parallel to the cooling valve
- P450 = 6: Cooling air starts when cooling valve reaches 100%

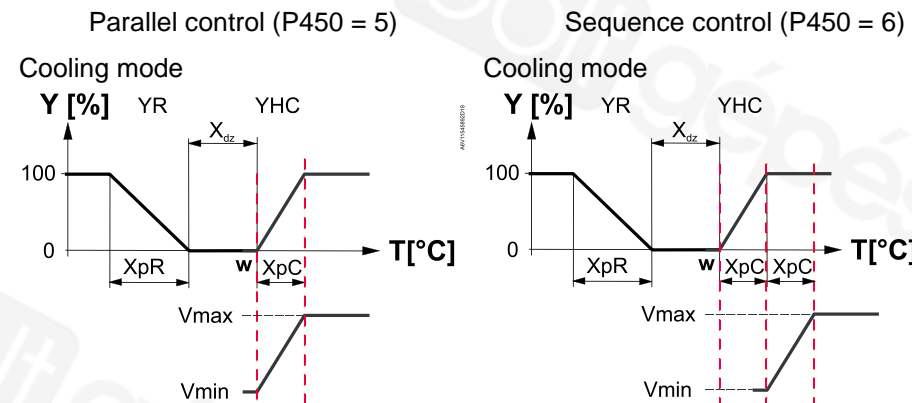

|       |                                         |                 |                                     |
|-------|-----------------------------------------|-----------------|-------------------------------------|
| T[°C] | Room temperature                        | XpR             | Proportional band "Radiator" (P054) |
| w     | Room temperature setpoint               | XpC             | Proportional band "Cooling" (P052)  |
| YHC   | Control command "Valve" or "Compressor" | X <sub>dz</sub> | Dead zone (P055)                    |
| YR    | Control command "Radiator"              | Vmax            | Maximum damper position (P457)      |
|       |                                         | Vmin            | Minimum damper position (P455)      |

**Forced ventilation (P003) (RDG204KN, RDG264KN)**

The function is used to forcibly start the fan to improve indoor air quality. When P003 is set to 4 (forced ventilation), the function can be enabled by pressing . Forced ventilation lasts for 10 minutes by default, which can be selected using the rotary knob. The fresh air symbol , text "For" and actual fan speed display when this function is enabled. When forced ventilation is enabled and there are no user operations, forced ventilation starts after a 2-second timeout. When P350 = 0, P003 is set to 4. When P003 is set to 5 (forced ventilation, fan auto-manual), forced ventilation and auto/manual fan speed can be selected by pressing .

**Note**

Forced ventilation can be stopped by means of the following HMI operations:

- Operating mode change
- Green leaf
- Middle button

**CO<sub>2</sub> control versus temperature control**

The CO<sub>2</sub> control takes precedence (higher priority) over temperature control. The room temperature setpoint may not be maintained during active CO<sub>2</sub> control depending on the size of the HVAC system. Check sizing and balancing if this is the case. The CO<sub>2</sub> setpoint (and P-Band) can be increased as an alternative.

## Supported use cases with IAQ control:

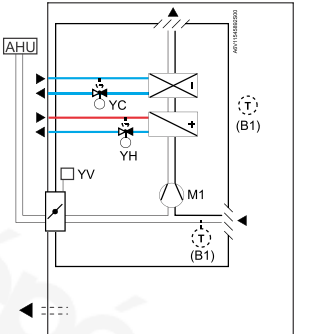
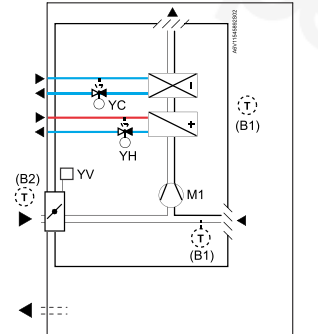
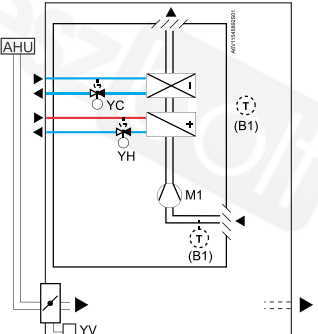
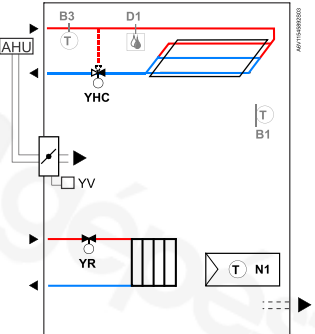
|                                                                                                                                                                                                                                          |                                                                                   |                                                                                                                                                                               |                                                                                                                                                       |
|------------------------------------------------------------------------------------------------------------------------------------------------------------------------------------------------------------------------------------------|-----------------------------------------------------------------------------------|-------------------------------------------------------------------------------------------------------------------------------------------------------------------------------|-------------------------------------------------------------------------------------------------------------------------------------------------------|
| <p>a) Fan coil with integrated damper<br/>Fresh air from ventilation system</p>                                                                                                                                                          | <p>b) Fan coil with integrated damper<br/>Fresh air from outside</p>              | <p>c) Fan coil system RDG2..4KN for CO<sub>2</sub> monitoring.<br/>Optional: Ventilation system for CO<sub>2</sub> control</p>                                                | <p>d) Universal heating/cooling systems.<br/>RDG2..4KN for CO<sub>2</sub> monitoring.<br/>Optional: Ventilation system for CO<sub>2</sub> control</p> |
|                                                                                                                                                         |  |                                                                                             |                                                                    |
| <p>YH Heating valve actuator<br/>YC Cooling valve actuator<br/>YHC Heating/cooling valve actuator<br/>M1 1-speed or 3-speed fan, DC 0...10 V fan<br/>B1 Return air temperature sensor or external room temperature sensor (optional)</p> |                                                                                   | <p>AHU Air handling unit<br/>YV Damper for IAQ control<br/>B2 External air temperature sensor (bus)<br/>YR Radiator valve<br/>B3 Changeover sensor<br/>D1 Dewpoint sensor</p> |                                                                                                                                                       |

- Use case a): IAQ - CO<sub>2</sub> control in fan coil systems with integrated fresh air damper  
The fresh air is provided via an external ventilation system, e.g. an air handling unit (AHU)
- Use case b): IAQ - CO<sub>2</sub> control in fan coil systems with direct fresh air from outside  
By activating the frost protection function and setting the frost protection setpoint (P109), the outside fresh air is provided via damper into the fan coil and then to the room. When the outside temperature (sent to RDG2..4KN via e.g. LTE-mode, zone 31) drops below the frost protection setpoint, the thermostat closes the damper to protect the equipment.
- Use case c): IAQ - CO<sub>2</sub> monitoring (P450 = 0 or 1) or control (P450 = 2 or 3), in traditional fan coil systems (without built-in fresh air damper)  
For CO<sub>2</sub> control, the fresh air is provided via an external ventilation system. Damper controlled via RDG2..4KN is required.
- Use case d): IAQ - CO<sub>2</sub> monitoring (P450 = 0 or 1) or control (P450 = 2 or 3) in universal heating and cooling systems  
For CO<sub>2</sub> control, the fresh air is provided via an external ventilation system. Damper controlled via RDG2..4KN is needed.

The thermostats support indoor air quality control on several HVAC fan coil or universal applications, for different types of control outputs and fan signals. Consult the tables below to determine whether the thermostat can control your equipment:

- Select HVAC application (e.g. 4-pipe)
- Select fan type (DC, 3-speed or no fan (fan disabled))
- Check available control signals (On/Off, PWM, 3-pos, DC)
- Verify availability of IAQ control type (DC or On/Off damper)



RDG204KN fan coil and universal (CLC, with no fan) applications with IAQ control:

| FCU application                                             | CLC app <sup>3)</sup> | Fan <sup>1)</sup> |         | H/C Control outputs signal combination       | Damper signal <sup>2)</sup> |        |
|-------------------------------------------------------------|-----------------------|-------------------|---------|----------------------------------------------|-----------------------------|--------|
|                                                             |                       | DC                | 3-speed |                                              | DC                          | On/Off |
| 2-pipe                                                      | ✓                     | ✓                 |         | • On/Off (PWM)                               | ✓                           | ✓      |
|                                                             | ✓                     |                   | ✓       | • 3-pos                                      | ✓                           | ✓      |
| 2-pipe+ RAD<br>2-pipe+ el. heat<br>2-pipe/2-stage<br>4-pipe | ✓                     | ✓                 |         | • 2 x On/Off (PWM)<br>• On/Off (PWM) + 3-pos | ✓                           | ✓      |
|                                                             | ✓                     |                   | ✓       | • 3-pos + On/Off (PWM)<br>• 2 x 3-pos        | ✓                           |        |
|                                                             | ✓                     |                   | ✓       | • 2 x On/Off (PWM)<br>• 3-pos + On/Off (PWM) |                             | ✓      |
| 4-pipe+ el. heater                                          | ✓                     | ✓                 |         | • 3 x On/Off (PWM)                           | ✓                           | ✓      |
|                                                             | ✓                     |                   | ✓       | • On/Off (PWM) + 3-pos + On/Off (PWM)        | ✓                           |        |
|                                                             | ✓                     |                   | ✓       | • 3 x On/Off (PWM)                           |                             | ✓      |
| 4-pipe/2-stage                                              | ✓                     | ✓                 |         | • 4 x On/Off (PWM)                           | ✓                           | ✓      |
|                                                             | ✓                     |                   | ✓       |                                              | ✓                           |        |

RDG264KN fan coil and universal (CLC) applications with IAQ control:

| FCU application                                             | CLC app <sup>3)</sup> | Fan <sup>1)</sup> |         | H/C Control outputs signal combination | Damper signal <sup>2)</sup> |        |
|-------------------------------------------------------------|-----------------------|-------------------|---------|----------------------------------------|-----------------------------|--------|
|                                                             |                       | DC                | 3-speed |                                        | DC                          | On/Off |
| 2-pipe                                                      | ✓                     | ✓                 |         | • On/Off                               | ✓                           | ✓      |
|                                                             | ✓                     |                   | ✓       | • DC                                   | ✓                           |        |
| 2-pipe+ RAD<br>2-pipe+ el. heat<br>2-pipe/2-stage<br>4-pipe | ✓                     | ✓                 |         | • 2 x On/Off<br>• On/Off + DC          | ✓                           | ✓      |
|                                                             | ✓                     |                   | ✓       | • DC + On/Off<br>• 2 x DC              | ✓                           |        |
|                                                             | ✓                     |                   | ✓       | • 3 x DC<br>• On/Off + 2 x DC          | ✓                           | ✓      |
| 4-pipe/2-stage                                              | ✓                     | ✓                 |         | • 4 x DC                               |                             | ✓      |
| 4-pipe with 6-port ball valve                               | ✓                     |                   |         | • DC                                   | ✓                           | ✓      |
| 4-pipe with PICV + 6-port valve as changeover               | ✓                     | ✓                 |         | • On/Off + DC                          | ✓                           | ✓      |

<sup>1)</sup> Selectable via P351 (Fan speeds)

<sup>2)</sup> Selectable via P453 (Indoor air quality damper)

<sup>3)</sup> Universal (CLC) applications can be set by switching off the fan functions (P350 = 0)

**Note for IAQ control on universal (CLC) heating and cooling systems.**

Application can be set as per Applications for universal systems [→ 47] and by switching off the fan function (P350 = 0).

On applications without fan control, the thermostat controls the position of the damper when the IAQ setpoint P023 is exceeded. An independent fresh air system guarantees fresh air flow to the room.

See the possible combinations of applications, control signals and damper types in the above table for RDG204KN and RDG264KN.

Frost protection function is not available on universal applications.

**IAQ - CO<sub>2</sub> control,  
KNX objects**

IAQ - CO<sub>2</sub> S-Mode objects:

- 100 Built-in room air quality values (out)
- 101 External room air quality values (in, for M/S – manager/subordinate function)
- 102 DC damper demand (1-byte out)
- 103 On/Off damper demand (1-bit in)

The CO<sub>2</sub> concentration is available on the bus via S-Mode object 100 “Built-in room air quality value”. This information can share the CO<sub>2</sub> concentration in the rooms to an independent fresh air controller.

S-Mode object 102 “DC damper demand” and object 103 “On/Off damper demand” can share the current damper position to 3rd party equipment.

When the thermostats use M/S - manager/subordinate function, the CO<sub>2</sub> concentration of the manager can be received from the subordinate device via S-Mode object 101 “external room air quality value”.

**Frost protection (P109)**

Enable IAQ frost protection to protect the coils (set P109 frost setpoint) when fresh air from outside is supplied to the equipment.

Frost protection closes the damper if the outside temperature value from the bus (sent to RDG via e.g. LTE-mode, zone 31) is below the setpoint and open again if the outside temperature increases by 2K (hysteresis) above the setpoint.

Frost protection is not supported if the fan is disabled (P350 = 0) or the application is set to 4-pipe with 6-port valve (H/C no fan). (RDG200KN, RDG260KN, RDG200T, RDG260T)

### 4.6.11.3 CO<sub>2</sub> control with DC damper (P453 = 1)

IAQ - CO<sub>2</sub> control – damper signal (P453, P454, P455, P456, P457, P458)

If DC 0...10 V damper control is selected, the following parameters are available:

- P453: Indoor air quality damper (1 = DC 0...10 V (U1))
- P454: IAQ damper proportional band Xp
- P455: Minimum damper position
- P457: Maximum damper position
- P353, P357: Fan min. output



Min./max. damper position [%] (P455, P457)

Minimum and maximum damper position can be adjusted via KNX S-Mode objects 108, 109.

The following graphics show DC damper position during heating/cooling demand and in the dead zone; the fan is switched on via IAQ demand.

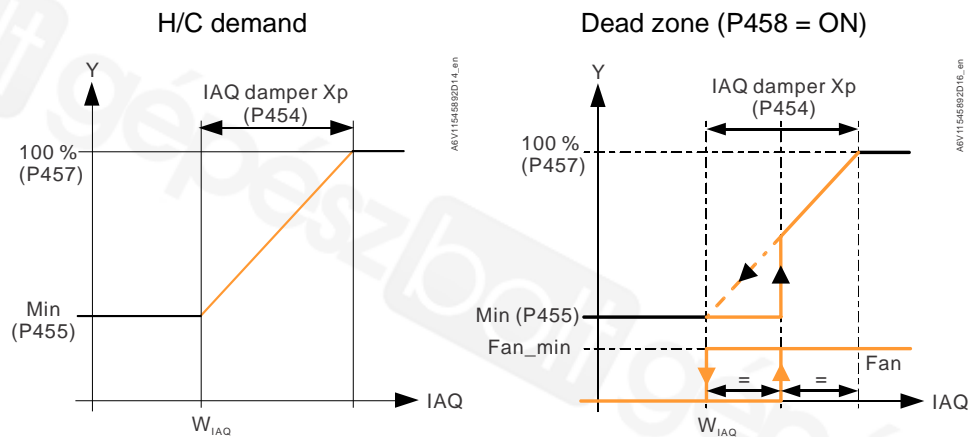

|                  |                                |               |                                   |
|------------------|--------------------------------|---------------|-----------------------------------|
| Min              | Minimum damper position (P455) | IAQ damper Xp | IAQ damper P-band Xp (P454)       |
| W <sub>IAQ</sub> | IAQ setpoint (P023)            | Fan_min       | Min. DC 0...10 V fan speed (P357) |

The damper position is based on CO<sub>2</sub> value. The damper is open if CO<sub>2</sub> (IAQ) concentration is higher than the setpoint (P023).

When an independent air ventilation system provides fresh air to the room, the following setting is relevant:

- When P458 (fan during IAQ control) = ON, the fan runs during IAQ demand.
- When P458 = OFF, the fan does not operate during IAQ demand.

For fan coil systems (P458 = ON) in the dead zone (no H/C demand), the damper does not open, and the fan does not operate until CO<sub>2</sub> concentration reaches IAQ setpoint + ½ P-band.

For universal heating/cooling (without fan control), IAQ demand controls the damper and the fan remains on Off.

DC damper can be connected directly to thermostat terminal U1 or controlled via S-Mode object 102: DC damper demand.

### 4.6.11.3.1 CO<sub>2</sub> control with On/Off damper (P453 = 2 or 3)

If On/Off damper control is selected, the following parameters are available:

- P453: Indoor air quality damper (2 = On/Off (normally open), 3 = On/Off (normally closed))
- P456: IAQ fan P-band Xp
- P357, P353: Fan min. output
- P359 & P360, P355: Fan max. output

The following graphics show the IAQ control by running the fan, in applications with On/Off damper.

DC fan

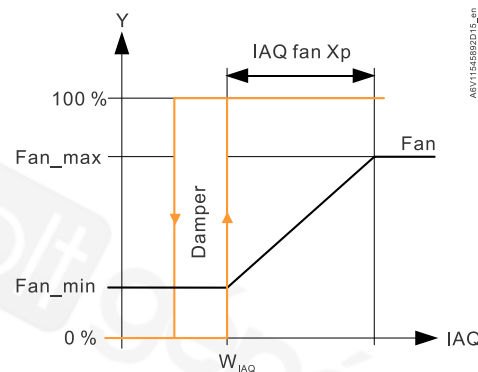

1-speed/3-speed fan

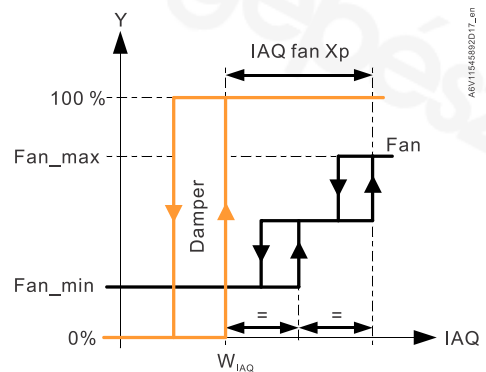

$W_{IAQ}$  IAQ setpoint (P023)

IAQ fan Xp IAQ damper P-band Xp (P456)

Fan\_min Min. DC 0...10 V fan speed (P357)

Fan\_max Max. DC 0...10 V fan speed (P359 for heating & P360 for cooling)

The damper is fully open if CO<sub>2</sub> (IAQ) concentration is higher than the setpoint (P023).

The hysteresis of the damper is fixed at 100 ppm. The 3-speed fan switch off point is 100 ppm below the switch on point.

In the dead zone (no H/C demand), the damper does not open, and fan does not operate until CO<sub>2</sub> concentration reaches the IAQ setpoint.

On/Off damper can be connected directly to thermostat terminal Q3 or Y4 (see IAQ - CO<sub>2</sub> connection diagrams [→ 193]) or controlled via S-Mode object 103: On/Off damper demand.

Notes:

- When On/Off damper is selected, the fan speed depends on the higher fan request between temperature demand and IAQ demand.
- For energizing the damper during IAQ demand, select "IAQ damper" P453 = 3 (normally close).  
This logic can be inverted by selecting P453 = 2 (normally open).

### 4.6.11.3.2 CO<sub>2</sub> control via damper and fan (2-stage) P450 = 4

#### CO<sub>2</sub> control via damper and fan (2-stage) (P450)

For controlling the air quality in the room, some equipment requests to have a 2-stage IAQ control.

For IAQ demand, in the 1<sup>st</sup> stage, the thermostat needs to open the air damper and bring fresh air in the room. In the 2<sup>nd</sup> stage, the fan speed needs to be increased.

The 2-stage IAQ control can be enabled by setting P450 to 4 (temperature, air quality (via damper, fan)).

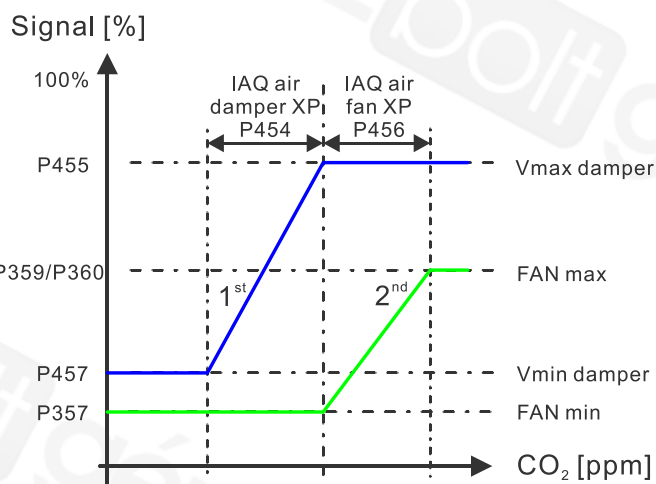

Parameters for the fan and ventilation need to be adjusted for the optimal control performance.

### 4.6.12 Power reserve clock (RDG2..T)

#### Power reserve clock for 20 h during power failure

When the thermostat detects a power failure, all parameters and customer settings (time program, operating mode, setpoint and fan speed) are saved internally and the display switches off.

The clock continues to run during power failure. The display switches on once power resumes. The thermostat reloads the previous settings and continues to operate with the correct clock time.

The correct time clock must be set manually on the thermostat if the power failure exceeds the maximum backup time.

### 4.6.13 Control strategy (P450)

P450 (control strategy) is used to enable and disable control functions of the thermostat.

All thermostats can be set to control the room temperature and humidity (P450 = 0 and 1).

For RDG2..4KN with built-in CO<sub>2</sub> sensor, the thermostat functionality can be extended to control CO<sub>2</sub> concentration by setting P450 to 2, 3 or 4 (default: P450 = 2).

Moreover, in case of cooling demand, cold air from an external ventilation system (e.g., AHU) can be used, by driving the fresh air damper, to reduce the temperature in the room (P450 = 5 or 6).

P450 setting extends the range of applications to:

- Cooling with air combined with fan coil systems, see Cooling with air and IAQ in fan coil systems [→ 111]
- Cooling with air combined with universal H/C system, see Cooling with air and IAQ in universal H/C system [→ 113]
- Cooling with air in ventilation systems, see Cooling with air and IAQ control in ventilation systems [→ 114]

| P450 | Function                                                          | Description                                                                                                                                                                                                                                                                     | RDG2..0T | RDG2..0KN | RDG2..4KN       |
|------|-------------------------------------------------------------------|---------------------------------------------------------------------------------------------------------------------------------------------------------------------------------------------------------------------------------------------------------------------------------|----------|-----------|-----------------|
| 0    | Temperature (T)                                                   | Temperature control                                                                                                                                                                                                                                                             | ✓        | ✓         | ✓               |
| 1    | Temperature (T)<br>+ relative humidity (r.h.)                     | Temperature and humidity control                                                                                                                                                                                                                                                |          | ✓         | ✓               |
| 2    | Temperature (T)<br>+ air quality (IAQ)                            | Temperature, CO <sub>2</sub> (IAQ) control                                                                                                                                                                                                                                      |          |           | ✓               |
| 3    | Temperature + humidity<br>+ air quality                           | Temperature, humidity and CO <sub>2</sub> (IAQ) control                                                                                                                                                                                                                         |          |           | ✓               |
| 4    | Temperature<br>+ air quality (damper, fan)                        | Temperature control and CO <sub>2</sub> (IAQ) 2-stage control <ul style="list-style-type: none"> <li>• 1<sup>st</sup> stage by opening the air damper</li> <li>• 2<sup>nd</sup> by increasing fan speed</li> </ul>                                                              |          |           | ✓ <sup>1)</sup> |
| 5    | Temperature + air quality<br>+ air cooling, 1 <sup>st</sup> stage | Temperature and CO <sub>2</sub> (IAQ) control by opening the air damper. During cooling demand, driving the damper <sup>2)</sup> provides cold air to reduce the temperature in the room.<br>See Cooling with air and IAQ control in ventilation systems [→ 114]                |          |           | ✓ <sup>1)</sup> |
| 6    | Temperature + air quality<br>+ air cooling, 2 <sup>nd</sup> stage | Temperature and CO <sub>2</sub> (IAQ) control by opening the air damper. During cooling demand, cold air, by driving the damper <sup>2)</sup> , supports water cooling system, as 2 <sup>nd</sup> stage cooling<br>See Cooling with air and IAQ in universal H/C system [→ 113] |          |           | ✓ <sup>1)</sup> |

- 1) Supported by RDG2..4KN with SW version V7.2.x or higher
- 2) The control signal of the air damper is driven by the higher value between cooling demand and IAQ demand.

## 4.7 Control sequences

### 4.7.1 Sequence overview (setting via P001)

The main control sequence (water coil sequence of the fan coil unit) can be set via P001.

The following sequences can be activated in the thermostats (with or without auxiliary heating).

The available sequences depend on the application (selected via DIP switches, see Application overview [→ 45]).

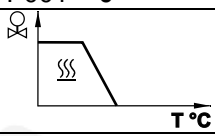
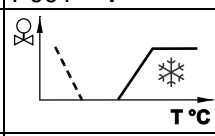
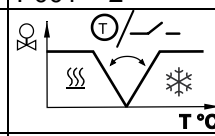
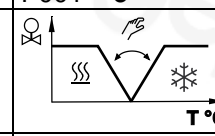
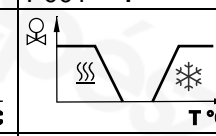
| Parameter                                                                                                                                                                                                                   | P001 = 0                                                                          | P001 = 1                                                                          | P001 = 2                                                                                    | P001 = 3                                                                            | P001 = 4                                                                            |
|-----------------------------------------------------------------------------------------------------------------------------------------------------------------------------------------------------------------------------|-----------------------------------------------------------------------------------|-----------------------------------------------------------------------------------|---------------------------------------------------------------------------------------------|-------------------------------------------------------------------------------------|-------------------------------------------------------------------------------------|
| <b>Sequence</b>                                                                                                                                                                                                             |  |  |           |  |  |
| <b>Available for basic application 1):</b><br>↓                                                                                                                                                                             | Heating                                                                           | Cooling<br>↳ = heating sequence for electric heater/radiator                      | Automatic heating/cooling changeover via external water temperature sensor or remote switch | Manually select heating or cooling sequence (using HMI)                             | Heating and cooling sequence, that is, 4-pipe                                       |
| <ul style="list-style-type: none"> <li>• 2-pipe</li> <li>• 2-pipe with el. heater</li> <li>• 2-pipe with radiator</li> <li>• 2-pipe/2-stage H or C</li> </ul>                                                               | ✓                                                                                 | ✓                                                                                 | ✓                                                                                           | ✓                                                                                   |                                                                                     |
| <ul style="list-style-type: none"> <li>• 4-pipe</li> <li>• 4-pipe with el. heater</li> <li>• 4-pipe/2-stage H and C (RDG2..KN)</li> </ul>                                                                                   |                                                                                   |                                                                                   |                                                                                             | ✓ <sup>2)</sup>                                                                     | ✓                                                                                   |
| <ul style="list-style-type: none"> <li>• 4-pipe with 6-port valve for C/H ceiling</li> <li>• 4-pipe with PICV + 6-port valve as changeover, C/H ceiling or fan coil</li> <li>• 4-pipe with 6-port PICV (RDG26..)</li> </ul> |                                                                                   |                                                                                   |                                                                                             |                                                                                     | ✓ <sup>3)</sup>                                                                     |

<sup>1)</sup> For chilled/heated ceiling and radiator applications, see Chilled/heated ceiling and radiator applications [→ 107];

<sup>2)</sup> For manual changeover with 4-pipe applications, see 4-pipe fan coil unit [→ 100].

- 4-pipe manual changeover (P001 = 3) means activating either cooling or heating outputs

<sup>3)</sup> P001 cannot be configured for applications with 6-port ball valve.

For the relationship between setpoints and sequences, see Setpoints and sequences [→ 122].

## 4.7.2 Application mode



### Application mode

The behavior of the thermostat can be influenced via building automation and control system (BACS) and bus using command "Application mode".

Cooling, heating or both can be enabled or disabled using this signal. Application mode is supported in LTE-Mode and S-Mode.

RDG2..KN KNX thermostats support the following commands:

| # | Application mode | Description                                                                                                                                | Control sequence enabled    |
|---|------------------|--------------------------------------------------------------------------------------------------------------------------------------------|-----------------------------|
| 0 | Auto             | The thermostat automatically changes over between heating and cooling.                                                                     | Heating, cooling or both    |
| 1 | Heat             | The thermostat only allows for heating.                                                                                                    | Heating only                |
| 2 | Morning warm-up  | If "Morning warm-up" is received, the room is heated up as fast as possible (as needed). The thermostat only allows for heating.           | Heating only                |
| 3 | Cool             | The thermostat only allows for cooling.                                                                                                    | Cooling only                |
| 4 | Night purge      | Not supported by fan coil applications.                                                                                                    | N/A (= Auto)                |
| 5 | Pre-cool         | If "Pre-cool" is received, the room is cooled down as fast as possible (as needed). The thermostat only allows for cooling.                | Cooling only                |
| 6 | Off              | Thermostat does not control outputs, that is, all outputs go to off or 0%.                                                                 | Neither heating nor cooling |
| 8 | Emergency heat   | The thermostat heats as much as possible. The thermostat allows only heating.                                                              | Heating only                |
| 9 | Fan only         | All control outputs are set to 0% and only the fan is set to high speed.<br>The function is terminated by any operation on the thermostat. | Run fan at high speed       |

With all other commands, the thermostat behaves as if in Auto mode, thus, heating or cooling by demand.

The heating and cooling states of the thermostat can be monitored with the ACS tool (diagnostic value "Control sequence"). The last active mode is displayed when the thermostat is in the dead zone or temperature control is disabled.



### ACS

#### Heating or cooling

With a 2-pipe application, the control sequence state is determined by the application mode and the state of the heating/cooling changeover signal (via local sensor or bus), or fixed according to the selected control sequence (P001 = heating (0)/cooling (1)).



| Application mode (via bus)       | State changeover/continuous heating or cooling | Control sequence state (ACS diagnostic value) |
|----------------------------------|------------------------------------------------|-----------------------------------------------|
| Auto (0)                         | Heating                                        | Heating                                       |
|                                  | Cooling                                        | Cooling                                       |
| Heat (1), (2), (8)               | Heating                                        | Heating                                       |
|                                  | Cooling                                        | <b>Heating</b>                                |
| Cool (3), (5)                    | Heating                                        | <b>Cooling</b>                                |
|                                  | Cooling                                        | Cooling                                       |
| Night purge (4),<br>Fan only (9) | Heating                                        | Heating                                       |
|                                  | Cooling                                        | Cooling                                       |

### Heating and cooling

With a 4-pipe, 2-pipe with electric heater, and 2-pipe with radiator application, the control sequence state is based on the application mode and heating/cooling demand.

| Application mode (via bus)       | Heating/cooling demand        | Control sequence state (ACS diagnostic value)     |
|----------------------------------|-------------------------------|---------------------------------------------------|
| Auto (0)                         | Heating                       | Heating                                           |
|                                  | No demand                     | Heating/cooling depending on last active sequence |
|                                  | Cooling                       | Cooling                                           |
| Heat (1), (2), (8)               | Heating                       | Heating                                           |
|                                  | No demand                     | <b>Heating</b>                                    |
|                                  | Cooling                       | <b>Heating</b>                                    |
| Cool (3), (5)                    | Heating                       | <b>Cooling</b>                                    |
|                                  | No demand                     | <b>Cooling</b>                                    |
|                                  | Cooling                       | Cooling                                           |
| Night purge (4),<br>Fan only (9) | No temperature control active | Heating/cooling based on last active sequence     |

The diagram below shows the control output value as a function of room temperature for heating and cooling:

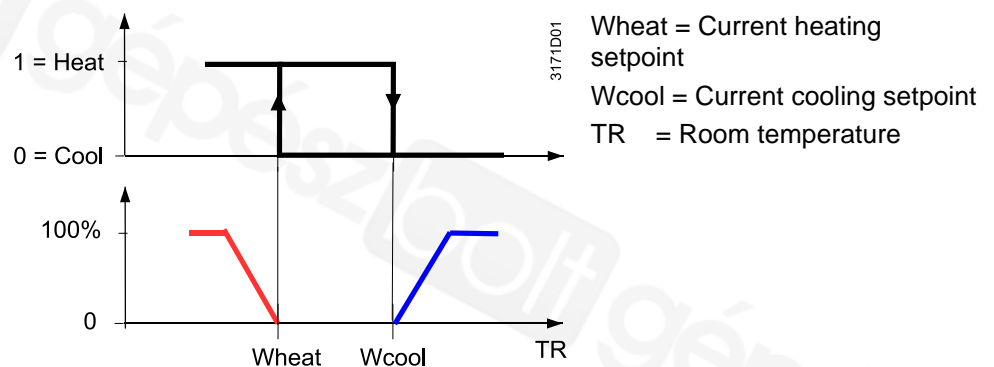

### 4.7.3 2-pipe fan coil unit

In 2-pipe applications, the thermostat controls a valve in heating/cooling mode with changeover (automatically or manually), heating only, or cooling only (factory setting, P001 = 1).

#### On/Off control

Control sequence  
On/Off control output

The diagrams below show the control sequence for On/Off control.

Heating mode

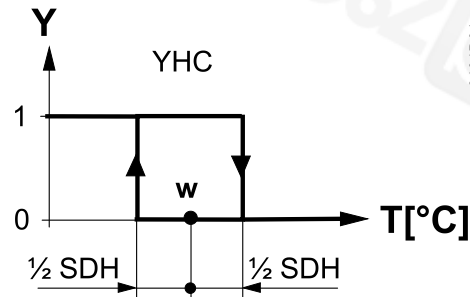

T[°C] Room temperature

w Room temperature setpoint

YHC Control command "Valve"

Cooling mode

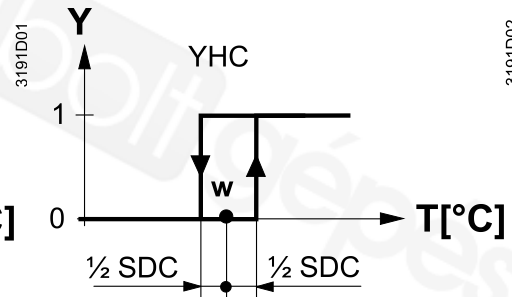

SDH Switching differential "Heating" (P051)

SDC Switching differential "Cooling" (P053)

#### Modulating control: 3-position, PWM or DC 0...10 V

Control sequence  
modulating output

The diagrams below show the control sequence for modulating PI control.

Heating mode

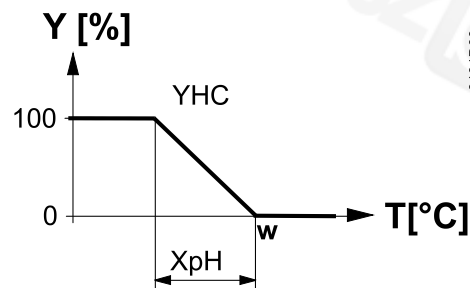

T[°C] Room temperature

w Room temperature setpoint

YHC Control command "Valve"

Cooling mode

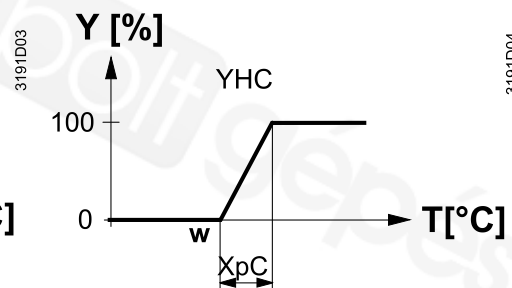

XpH Proportional band "Heating" (P050)

XpC Proportional band "Cooling" (P052)

#### Note

The diagrams only show the PI thermostat's proportional part.

For setting sequence and control outputs, see Application overview [→ 45], Sequence overview (setting via P001) [→ 87] and Control outputs [→ 124].

#### Note

Parameter P256 (RDG264KN only), P260 & P261 (RDG26..) sets the heating/cooling flow limitation. See Additional functions [→ 53].

## 4.7.4 2-pipe fan coil unit with electric heater

### Heating or cooling with auxiliary heater

In 2-pipe applications with electric heater, the thermostat controls a valve in heating/cooling mode with changeover, heating only, or cooling only plus an auxiliary electric heater.

Cooling only is factory-set (P001 = 1) with enabled electric heater (P027).

### Electric heating, active in cooling mode

In cooling mode, the valve receives an Open command if the acquired temperature is above the setpoint.

The electric heater receives an On command if the acquired room temperature drops below "setpoint" minus "dead zone" (= setpoint for electric heater) while the electric heater is enabled (P027 = On).

### Note

"Setpoint for electric heater" is limited by parameter "Maximum setpoint for Comfort mode" (P016).

### Electric heating in heating mode

In heating mode, the valve receives an Open command if the acquired temperature is below the setpoint. The electric heater is used as an additional heat source when the heating energy controlled by the valve is insufficient.

The electric heater receives an On command, if the temperature is below "setpoint" minus "setpoint differential" (= setpoint for electric heater).

### Digital input "Enable electric heater"

Remote enabling/disabling of the electric heater is possible via input X1, X2 or U1 (RDG2..KN)/X3 (RDG2..T) for tariff regulations, energy savings, etc..

Input X1, X2, or U1/X3 must be commissioned accordingly (P150, P153 and P155). See Multifunctional input, digital input [→ 138].



### Enable electric heater

The electric heater can also be enabled/disabled via bus. (RDG2..KN)

### Note

Do not assign the function to a local input X1, X2 or U1 if "Enable electric heater" input is used via bus.

### ⚠ CAUTION



The electric heater must always be protected by a safety limit thermostat!

### On/Off electric heater with DC 0...10 V fan

- With a DC 0...10 V fan, On/Off control for the electric heater can be selected by setting P203 = 4. The electric heater must be connected to outputs Q2 (RDG26..KN), Y2 (RDG20..KN).
- The electric heater starts with a delay of 15 seconds, to ensure the fan supplies sufficient air flow to dissipate the heat (also applies to applications with DC control of the electric heater).
- **⚠ CAUTION! If the fan is disabled, the electric heater is not influenced and may still run.**
- To avoid overheating of the electric heater, the thermostat guarantees at least fan speed medium (Auto fan speed: value in the middle of Vmin (P357) – Vmax (P359), manual fan speed: P358) if the electric heater needs to be energized.

### Adaptive temperature compensation for electric heater

We generally recommend controlling the electrical heater via one external relay. This applies when the application is covered by RDG20..KN (max current output on the triac is 1 A), but also for application with RDG26..KN where the current is lower than the max load supported by Q2.

In this case, an electric heater is connected directly to outputs Q2 (RDG26..KN), and the current heats up the relay contact. This falsifies the internal temperature sensor reading. The thermostat compensates the temperature, if the rated power of the electric heating is entered at P217.

Factory setting P217: 0.0 kW, setting range: 0.0...1.2 kW.

### On/Off control

Control sequence  
On/Off output

The diagrams below show the control sequence for On/Off control.

Heating mode  
(changeover = heating or heating only)

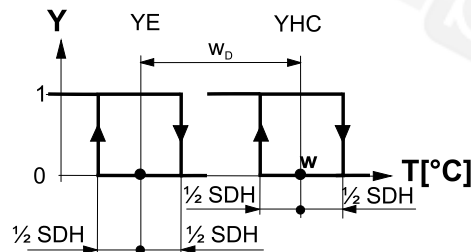

Cooling mode  
(changeover = cooling or cooling only)

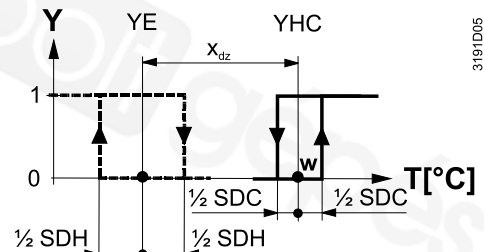

T[°C] Room temperature

w Room temperature setpoint

YHC Control command "Valve"

YE Control command  
"Electric heater"

SDH Switching differential "Heating"  
(P051)

SDC Switching differential "Cooling"  
(P053)

X<sub>dz</sub> Dead zone (P055)

W<sub>D</sub> Setpoint differential (P056)

### Modulating control: 3-position, PWM or DC 0...10 V

Control sequence  
modulating control output

The diagrams below show the control sequence for modulating control.

Heating mode  
(changeover = heating or heating only)

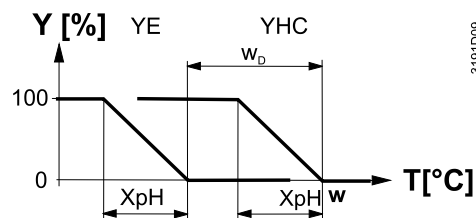

Cooling mode  
(changeover = cooling or cooling only)

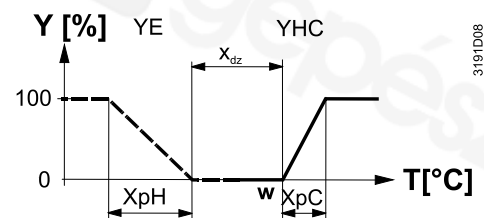

T[°C] Room temperature

w Room temperature setpoint

YHC Control command "Valve"

YE Control command  
"Electric heater"

X<sub>pH</sub> Proportional band "Heating"  
(P050)

X<sub>pC</sub> Proportional band "Cooling"  
(P052)

X<sub>dz</sub> Dead zone (P055)

W<sub>D</sub> Setpoint differential (P056)

### Note

- The diagrams only show the PI thermostat's proportional part.

For setting sequence and control outputs, see Application overview [→ 45], Sequence overview (setting via P001) [→ 87] and Control outputs [→ 124].

### Note

Parameter P256 (RDG264KN only), P260 & P261 (RDG26..) sets the heating/cooling flow limitation. See Additional functions [→ 53].

### 4.7.5 2-pipe fan coil unit with radiator or floor heating

- Heating or cooling with radiator or floor heating** In 2-pipe applications with radiator, the thermostat controls a valve in heating/cooling mode with changeover, heating only, or cooling only plus a radiator valve. Cooling only is factory-set (P001 = 1).
- Radiator, active in cooling mode** In cooling mode, the valve receives an Open command if the acquired temperature is above the setpoint.  
The radiator receives an On command if the acquired room temperature drops below "setpoint" minus "dead zone" (= setpoint for radiator).
- Radiator in heating mode** In heating mode, the radiator receives an Open command if the acquired temperature is below the setpoint. The fan coil unit is used as an additional heat source when the heating energy controlled by the radiator is insufficient.  
The fan coil unit receives an On command if the temperature is below "setpoint" minus "setpoint differential" (= setpoint for fan coil unit).
- Floor heating** The radiator sequence can also be used for floor heating.  
"Floor heating limitation (P252)" function, see Monitoring and limiting functions [→ 59].
- On/Off control** The diagrams below show the control sequence for On/Off control.

Heating mode

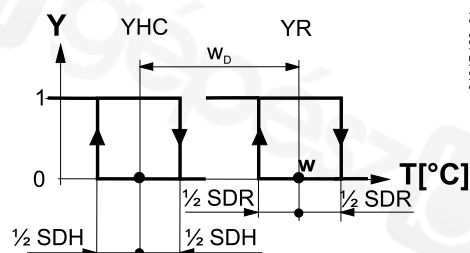

$T$  [°C] Room temperature

$w$  Room temperature setpoint

$YHC$  Control command "Valve" or "Compressor"

$YR$  Control command "Radiator"

Cooling mode

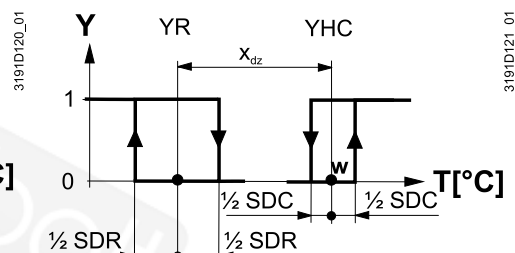

$SDH$  Switching differential "Heating" (P051)

$SDC$  Switching differential "Cooling" (P053)

$SDR$  Switching differential "Radiator" (P054)

$X_{dz}$  Dead zone (P055)

$w_D$  Setpoint differential (P056)

**Modulating control:  
3-position, PWM or  
DC 0...10 V**

The diagrams below show the control sequence for modulating PI control.

**Heating mode**

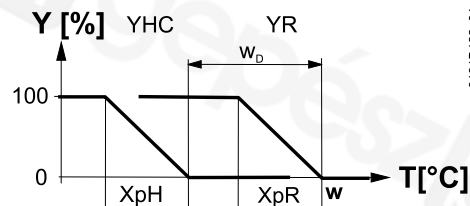

T[°C] Room temperature

w Room temperature setpoint

YHC Control command "Valve" or  
"Compressor"

YR Control command "Radiator"

**Cooling mode**

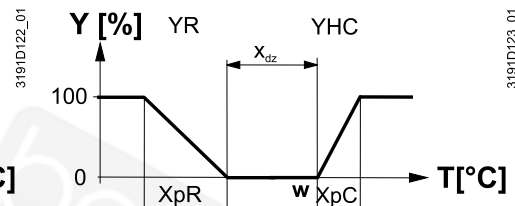

XpH Proportional band "Heating"  
(P050)

XpC Proportional band "Cooling"  
(P052)

XpR Proportional band "Radiator"  
(P054)

Xdz Dead zone (P055)

wD Setpoint differential (P056)

**Note**

The diagrams only show the PI thermostat's proportional part.

For setting sequence and control outputs, see Application overview [→ 45],  
Sequence overview (setting via P001) [→ 87] and Control outputs [→ 124].

**Note**

Parameter P256(RDG264KN only), P260 & P261 (RDG26..) sets the  
heating/cooling flow limitation. See Additional functions [→ 53].

### 4.7.6 2-stage on 2-pipe/4-pipe heating and cooling

#### 2-stage heating or cooling

In 2-stage applications, the thermostat controls 2 valves or 2-stage compressors in series:

- 2-pipe/2-stage: in heating or cooling mode or changeover (automatically or manually). "Cooling only" is factory-set (P001 = 1)
- 4-pipe/2-stage: in heating and cooling mode or changeover (manually). "Heating and cooling" is factory-set (P001 = 4) (RDG2..KN)

#### Fan in the 2<sup>nd</sup> stage

Depending on the equipment, fan control needs to be started in the 2<sup>nd</sup> stage (in the 1<sup>st</sup> stage, the fan remains Off) either in the heating or cooling sequence. To cover the requested application, the fan can be enabled and disabled in different sequences via P350. For further details, see Fan control [→ 134].

#### Limit number of heating/cooling sequence

In the 2-stage application (2-/4-pipe), with parameter P200 "number of heating/cooling sequences", the number of outputs can be set to one cooling sequence (P200 = 2) or one heating sequence (P200 = 3).

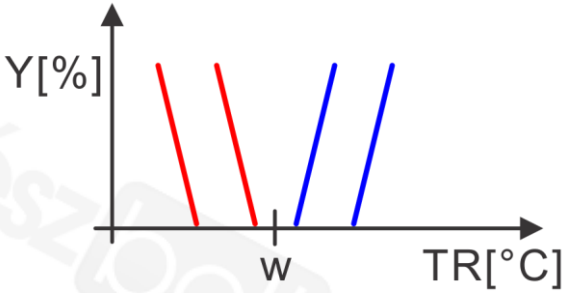
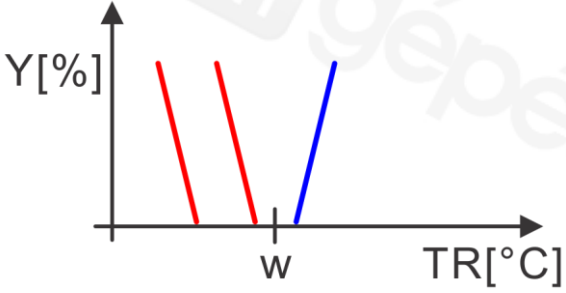
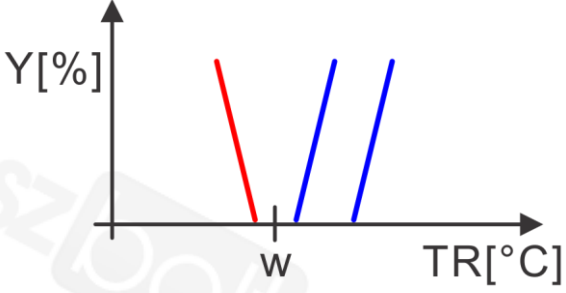
|                           |                                                                                                                                     |
|---------------------------|-------------------------------------------------------------------------------------------------------------------------------------|
| <p>P200 = 1 (default)</p> | <p>Heating 2 sequences, cooling 2 sequences</p>  |
| <p>P200 = 2</p>           | <p>Heating 2 sequences, cooling 1 sequence</p>  |
| <p>P200 = 3</p>           | <p>Heating 1 sequence, cooling 2 sequences</p>  |

### 4.7.6.1 2-pipe/2-stage heating or cooling

#### Heating mode

In heating mode, the 1<sup>st</sup> stage is activated if the acquired temperature is below the setpoint.

The 2<sup>nd</sup> stage is activated if the acquired room temperature drops below "setpoint" minus "setpoint differential".

#### Cooling mode

In cooling mode, the 1<sup>st</sup> stage is activated if the acquired temperature is above the setpoint.

The 2<sup>nd</sup> stage is activated if the acquired room temperature exceeds "setpoint" plus "setpoint differential".

#### Limit number of outputs

For applications with 1-stage heating or 1-stage cooling only, the number of controlled outputs is set via P200 (limit number of heating/cooling sequences).

#### Swap function

With the swap function enabled, the 1<sup>st</sup> stage in heating (YHC1) switches to the 2<sup>nd</sup> stage in cooling. This function optimizes use of heating/cooling energy in systems with different equipment. E.g., fan coil units combined with radiant heating/cooling panels or floor heating/cooling. See Additional functions [→ 53] to enable the function via P254.

#### On/Off output

The diagrams below show the control sequence for On/Off control.

Heating mode (P001 = 0)

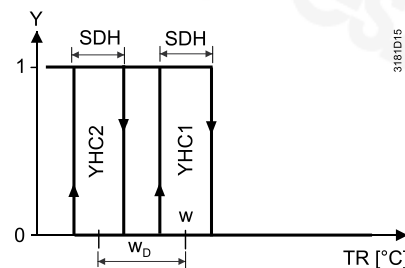

Cooling mode (P001 = 1)

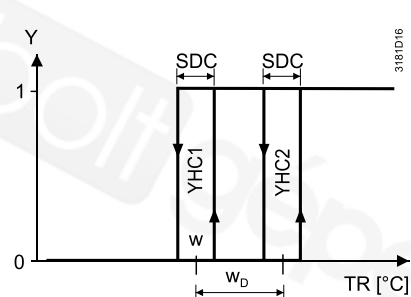

Changeover (P001 = 2 or P001 = 3, P254 = 0)

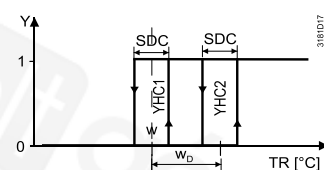

Changeover to cooling

Changeover to heating

Changeover (P001 = 2 or P001 = 3, P254 = 1) (swap function)

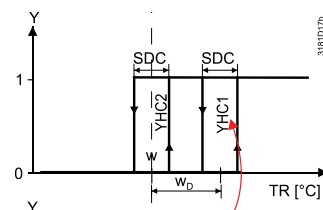

Changeover to cooling (YHC2: 1<sup>st</sup> sequence)

Changeover to heating

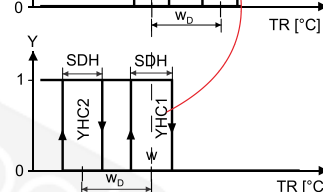
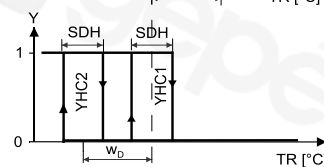

T[°C] Room temperature  
 w Room temperature setpoint  
 YHC1 Control command "Stage 1"  
 YHC2 Control command "Stage 2"

SDH Switching differential "Heating" (P051)  
 SDC Switching differential "Cooling" (P053)  
 w<sub>D</sub> Setpoint differential (P056)



**Modulating control:  
3-position, PWM or  
DC 0...10 V**

The diagrams below show the control sequence for modulating PI control.

Heating mode (P001 = 0)

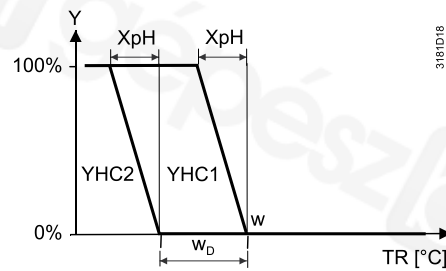

Cooling mode (P001 = 1)

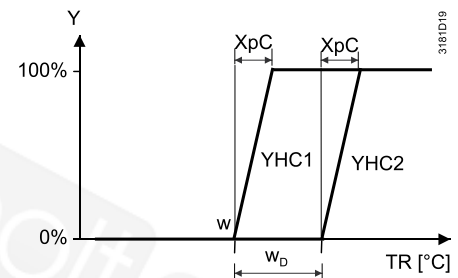

Changeover (P001 = 2 or P001 = 3,  
P254 = 0)

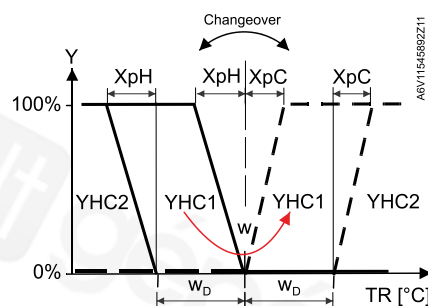

Changeover (P001 = 2 or P001 = 3,  
P254 = 1) (swap function)

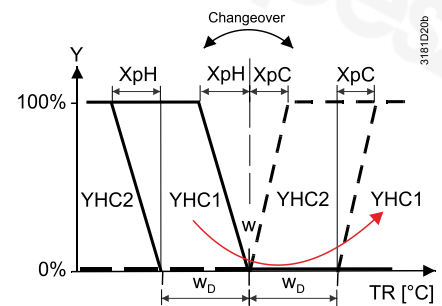

T[°C] Room temperature  
w Room temperature setpoint  
YHC1 Control command "Stage 1"  
YHC2 Control command "Stage 2"

XpH Proportional band "Heating"  
(P050)  
XpC Proportional band "Cooling"  
(P052)  
wd Setpoint differential (P056)

**Note**

The diagrams only show the PI thermostat's proportional part.

For setting sequence and control outputs, see Application overview [→ 45],  
Sequence overview (setting via P001) [→ 87] and Control outputs [→ 124].

**Note**

- For applications with different signals, On/Off (1<sup>st</sup> stage) and DC (2<sup>nd</sup> stage), heating/cooling P-band modulating (P050, P052), a small switching differential SDH / SDC (P051, P053) is suggested to start 1<sup>st</sup> sequence as soon as heating / cooling demand is requested.
- Set the heating/cooling flow limitation function with parameter P256(RDG264KN only), P260 & P261 (RDG26..) in this application. See Additional functions [→ 53].

### 4.7.6.2 4-pipe/2-stage heating and cooling (RDG2..KN)

#### Heating and cooling mode

In 4-pipe/2-stage applications, the thermostat controls max. 4 valves in heating and cooling mode or heating/cooling mode by manual selection. Heating and cooling mode (P001 = 4) is factory-set.

The 1<sup>st</sup> stage is activated when the acquired temperature is below (heating) or above (cooling) the setpoint.

The 2<sup>nd</sup> stage is activated when the acquired room temperature exceeds the "setpoint differential" value.

In heating and cooling mode, the 1<sup>st</sup> and 2<sup>nd</sup> stage for heating or cooling can be activated at same time.

#### Limit number of outputs

For applications with only 1-stage heating or 1-stage cooling, the number of controlled outputs can be set to 3 via P200 (limit number of heating/cooling sequence) accordingly.

#### On/Off output

The diagrams below show the control sequence for On/Off control.

#### Note

RDG26..KN can not be set as On/Off control output and is fixed as DC control output.

Heating and cooling mode (P001 = 4)

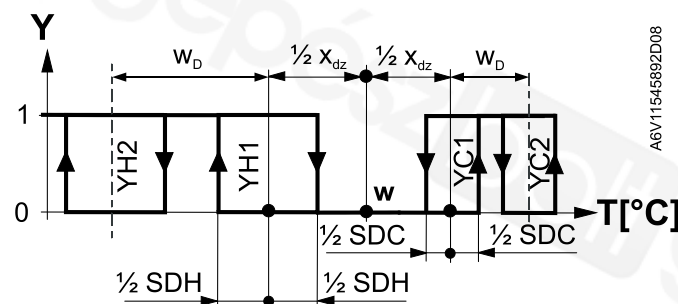

Heating mode with manual selection (P001 = 3) or save energy (P010 = 2 & P014) in heating sequence

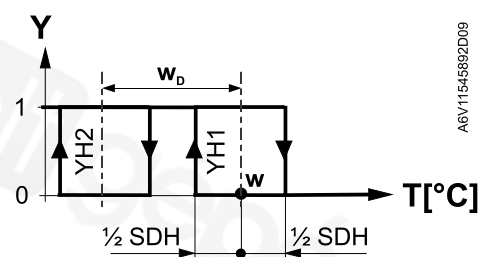

Cooling mode with manual selection (P001 = 3) or save energy (P010 = 2 & P015) in cooling sequence

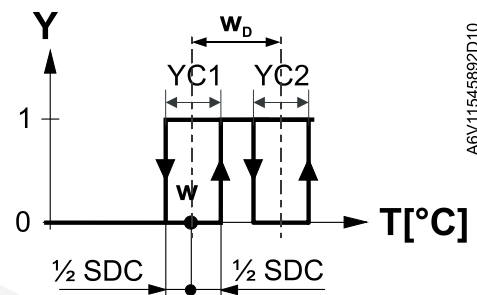

T [°C] Room temperature

w Room temperature setpoint

X<sub>dz</sub> Dead zone (P055)

W<sub>D</sub> Setpoint differential (P056)

YH1, YC1 Control command "Valve" stage 1

YH2, YC2 Control command "Valve" stage 2

SDH Switching differential "Heating" (P051)

SDC Switching differential "Cooling" (P053)

**Modulating control:  
PWM or DC 0...10 V**

The diagrams below show the control sequence for modulating PI control.

Heating and cooling mode (P001 = 4)

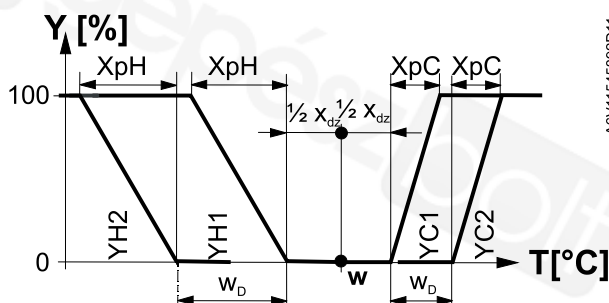

Heating mode with manual selection  
(P001 = 3) or  
to save energy (P010 = 2 & P014) in the  
heating sequence

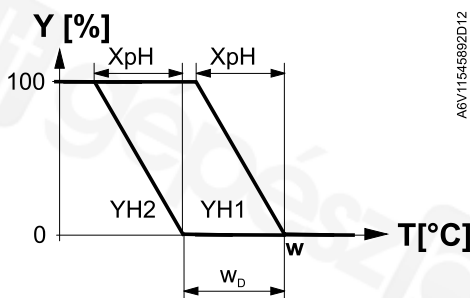

Cooling mode with manual selection  
(P001 = 3) or  
to save energy (P010 = 2 & P015) in the  
cooling sequence

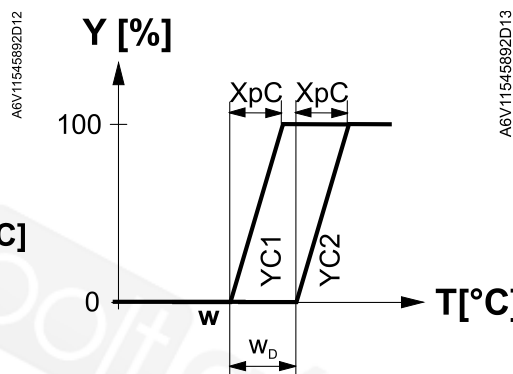

|                 |                              |          |                                    |
|-----------------|------------------------------|----------|------------------------------------|
| T[°C]           | Room temperature             | YH1, YC1 | Control command "Valve" stage 1    |
| w               | Room temperature setpoint    | YH2, YC2 | Control command "Valve" stage 2    |
| X <sub>dz</sub> | Dead zone (P055)             | XpH      | Proportional band "Heating" (P050) |
| w <sub>D</sub>  | Setpoint differential (P056) | XpC      | Proportional band "Cooling" (P052) |

**Note** The diagrams only show the PI thermostat's proportional part.

For setting sequence and control outputs, see Application overview [→ 45], Sequence overview (setting via P001) [→ 87] and Control outputs [→ 124].

- Note**
- For applications with different signals, On/Off (1<sup>st</sup> stage) and DC (2<sup>nd</sup> stage), heating/cooling P-band modulating (P050, P052), a small switching differential SDH / SDC (P051, P053) is suggested to start 1<sup>st</sup> sequence as soon as heating / cooling demand is requested.
  - Set the heating/cooling flow limitation function with parameter P256(RDG264KN only), P260 & P261 (RDG26..) in this application. See Additional functions [→ 53].

### 4.7.7 4-pipe fan coil unit

#### Heating and cooling

In 4-pipe applications, the thermostat controls 2 valves in heating and cooling mode, heating/cooling mode by manual selection. Heating and cooling mode (P001 = 4) is factory-set.

#### 4-pipe application with manual changeover

The heating or cooling output can be released via operating mode button if P001 is set to Manual (P001 = 3).

#### On/Off control

The diagrams below show the control sequence for On/Off control.

Heating and cooling mode (P001 = 4)

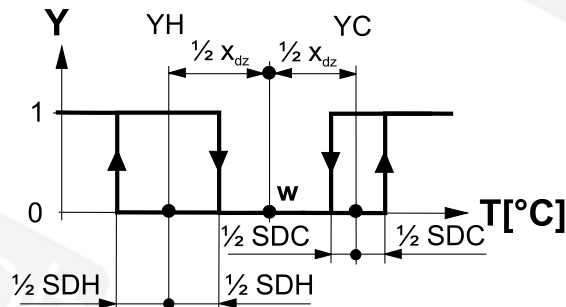

Heating mode with manual selection (P001 = 3) or energy saving (P010 = 2 & P014) in heating sequence

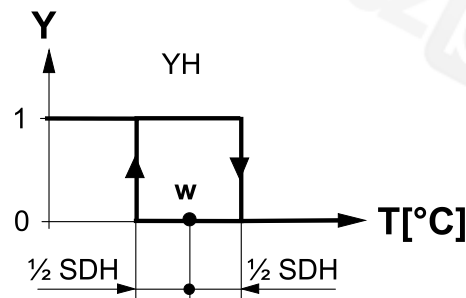

Cooling mode with manual selection (P001 = 3) or energy saving (P010 = 2 & P015) in cooling sequence

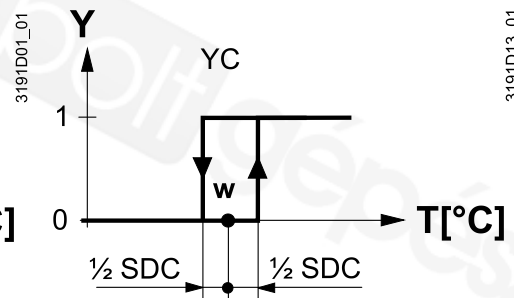

T[°C] Room temperature

w Room temperature setpoint

$X_{dz}$  Dead zone (P055)

YH Control command "Valve" (heating)

YC Control command "Valve" (cooling)

SDH Switching differential "Heating" (P051)

SDC Switching differential "Cooling" (P053)

**Modulating control:  
3-position, PWM, or  
DC 0...10 V**

The diagrams below show the control sequence of modulating PI control.

Heating and cooling mode (P001 = 4)

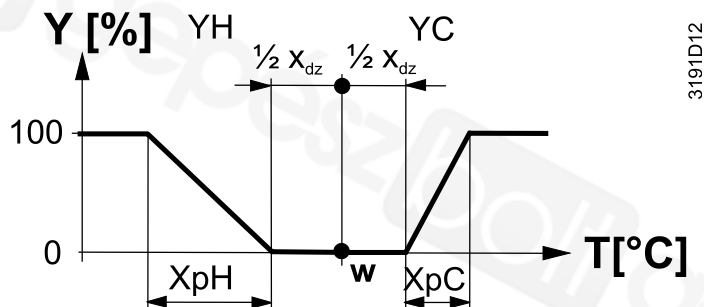

Heating mode with manual selection  
(P001 = 3) or  
for energy saving (P010 = 2 & P014) in  
heating sequence

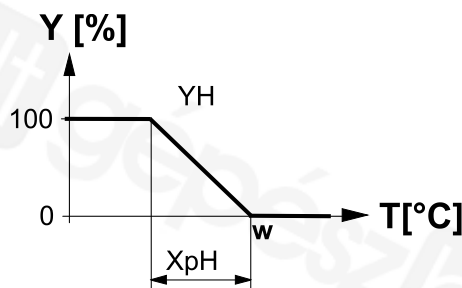

Cooling mode with manual selection  
(P001 = 3) or  
for energy saving (P010 = 2 & P015) in  
cooling sequence

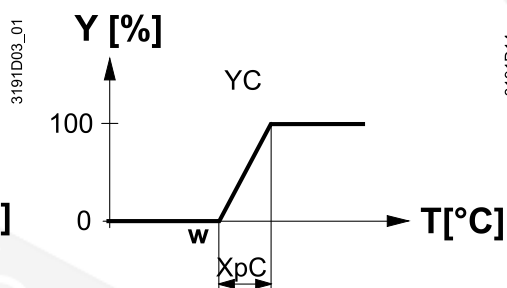

T[°C] Room temperature

w Room temperature setpoint

X<sub>dz</sub> Dead zone (P055)

YH Control command "Valve"  
(heating)

YC Control command "Valve"  
(cooling)

X<sub>pH</sub> Proportional band "Heating"  
(P050)

X<sub>pC</sub> Proportional band "Cooling"  
(P052)

**Note**

The diagrams only show the PI thermostat's proportional part.

For setting sequence and control outputs, see Application overview [→ 45],  
Sequence overview (setting via P001) [→ 87] and Control outputs [→ 124].

Parameter P256 (RDG264KN only), P260 & P261 (RDG26..) sets the  
heating/cooling flow limitation. See Additional functions [→ 53].

### 4.7.7.1 4-pipe application with one valve: 6-port ball valve or 6-port PICV (RDG26..)

RDG26.. can control a 6-port ball valve or 6-port PICV for fan coil applications.

- 4-pipe with 6-port ball valve (DIP4 = ON)
- 4-pipe with 6-port PICV (DIP2&4 = ON)

See Applications for universal systems [→ 47].

#### Principle

Only one DC signal (Y10 output) controls the 6-port valve / 6-port PICV.

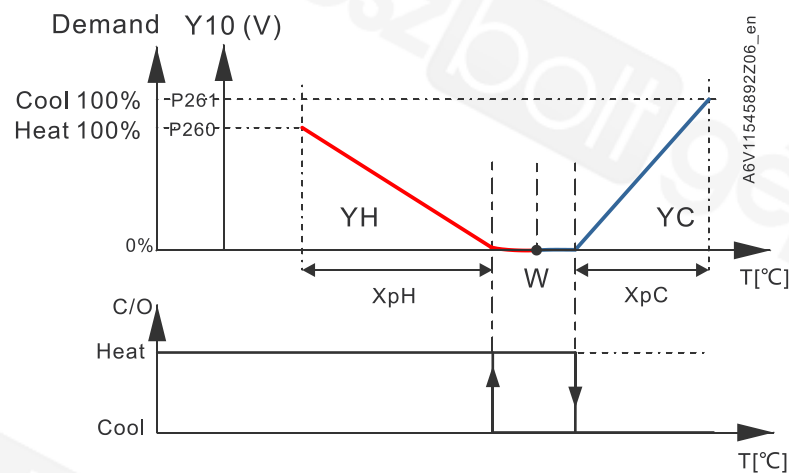
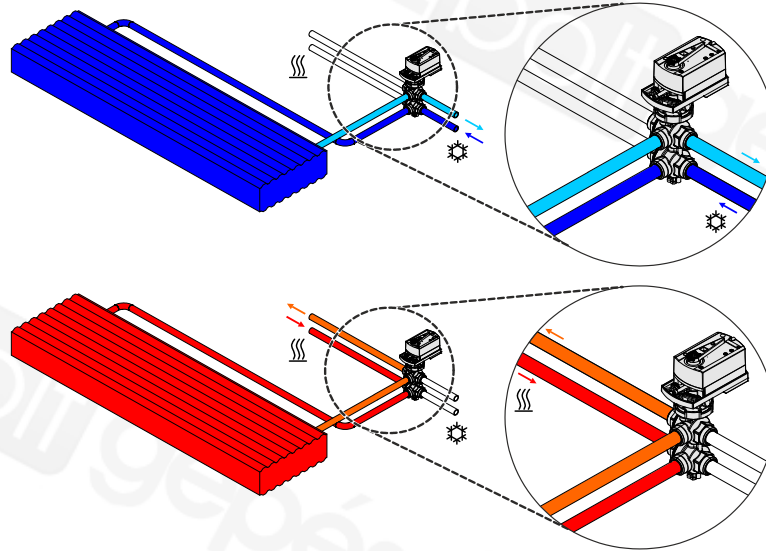

Hydraulic and control diagram of the 6-port PICV

- W Room temperature setpoint
- YH Control command "Valve" (heating)
- YC Control command "Valve" (cooling)
- Y10 DC 0...10 V signal
- T[°C] Room temperature
- P260 Flow limitation function for heating only
- P261 Flow limitation function for cooling only

Default integral action time  $T_N$  is set to 45 minutes.

#### Control output configuration

Output voltage range of Y10 can be configured via P201. For details, see Control output configuration for 6-port valve (P201) [→ 124].

### 4.7.7.2 4-pipe application with PICV and 6-port control ball valve as changeover (RDG26..)

In a 4-pipe fan coil application with DC 0...10 V fan control, the RDG26..KN controls a combi valve (PICV) in combination with a 6-port ball valve as changeover.

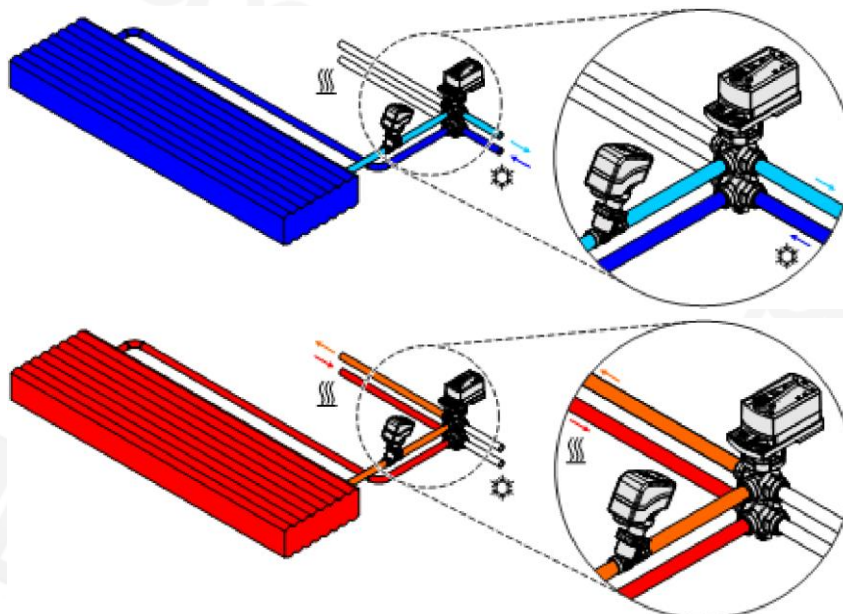

Note: Set DIP# 1 & 4 to ON (4-pipe with 6-port ball valve as changeover and PICV).

#### Principle

This application is used in 4-pipe systems with heat exchanger and differential pressure controller (using a PICV).

The changeover signal DC 0...10 V controls the flow rate in the PICV, while the 6-port ball valve, connected to the relay outputs, is used as changeover to switch the sequence between heating and cooling.

Enable the flow limitation function (for PICV) via parameter P256 (RDG264KN only), P260 & P261 to balance heating and cooling and avoid hydraulic problems caused by the different flow rates. (see Additional functions [→ 53]).

The fan can only be set on DC Y50 output in this application.

Set fan operation (P350) to enable (enable by default).

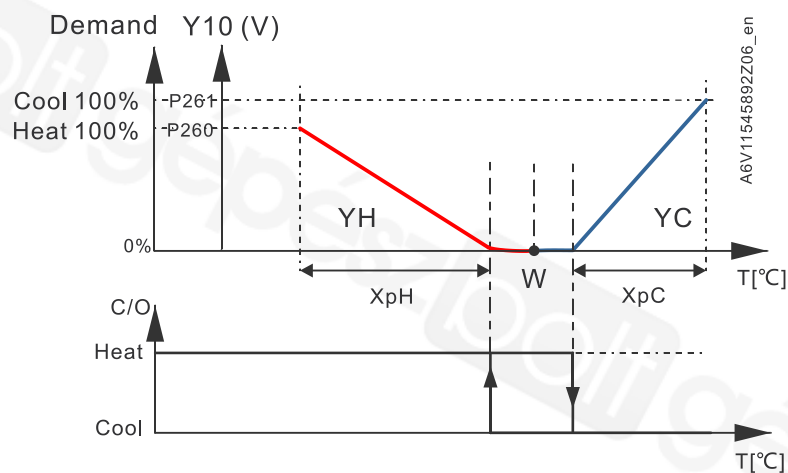

|                            |                                           |      |                                           |
|----------------------------|-------------------------------------------|------|-------------------------------------------|
| $T$ [ $^{\circ}\text{C}$ ] | Room temperature                          | Y10  | DC 0...10 V signal                        |
| W                          | Room temperature setpoint                 | YH   | Control command "Valve" (heating)         |
| YC                         | Control command "Valve" (cooling)         | P260 | Flow limitation function for heating only |
| P261                       | Flow limitation function for cooling only |      |                                           |

The connection diagram for 4-pipe applications with PICV and 6-port ball valve as changeover is available in Connection diagrams [ $\rightarrow$  189].



### 4.7.8 4-pipe fan coil unit with electric heater

**Heating and cooling with auxiliary heater**

In 4-pipe applications with electric heater, the thermostat controls 2 valves in heating and cooling mode by manual selection, heating only, or cooling only plus an auxiliary electric heater. Heating and cooling is factory-set (P001 = 4).

**Electric heating in heating mode**

The electric heater is used as an additional heat source when the heating energy controlled by the valve is insufficient.

The electric heater receives an On command, if the temperature is below "setpoint" minus "1/2 "dead zone" minus "setpoint differential" (= setpoint for electric heater).

**Digital input "Enable electric heater"**

Remote enabling/disabling of the electric heater is possible via input X1, X2, or U1 (RDG2..KN)/X3 (RDG2..T) for tariff regulations, energy saving, etc.

Input X1, X2, or U1/X3 must be commissioned accordingly (P150, P153 and P155). See Multifunctional input, digital input [→ 138].

The electric heater can also be enabled/disabled via bus. (RDG2..KN)



**Enable electric heater**

Do not assign the function to a local input X1, X2 or U1 if the bus input is used.

**⚠ CAUTION! The electric heater must always be protected by a safety limit thermostat!**

**4-pipe application with manual changeover**

The heating or cooling output can be released via operating mode button if P001 is set to Manual (P001 = 3).

**On/Off control**

The diagrams below show the control sequence for On/Off control.

Heating and cooling (P001 = 4)

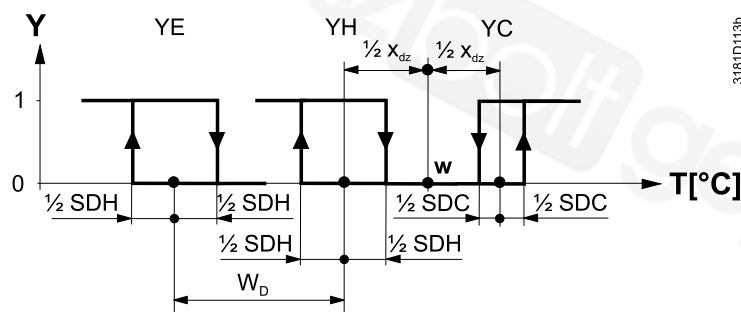

Heating mode with manual selection (P001 = 3)

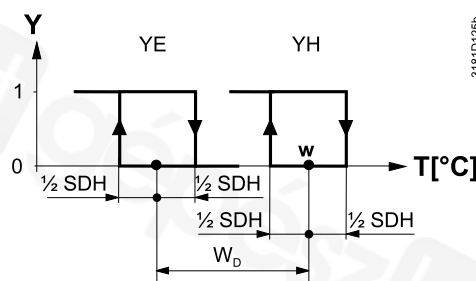

Cooling mode with manual selection (P001 = 3)

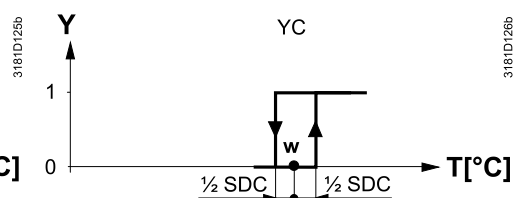

|                 |                              |     |                                         |
|-----------------|------------------------------|-----|-----------------------------------------|
| T [°C]          | Room temperature             | YE  | Control command "EI heater"             |
| w               | Room temperature setpoint    | YH  | Control command "Valve" (heating)       |
| X <sub>dz</sub> | Dead zone (P055)             | YC  | Control command "Valve" (cooling)       |
| w <sub>D</sub>  | Setpoint differential (P056) | SDH | Switching differential "Heating" (P051) |
|                 |                              | SDC | Switching differential "Cooling" (P053) |

**Modulating control:  
3-position or PWM**

The diagrams below show the control sequence for modulating PI control.

Heating and cooling (P001 = 4)

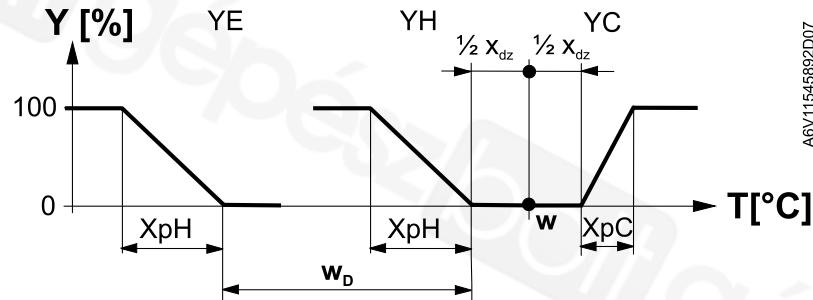

A6V11545892D07

Heating mode with manual selection  
(P001 = 3)

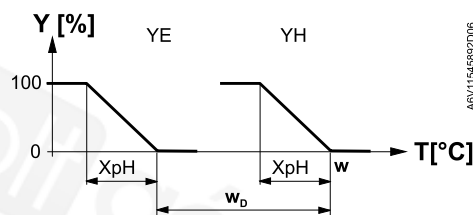

A6V11545892D06

Cooling mode with manual selection  
(P001 = 3)

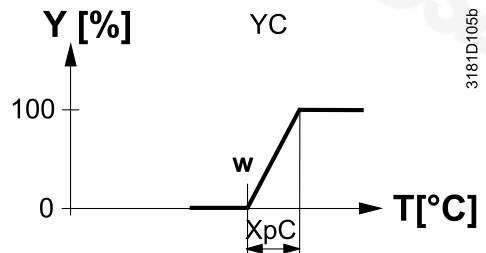

3181D105b

T[°C] Room temperature

w Room temperature setpoint

Xdz Dead zone (P055)

wD Setpoint differential  
(P056)

YE Control command "EI heater"

YH Control command  
"Valve" (heating)

YC Control command "Valve"  
(cooling)

XpH Proportional band  
"Heating" (P050)

XpC Proportional band "Cooling"  
(P052)

**Note**

The diagrams only show the PI thermostat's proportional part.

For setting sequence and control outputs, see Application overview [→ 45],

Sequence overview (setting via P001) [→ 87] and Control outputs [→ 124].

Parameter P256 (RDG264KN only), P260 & P261 (RDG26..KN) sets the heating flow limitation. See Additional functions [→ 53].

**Note**

- YH can only be DC, On/Off or PWM
- YC can be DC, On/Off, On/Off 3-wired, PWM or 3-position
- YE can only be DC, On/Off or PWM

## 4.7.9 Chilled/heated ceiling and radiator applications

For chilled/heated ceiling and radiator applications

- Set the corresponding basic application see Application overview [→ 45].
- Disable the fan (P350)

The following applications are available:

| Application for chilled/heated ceiling, radiator                                                                   | Basic application                                                        | Section                                                                                    | Sequences                                       |
|--------------------------------------------------------------------------------------------------------------------|--------------------------------------------------------------------------|--------------------------------------------------------------------------------------------|-------------------------------------------------|
| Chilled/heated ceiling with changeover                                                                             | 2-pipe                                                                   | 2-pipe fan coil unit [→ 90]                                                                | H ( \ )<br>C ( / )                              |
| Chilled/heated ceiling and electric heater (cooling only: disable electric heater via P027)                        | 2-pipe with electric heater                                              | 2-pipe fan coil unit with electric heater [→ 91]                                           | EI H + H ( \ \ )<br>EI H + C ( \ / )<br>C ( / ) |
| Chilled/heated ceiling and radiator                                                                                | 2-pipe with radiator                                                     | 2-pipe fan coil unit with radiator or floor heating [→ 93]                                 | H + rad ( \ r )<br>Rad + C ( r / )              |
| Chilled ceiling and radiator                                                                                       | 4-pipe                                                                   | 4-pipe fan coil unit [→ 100]                                                               | H + C ( \ / )                                   |
| Chilled/heated ceiling, 2-pipe/2-stage                                                                             | 2-pipe/2-stage heating or cooling                                        | 2-pipe/2-stage heating or cooling [→ 96]                                                   | H + H ( \ \ )<br>C + C ( / / )                  |
| Chilled/heated ceiling, 4-pipe/2-stage                                                                             | 4-pipe/2-stage heating and cooling                                       | 4-pipe/2-stage heating and cooling (RDG2..KN) [→ 98]                                       | H + C + H + C ( \ / \ / )                       |
| Chilled/heated ceiling with 6-port control ball valve or 6-port PICV                                               | 4-pipe application with one valve: 6-port ball valve or 6-port PICV      | 4-pipe application with one valve: 6-port ball valve or 6-port PICV (RDG26..) [→ 102]      | H + C ( \ / )                                   |
| Chilled/heated ceiling with pressure independent combi valve (PICV) and 6-port ball valve for changeover (RDG26..) | 4-pipe application with PICV and 6-port control ball valve as changeover | 4-pipe application with PICV and 6-port control ball valve as changeover (RDG26..) [→ 103] | H + C ( \ / )                                   |

### 4.7.10 Compressor applications

For compressor applications,

- Set the corresponding basic application as per Application overview [→ 45].
- Disable the fan (P350) or set the type of fan speed (P351)
- Select the type of control outputs (On/Off, P201, P203, P204, P205)

The following applications are available:

| Application for compressor in DX-type equipment                                            | Basic application           | Section                                          | Sequences                                         |
|--------------------------------------------------------------------------------------------|-----------------------------|--------------------------------------------------|---------------------------------------------------|
| 1-stage compressor                                                                         | 2-pipe                      | 2-pipe fan coil unit [→ 90]                      | H ( \ )<br>C ( / )                                |
| 1-stage compressor with reversing valve                                                    | 2-pipe                      | 2-pipe fan coil unit [→ 90]                      | H + C ( \ / )                                     |
| 1-stage compressor and electric heater<br>(cooling only: disable electric heater via P027) | 2-pipe with electric heater | 2-pipe fan coil unit with electric heater [→ 91] | El. H + H ( \ \ )<br>El. H + C ( \ / )<br>C ( / ) |
| 1-stage compressor for heating and cooling                                                 | 4-pipe                      | 4-pipe fan coil unit [→ 100]                     | H + C ( \ / )                                     |
| 2-stage compressor                                                                         | 2-stage heating or cooling  | 2-pipe/2-stage heating or cooling [→ 96]         | H + H ( \ / )<br>C + C ( / / )                    |

#### Note

|                              |                                                       |
|------------------------------|-------------------------------------------------------|
| Minimum On/Off time:         | P212/P213 (only with On/Off control outputs)          |
| Fan operation:               | P350 (0 = disabled, 1 = enabled)                      |
| Fan speed:                   | P351 (1 = 1-speed, 2 = 3-speed, 3 = DC 0...10 V)      |
| Control outputs On/Off:      | P201 = 4 (V1)    P203 = 4 (V2) (DC 0...10 V fan only) |
| Control outputs DC 0...10 V: | P201 = 5 (V1)    P203 = 5 (V2)                        |

### 4.7.11 Additional ventilation functions (IAQ + cooling with air)

Fresh air damper is controlled from RDG2..4KN to reduce the CO<sub>2</sub> concentration in the room during IAQ demand.

In addition, by enabling the "cooling with air" function via P450 (control strategy) = 5 or 6, the range of application can be extended to ventilation systems and cold air can be used to decrease the temperature.

The "cooling with air" function is available in fan coil, universal or VAV systems and works in all operating modes: Comfort, Economy and Protection.

For ventilation applications without IAQ control, RDG2..0KN can be used (see Cooling with air and IAQ control in ventilation systems [→ 114]).

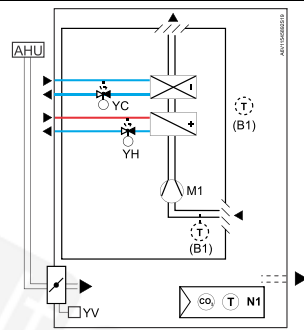
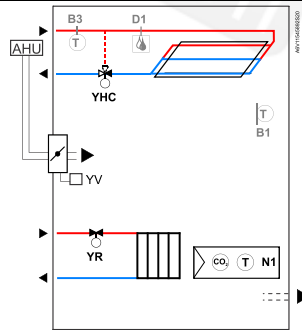
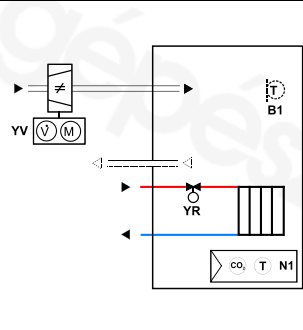
|                                                                                                                                                           |                                                                                                                                                                     |                                                                                             |
|-----------------------------------------------------------------------------------------------------------------------------------------------------------|---------------------------------------------------------------------------------------------------------------------------------------------------------------------|---------------------------------------------------------------------------------------------|
|                                                                          |                                                                                   |          |
| <p>IAQ only: CO<sub>2</sub> (IAQ) control in fan coil system [→ 110]</p> <p>IAQ and air cooling: Cooling with air and IAQ in fan coil systems [→ 111]</p> | <p>IAQ only: CO<sub>2</sub> (IAQ) control in universal H/C systems [→ 112]</p> <p>IAQ and air cooling: Cooling with air and IAQ in universal H/C system [→ 113]</p> | <p>IAQ and air cooling: Cooling with air and IAQ control in ventilation systems [→ 114]</p> |

"Cooling with air" is supported by RDG204KN.. and RDG264KN...

Cold air (e.g., 16...18 °C) must be provided from an external ventilation system (e.g., AHU). Thermostat does not measure nor supervise the supply air temperature.

Air cooling function does not support the manager/subordinate configuration.



Min./max. damper position [%] (P455, P457)

Minimum and maximum damper position can be adjusted via KNX S-Mode objects 108, 109.

### 4.7.11.1 CO<sub>2</sub> (IAQ) control in fan coil system

For fan coil systems with DC or 3-speed fan, RDG204KN.. or RDG264KN controls the damper position and provides fresh air in the room to reduce the CO<sub>2</sub> concentration.

For all 2-/4-pipe fan coil applications (Applications for fan coil systems [→ 46]), the IAQ function can be enabled by selecting the strategy control: P450 = 2 (default: temperature + indoor air quality) or P450 = 3 (temperature, humidity, indoor air quality).

Outside air or treated air from a ventilation system (e.g., AHU) can be supplied in the room.

Thermostat supports fan coil equipment with built-in fresh air damper (use cases a and b), or equipment acquired air from an independent ventilation system.

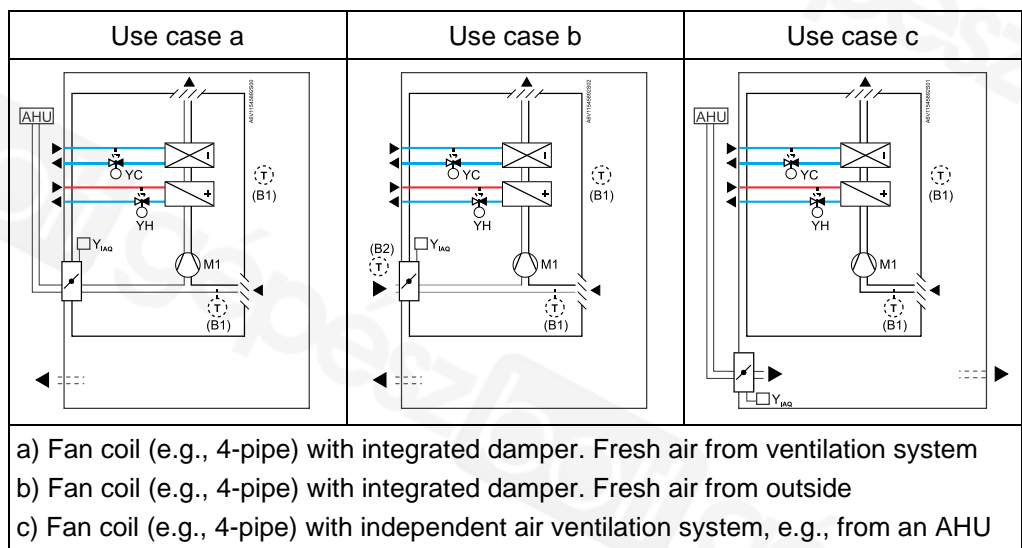

IAQ can be controlled by

- Driving a DC damper (P453 = 1)
- Opening an On/Off damper and controlling the fan (P453 = 2 or 3)
- Opening firstly the DC damper, and in the 2<sup>nd</sup> stage, controlling the fan speed (P453 = 1 and P450 = 4)

For system optimization and control performance improvement, evaluate if following parameters need to be enabled or adjusted:

- IAQ setpoint (P023) and IAQ P-band (P454, P456)
- Run fan during IAQ control (P458), especially for equipment with built-in fresh air damper
- Minimal/maximal damper position (P455, P457)
- Outside damper frost protection (P109)

### 4.7.11.2 Cooling with air and IAQ in fan coil systems

For fan coil systems with DC or 3-speed fan, RDG204KN.. or RDG264KN.. controls the damper position and provides fresh air in the room, to reduce the CO<sub>2</sub> concentration and cool the temperature.

The DC 0...10 V control signal to the fresh air damper (U1 output on RDG) is driven by the higher value between cooling demand and IAQ demand. Damper control signal On/Off is not supported.

By enabling the "Cooling with air" function (P450), when the fan coil runs in cooling mode, the cooling demand is also used to control the fresh air damper.

Cold air (e.g., 16...18 °C) must be treated and acquired from an external ventilation system (e.g., AHU). Thermostat does not measure nor supervise the supply air temperature.

Supported applications:

|  |                                                                                |
|--|--------------------------------------------------------------------------------|
|  | 2-pipe fan coil unit, cooling only (P001 = 1, 2, 3)                            |
|  | 2-pipe fan coil unit cooling only (P001 = 1, 2, 3), with electric heater       |
|  | 2-pipe fan coil unit cooling only (P001 = 1, 2, 3) with radiator/floor heating |
|  | 4-pipe fan coil unit (P001 = 3 or 4 (default))                                 |
|  | 4-pipe fan coil unit with 6-port PICV (P001 = 4) <sup>1)</sup>                 |
|  | 4-pipe fan coil unit with 6-port ball valve (P001 = 4) <sup>1)</sup>           |

1) Application available on RDG264KN only

After application selected, enable the "Cooling with air" function by selecting the control strategy: P450 = 5 (temperature, air quality, air cooling) or P450 = 6 (temperature, air quality, air cooling in 2nd stage).

Cooling with air in parallel to the water system (P450 = 5)

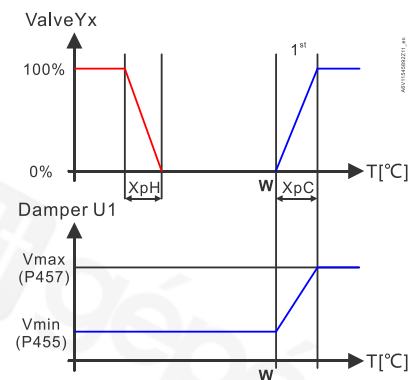

Cooling with air in 2<sup>nd</sup> stage (P450 = 6)

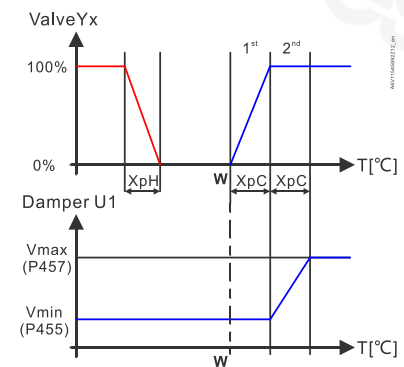

T[°C] Room temperature  
w Room temperature setpoint  
XpH Proportional band "Heating" (P050)

XpC Proportional band "Cooling" (P052)  
Vmax Maximum damper position (P457)  
Vmin Minimum damper position (P455)

Following control signals are available for the equipment:

- RDG204KN: PWM, 3-position  
Note: It is recommended to set PWM algorithm P206...P209 to 1200 sec = 20 min.
- RDG264KN: DC 0...10 V

The "cooling with air" function does not support control output signal on/off. Parameters P201/P203 for setting output need to be set accordingly.

For system optimization and control performance improvement, evaluate if the following parameters need to be enabled or adjusted:

- IAQ setpoint (P023) and IAQ P-band (P454, P456)
- Run fan during IAQ control (P458), especially for equipment with built-in fresh air damper
- Minimal/maximal damper position (P455, P457)

#### Notes

- Applications with 2-stages are not supported.

### 4.7.11.3 CO<sub>2</sub> (IAQ) control in universal H/C systems

For universal heating/cooling systems, RDG204KN.. or RDG264KN controls the damper of an independent air ventilation and provides fresh air in the room to reduce the CO<sub>2</sub> concentration, in case of IAQ demand.

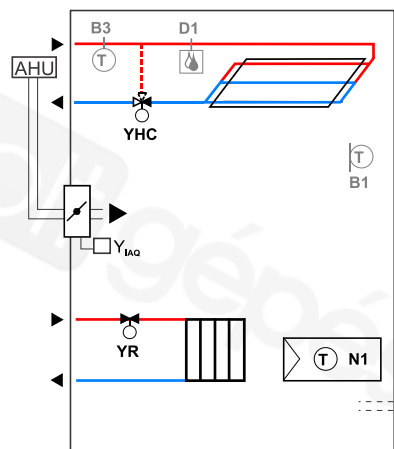

Select basic (fan coil) application as per Chilled/heated ceiling and radiator applications [→ 46] and disable fan function (P350 = 0).

For system optimization and control performance improvement, evaluate if the following parameters need to be enabled or adjusted:

- IAQ setpoint (P023) and IAQ P-band (P454, P456)
- Minimal/maximal damper position (P455, P457)



### 4.7.11.4 Cooling with air and IAQ in universal H/C system

For universal heating/cooling systems, RDG204KN.. or RDG264KN.. controls the damper position and provides fresh air in the room, to reduce the CO<sub>2</sub> concentration and cool the room temperature.

The DC 0...10 V control signal to the fresh air damper (U1 output on RDG) is driven by the higher value between cooling demand and IAQ demand. Damper control signal ON/OFF is not supported.

By enabling the "Cooling with air" function (P450), when the H/C system runs in cooling mode, the cooling demand is also used to control the fresh air damper.

Cold air (e.g., 16...18 °C) must be treated and acquired from an external ventilation system (e.g., AHU). Thermostat does not measure nor supervise the supply air temperature.

Supported applications:

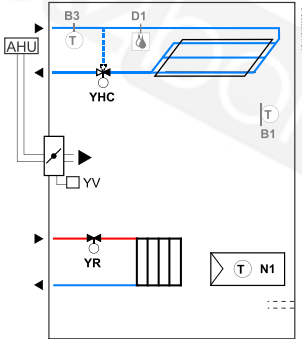
|  | Universal H/C cooling application                                        | Basic application to be selected              |
|------------------------------------------------------------------------------------|--------------------------------------------------------------------------|-----------------------------------------------|
|                                                                                    | Chilled ceiling                                                          | 2-pipe fan coil unit, cooling only (P001 = 1) |
| Chilled ceiling and el. heater                                                     | 2-pipe fan coil unit cooling only (P001 = 1), with electric heater       |                                               |
| Chilled ceiling and radiator/floor heating                                         | 2-pipe fan coil unit cooling only (P001 = 1) with radiator/floor heating |                                               |
| Chilled ceiling and radiator                                                       | 4-pipe fan coil unit (P001 = 3 or 4 (default))                           |                                               |
| Chilled and heated ceiling control with 6-port ball valve <sup>1)</sup>            | 4-pipe fan coil unit with 6-port PICV (P001 = 4)                         |                                               |
| Chilled and heated ceiling control with 6-port PICV <sup>1)</sup>                  | 4-pipe fan coil unit with 6-port ball valve (P001 = 4)                   |                                               |

1) Application available on RDG264KN only

|                                                                                     |                                                                            |
|-------------------------------------------------------------------------------------|----------------------------------------------------------------------------|
|  | <b>CAUTION</b>                                                             |
|                                                                                     | The electric heater must always be protected by a safety limit thermostat! |

After basic (fan coil) application selection, disable the fan function (P350 = 0) and enable the "Cooling with air" function by selecting P450 = 5 (temperature, air quality, air cooling) or P450 = 6 (temperature, air quality, air cooling in the 2<sup>nd</sup> stage)

Cooling with air in parallel to the water system (P450=5)

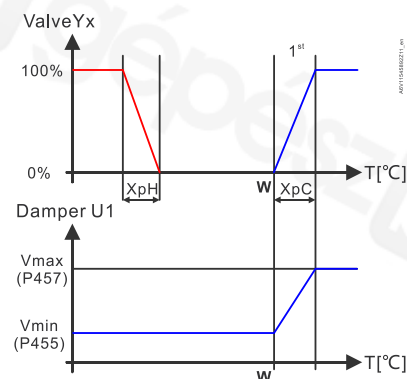

T[°C] Room temperature  
w Room temperature setpoint  
XpH Proportional band "Heating" (P050)

Cooling with air in 2<sup>nd</sup> stage (P450=6)

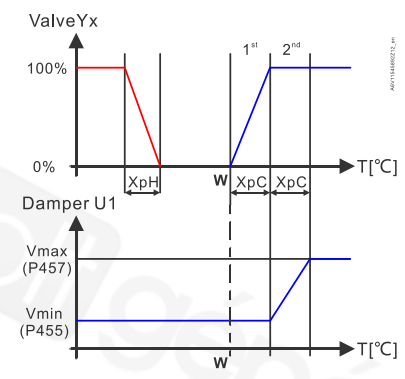

XpC Proportional band "Cooling" (P052)  
Vmax Maximum damper position (P457)  
Vmin Minimum damper position (P455)

Following control signals are available for the equipment:

- RDG204KN: PWM, 3-position  
Note: It is recommended to set PWM algorithm P206...P209 to 2700 sec = 45 min for controlling valves.
- RDG264KN: DC 0...10 V

#### Note

The air cooling does not support on/off control output signal. Output parameters P201 / P203 need to be set accordingly.

For system optimization and control performance improvement, evaluate if the following parameters need to be enabled or adjusted:

- IAQ setpoint (P023) and IAQ P-band (P454, P456)
- Minimal/maximal damper position (P455, P457)

#### «Nordic» application

Universal heating / cooling application for "EU Nordic countries":

Thermostats can be set to control the chilled ceiling and floor heating. Fresh air is provided for IAQ control and cooling the temperature in the room ("cooling with air" supports chilled ceiling) during cooling demand. See Ventilation air cooling (RDG2..KN) [→ 203], example 2.

### 4.7.11.5 Cooling with air and IAQ control in ventilation systems

For ventilation systems, if there is a request to decrease the temperature in the room by providing fresh air, RDG2..0KN can be used to control the fresh air damper. Simultaneously, there is also a need to reduce the CO<sub>2</sub> concentration in the room (IAQ control), RDG204KN or RDG264KN can be used.

On RDG2..4KN, the DC 0...10 V control signal to the fresh air damper is driven by the higher value between cooling demand and IAQ demand.  
Damper control signal On/Off is not supported.

Cold air (e.g., 16...18 °C) must be treated and acquired from an external ventilation system (e.g., AHU). The condition for the correct operation is that the air temperature is colder than the room temperature.

As the thermostat does not measure nor supervise the supply air temperature, heating the room temperature with warm air is not support.

Supported applications:

- Single duct (cooling only) and IAQ control, see Single duct (cooling only) application and IAQ control [→ 115]
- Single duct (cooling only) and radiator/floor heating and IAQ control, see Single duct (cooling only) application with IAQ control and radiator / floor heating [→ 116]
- Single duct air cooling only, with electric heater and IAQ control, see Single duct (cooling only) application with IAQ control and electric heater [→ 118]

Applications with RDG2..4KN:

For system optimization and control performance improvement, evaluate if the following functions need to be enabled or adjusted:

- IAQ setpoint (P023) and IAQ P-band (P454, P456)
- Minimal/maximal damper position (P455, P457)

Applications with RDG2..0KN:

Evaluate if the following functions need to be adjusted for the optimal user operation:

- Lock fan button function for end user on HMI, P028 (keypad) = 5
- End user can select auto ventilation auto or off, P003 = 3 (Auto - Protection)

### 4.7.11.5.1 Single duct (cooling only) application and IAQ control

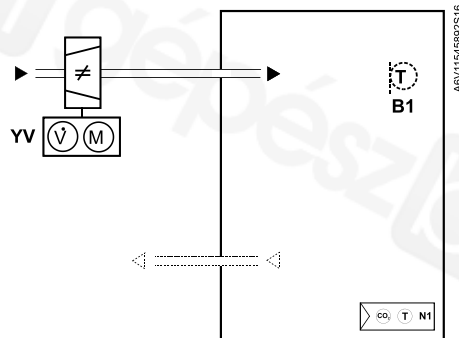

Two options are available for controlling the fresh air damper:

- RDG2..0KN: To decrease the temperature in the room. Damper is connected to the Y50 output.
- RDG2..4KN: To decrease the temperature in the room and reduce the CO<sub>2</sub> concentration / IAQ control. Damper is connected to the U1 output.

On single-duct applications, the thermostat controls an actuator (air damper, VAV system, etc.) in cooling mode only (factory-set P001 = 1).

Setting basic application 2-pipe fan coil unit [→ 90]

| RDG204KN.. / RDG264KN..                                                                                                                           |                           | RDG2..0KN..                                                                                                    |                                        |
|---------------------------------------------------------------------------------------------------------------------------------------------------|---------------------------|----------------------------------------------------------------------------------------------------------------|----------------------------------------|
| Cooling with air and IAQ control                                                                                                                  |                           | Cooling with air only                                                                                          |                                        |
| Damper actuator is connected to the output U1 on RDG and controlled by the modulating DC 0...10 V signal.                                         |                           | Damper actuator is connected to the fan output Y50 on RDG and controlled by the modulating DC 0...10 V signal. |                                        |
| "Cooling with air" function should be enabled (P450 = 5, temperature, air quality, air cooling) and fan functions need to be disabled (P350 = 0). |                           | Select fan speed DC 0...10 V, P351 = 3                                                                         |                                        |
| The output signal for the air flow can be limited to a minimum (P455) and maximum (P457) value if required.                                       |                           | The output signal for the air flow can be limited to a minimum and maximum value if required. (P357, P360)     |                                        |
| Proportional band "Cooling" (P052)<br>Proportional band "IAQ" (P454)                                                                              |                           | Proportional band "Cooling" (P052)                                                                             |                                        |
| Modulation control DC 0...10 V for damper:                                                                                                        |                           |                                                                                                                |                                        |
|                                                                                                                                                   |                           |                                                                                                                |                                        |
| Vmax                                                                                                                                              | Max. ventilation, P457    | Vmax.                                                                                                          | Max. ventilation in cooling mode, P360 |
| Vmin                                                                                                                                              | Min. ventilation, P455    | Vmin.                                                                                                          | Min. ventilation, P357                 |
| w                                                                                                                                                 | Room temperature setpoint |                                                                                                                |                                        |

|     |                                                                      |
|-----|----------------------------------------------------------------------|
| YV  | Control command VAV-box/damper                                       |
| XpC | Proportional band "Cooling" (P052)<br>Proportional band "IAQ" (P454) |

Vmin / Vmax values must be provided from planner (depends on the air balancing or parameter setting of VAV controller).

Recommendations for applications with RDG2..0KN:

- Switching point, P356 = 1 %
- Minimum ventilation, P357 = 30 %
- Set Vmin in dead zone in Comfort mode, P029 = 1
- Enable ventilation Vmin in dead zone in ECO mode, P364 (Periodic fan kick Economy) = 0
- Because the DC fan output signal on terminal Y50 controls the damper position, we do not recommend enabling following functions:
  - Fan overrun time (setting P352 = 0)
  - Fan start delay (setting P365 = 0)

#### 4.7.11.5.2 Single duct (cooling only) application with IAQ control and radiator / floor heating

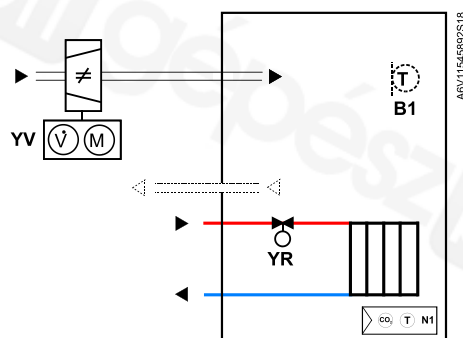

Two options are available for controlling the fresh air damper:

- RDG2..0KN: To decrease the temperature in the room. Damper is connected to the Y50 output.
- RDG2..4KN: To decrease the temperature in the room and reduce the CO<sub>2</sub> concentration / IAQ control. Damper is connected to the U1 output.

On single-duct applications with radiator or floor heating, the thermostat controls an actuator (air damper, VAV system, etc.) and the radiator valve actuator.

Setting basic application 2-pipe fan coil unit with radiator or floor heating [→ 93], with P001 =1, set to cooling only

| RDG204KN.. / RDG264KN..                                                                                                                           | RDG2..0KN..                                                                                                    |
|---------------------------------------------------------------------------------------------------------------------------------------------------|----------------------------------------------------------------------------------------------------------------|
| Air cooling and IAQ control                                                                                                                       | Air cooling only                                                                                               |
| Damper actuator is connected to the output U1 on RDG and controlled by the modulating DC 0...10 V signal.                                         | Damper actuator is connected to the fan output Y50 on RDG and controlled by the modulating DC 0...10 V signal. |
| "Cooling with air" function should be enabled (P450 = 5, temperature, air quality, air cooling) and fan functions need to be disabled (P350 = 0). | Select fan speed DC 0...10 V, P351 = 3                                                                         |
| The output signal for the air flow can be limited to a minimum (P455) and maximum (P457) value if required.                                       | The output signal for the air flow can be limited to a minimum and maximum value if required. (P357, P360)     |

|                                                                                                                                                                      |                                                                      |                                                                                                                                   |                                        |
|----------------------------------------------------------------------------------------------------------------------------------------------------------------------|----------------------------------------------------------------------|-----------------------------------------------------------------------------------------------------------------------------------|----------------------------------------|
| Proportional band "Cooling" (P052)<br>Proportional band "IAQ" (P454)                                                                                                 |                                                                      | Proportional band "Cooling" (P052)                                                                                                |                                        |
| The radiator is connected on Y20/Y2 and controlled by the modulating DC 0...10 V (RDG264KN..) or PWM/3-pos (RDG204KN) signal. Control signal on/off is not supported |                                                                      | The radiator is connected on Y20/Y2 and controlled by the modulating DC 0...10 V (RDG260KN..) or On/Off, PWM, 3-pos (RDG200KN..). |                                        |
| Modulation control DC 0...10 V for damper:                                                                                                                           |                                                                      |                                                                                                                                   |                                        |
|                                                                                                                                                                      |                                                                      |                                                                                                                                   |                                        |
| Vmax                                                                                                                                                                 | Max. ventilation, P457                                               | Vmax.                                                                                                                             | Max. ventilation in cooling mode, P360 |
| Vmin                                                                                                                                                                 | Min. ventilation, P455                                               | Vmin.                                                                                                                             | Min. ventilation, P357                 |
| w                                                                                                                                                                    | Room temperature setpoint                                            |                                                                                                                                   |                                        |
| YV                                                                                                                                                                   | Control command VAV-box/damper                                       |                                                                                                                                   |                                        |
| XpC                                                                                                                                                                  | Proportional band "Cooling" (P052)<br>Proportional band "IAQ" (P454) |                                                                                                                                   |                                        |
| XpH                                                                                                                                                                  | Proportional band "Heating" (P050)                                   |                                                                                                                                   |                                        |
| Xdz                                                                                                                                                                  | Dead zone (P055)                                                     |                                                                                                                                   |                                        |
| YR                                                                                                                                                                   | Control command "Radiator"                                           |                                                                                                                                   |                                        |

Vmin / Vmax values must be provided from planner (depends on the air balancing or parameter setting of VAV controller)

Following control signals are available for radiator:

- RDG204KN: PWM, 3-position  
RDG200KN: On/Off, PWM, 3-position  
Note: It is recommended to set PWM algorithm P206...P209 to 2700 sec = 45 min
- RDG26...KN: DC 0...10 V

**Note**

The air cooling on RDG2..4KN does not support control output signal on/off. Output parameter P201 / P203 needs to be set accordingly.

Recommendations for the applications with RDG2..0KN:

- Switching point, P356 = 1 %
- Set Vmin in dead zone in Comfort mode, P029 =1
- If ventilation should run in operating mode ECO, Vmin = P364 (Periodic fan kick Economy) should be set to 0.
- Because the DC fan output signal on terminal Y50 controls the damper position, we do not recommend enabling following functions:
  - Fan overrun time (setting P352 = 0)
  - Fan start delay (setting P365 = 0)

Radiator, active in cooling mode

The thermostat increases the air flow when the room temperature exceeds the setpoint for cooling.  
When the acquired room temperature drops below the heating setpoint (= setpoint for radiator), the thermostat release the heating sequence.

Floor heating

The radiator sequence can also be used for floor heating.  
The "Floor temperature limitation" function is described on Monitoring and limiting functions [→ 59].

#### 4.7.11.5.3 Single duct (cooling only) application with IAQ control and electric heater

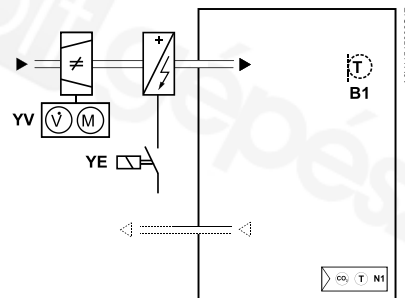

Two options are available for controlling the fresh air damper:

- RDG2..0KN: To decrease the temperature in the room. Damper is connected to the Y50 output.
- RDG2..4KN: To decrease the temperature in the room and reduce the CO<sub>2</sub> concentration / IAQ control. Damper is connected to the U1 output.

#### Caution

General rule: In case of insufficient air flow, the thermostat cannot protect the electric heater against overtemperature. For this reason, the heater **must** be equipped with a separate safety device (thermal cutout).

On single-duct applications with electric heater, the thermostat controls an actuator (air damper, VAV system, valve, etc.) and an electric heater.

Setting basic application 2-pipe fan coil unit with electric heater [→ 91] with P001 = 1, set to cooling only.

| RDG204KN.. / RDG264KN..                                                                                                                                                                                                                                                                                                                                                                                                                                                                                                                                                                                                                                                                                                                                                                                                                 |                                | RDG2..0KN..                                                                                                                                                                                                                                                                                                                                                                                                                                                                                                                                                                                                                                                                                                                                                                                                                 |                                        |
|-----------------------------------------------------------------------------------------------------------------------------------------------------------------------------------------------------------------------------------------------------------------------------------------------------------------------------------------------------------------------------------------------------------------------------------------------------------------------------------------------------------------------------------------------------------------------------------------------------------------------------------------------------------------------------------------------------------------------------------------------------------------------------------------------------------------------------------------|--------------------------------|-----------------------------------------------------------------------------------------------------------------------------------------------------------------------------------------------------------------------------------------------------------------------------------------------------------------------------------------------------------------------------------------------------------------------------------------------------------------------------------------------------------------------------------------------------------------------------------------------------------------------------------------------------------------------------------------------------------------------------------------------------------------------------------------------------------------------------|----------------------------------------|
| Air cooling and IAQ control                                                                                                                                                                                                                                                                                                                                                                                                                                                                                                                                                                                                                                                                                                                                                                                                             |                                | Air cooling only                                                                                                                                                                                                                                                                                                                                                                                                                                                                                                                                                                                                                                                                                                                                                                                                            |                                        |
| Damper actuator is connected to the output U1 on RDG and controlled by the modulating DC 0...10 V signal.                                                                                                                                                                                                                                                                                                                                                                                                                                                                                                                                                                                                                                                                                                                               |                                | DC 0...10 V damper actuator is connected to the fan output Y50 on RDG.                                                                                                                                                                                                                                                                                                                                                                                                                                                                                                                                                                                                                                                                                                                                                      |                                        |
| "Cooling with air" function should be enabled (P450 = 5, temperature, air quality, air cooling) and fan functions need to be disabled (P350 = 0).                                                                                                                                                                                                                                                                                                                                                                                                                                                                                                                                                                                                                                                                                       |                                | Select fan speed DC 0...10 V, P351 = 3                                                                                                                                                                                                                                                                                                                                                                                                                                                                                                                                                                                                                                                                                                                                                                                      |                                        |
| The output signal for the air flow can be limited to a minimum (P455) and maximum (P457) value if required.                                                                                                                                                                                                                                                                                                                                                                                                                                                                                                                                                                                                                                                                                                                             |                                | The output signal for the air flow can be limited to a minimum (P357) and maximum (P360, P359) value if required                                                                                                                                                                                                                                                                                                                                                                                                                                                                                                                                                                                                                                                                                                            |                                        |
| while the electric heater is in operation, the ventilation remains constant at minimum ventilation (P455). Make sure that the setting of Vmin guarantee sufficient air flow for avoiding overheating of the system.                                                                                                                                                                                                                                                                                                                                                                                                                                                                                                                                                                                                                     |                                | While the electric heater is in operation, the ventilation is controlled between the maximum ventilation for heating P359 and the medium ventilation P358.                                                                                                                                                                                                                                                                                                                                                                                                                                                                                                                                                                                                                                                                  |                                        |
| Proportional band "Cooling" (P052)<br>Proportional band "IAQ" (P454)                                                                                                                                                                                                                                                                                                                                                                                                                                                                                                                                                                                                                                                                                                                                                                    |                                | Proportional band "Cooling" (P052)                                                                                                                                                                                                                                                                                                                                                                                                                                                                                                                                                                                                                                                                                                                                                                                          |                                        |
| Electric heater is connected on Y20/Y2 and controlled by the modulating DC 0...10 V (RDG264KN..) or PWM (RDG204KN) signal. Control signal on/off is not supported                                                                                                                                                                                                                                                                                                                                                                                                                                                                                                                                                                                                                                                                       |                                | Electric heater is connected on Y20/Y2 and controlled by the modulating DC 0...10 V (RDG260KN..) or On/Off, PWM, 3-pos (RDG200KN..).                                                                                                                                                                                                                                                                                                                                                                                                                                                                                                                                                                                                                                                                                        |                                        |
| Modulation control DC 0...10 V for damper:                                                                                                                                                                                                                                                                                                                                                                                                                                                                                                                                                                                                                                                                                                                                                                                              |                                |                                                                                                                                                                                                                                                                                                                                                                                                                                                                                                                                                                                                                                                                                                                                                                                                                             |                                        |
| <p>The graph shows the damper modulation control for RDG204KN.. / RDG264KN.. The vertical axis is labeled 'Y' and ranges from 0% to 100%. The horizontal axis is labeled 'TR[°C]'. A red line represents the damper modulation signal. It starts at a minimum ventilation level (Vmin) and remains constant until a room temperature setpoint (w) is reached. At this point, the signal increases linearly to a maximum ventilation level (Vmax) at a temperature (XpC). The proportional band for cooling is indicated as XpC. The maximum ventilation level is limited to Vmax. The minimum ventilation level is limited to Vmin. The damper modulation signal is labeled YV. The room temperature setpoint is labeled w. The room temperature range for heating is labeled Xdz. The damper modulation signal is also labeled YE.</p> |                                | <p>The graph shows the damper modulation control for RDG2..0KN.. The vertical axis is labeled 'Y' and ranges from 0% to 100%. The horizontal axis is labeled 'TR[°C]'. A red line represents the damper modulation signal. It starts at a maximum ventilation level (Vmax) and remains constant until a room temperature setpoint (w) is reached. At this point, the signal decreases linearly to a minimum ventilation level (Vmin) at a temperature (XpH). The proportional band for heating is indicated as XpH. The minimum ventilation level is limited to Vmin. The maximum ventilation level is limited to Vmax. The damper modulation signal is labeled YV. The room temperature setpoint is labeled w. The room temperature range for heating is labeled Xdz. The damper modulation signal is also labeled YE.</p> |                                        |
| Vmax                                                                                                                                                                                                                                                                                                                                                                                                                                                                                                                                                                                                                                                                                                                                                                                                                                    | Max. ventilation, P457         | Vmax.                                                                                                                                                                                                                                                                                                                                                                                                                                                                                                                                                                                                                                                                                                                                                                                                                       | Max. ventilation in cooling mode, P360 |
| Vmin                                                                                                                                                                                                                                                                                                                                                                                                                                                                                                                                                                                                                                                                                                                                                                                                                                    | Min. ventilation, P455         | Vmin.                                                                                                                                                                                                                                                                                                                                                                                                                                                                                                                                                                                                                                                                                                                                                                                                                       | Min. ventilation, P357                 |
| Vmed                                                                                                                                                                                                                                                                                                                                                                                                                                                                                                                                                                                                                                                                                                                                                                                                                                    | Med. ventilation, P358         | Vmax                                                                                                                                                                                                                                                                                                                                                                                                                                                                                                                                                                                                                                                                                                                                                                                                                        | For heating, P359                      |
| w                                                                                                                                                                                                                                                                                                                                                                                                                                                                                                                                                                                                                                                                                                                                                                                                                                       | Room temperature setpoint      |                                                                                                                                                                                                                                                                                                                                                                                                                                                                                                                                                                                                                                                                                                                                                                                                                             |                                        |
| YV                                                                                                                                                                                                                                                                                                                                                                                                                                                                                                                                                                                                                                                                                                                                                                                                                                      | Control command VAV-box/damper |                                                                                                                                                                                                                                                                                                                                                                                                                                                                                                                                                                                                                                                                                                                                                                                                                             |                                        |

|     |                                                                      |
|-----|----------------------------------------------------------------------|
| XpC | Proportional band "Cooling" (P052)<br>Proportional band "IAQ" (P454) |
| XpH | Proportional band "Heating" (P050)                                   |
| Xdz | Dead zone (P055)                                                     |
| YE  | Control command "Electric heater"                                    |

Vmin / Vmax values must be provided from planner (depends on the air balancing or parameter setting of VAV controller), for avoiding overheating, while the electric heater operates.

Following control signals are available for electric heater:

- RDG204KN: PWM, 3-position  
RDG200KN: On/Off, PWM, 3-position  
Note: It is recommended to set PWM algorithm P206...P209 to 1200 sec = 20 min
- RDG26...KN: DC 0...10 V

#### Note

The air cooling on RDG2..4KN does not support control output signal on/off. Output parameter P201 / P203 needs to be set accordingly.

Electric heating,  
active in cooling mode

The air flow starts to rise depending on the acquired room temperature and the setpoint.

The electric heater is enabled, when the acquired room temperature drops below the setpoint heating (= setpoint for electric heater).

Digital input "Enable electric heater"

Remote enabling/disabling of the electric heater is possible via input X1, X2 for tariff regulations, energy savings, etc.  
Multifunctional Input X1/X2 must be commissioned accordingly (P150, P153) (see Multifunctional input, digital input [→ 138]).

Enable electric heater

The electric heater can also be enabled/disabled via bus.

Note

If input "Enable electric heater" is used via bus, the function **must not** be assigned to a local multifunctional input X1, X2.

Fan overrun time

To avoid overheating of an electric heater when switched off, the air flow signal of Vmin must be maintained and ensured by the primary controller (e.g. AHU).

Recommendations for the applications with RDG2..0KN:

- Switching point, P356 = 1 %
- Set Vmin in dead zone in Comfort mode, P029 = 1, P357 = 50 %
- If ventilation should run in operating mode ECO, Vmin = P364 (Periodic fan kick Economy) should be set to 0.
- Because the DC fan output signal on terminal Y50 controls the damper position, we do not recommend enabling following functions:
  - Fan overrun time (set P352 = 0)
  - Fan start delay (set P365 = 0)



### 4.7.12 Applications with external AQR sensor or QMX room operator unit (RDG2..KN)

The equipment combination is intended for commercial buildings, offices, schools, museums, shops, etc.

| Advantages of equipment combination |                                                                                                                                                                                                                       | AQR/QMX sensor |        |
|-------------------------------------|-----------------------------------------------------------------------------------------------------------------------------------------------------------------------------------------------------------------------|----------------|--------|
|                                     |                                                                                                                                                                                                                       | LTE-Mode       | S-Mode |
| a)                                  | Sensor can be installed in the optimal place for temperature and humidity measurement.                                                                                                                                | ✓              | ✓      |
| b)                                  | Unauthorized persons cannot change settings on sensors installed in the room.                                                                                                                                         | ✓              | ✓      |
| c)                                  | HVAC equipment and measuring point (T, r.h.) are far apart (in large spaces). Installing the thermostat near the equipment and the sensor on the measuring point reduces wiring costs and increases control accuracy. | ✓              | ✓      |
| d)                                  | Several RDG2..KN room thermostats can operate with one room temperature and/or humidity value (in large spaces).                                                                                                      | ×              | ✓      |
| e)                                  | AQR/QMX sensor is better suited to interior designs.                                                                                                                                                                  | ✓              | ✓      |

**With sensor  
AQR25.. or QMX3..0**

Sensor AQR25..., QMX3.P30 or QMX3.P70 supplies relative humidity and room temperature values to the RDG2..KN.

RDG2..KN and the sensors use LTE-Mode (KNX) communication. To exchange information (humidity or room temperature), both units must have the same geographic zone apartment and room (A.R.1, where "A" is the value of P901 and "R" is the value of P902 of the RDG2..KN).

This equipment combination works on a 1-to-1 basis. Values cannot be provided from the sensor to several RDG2..KN room thermostats.

For applications in S-Mode, set the objects for humidity and room temperature of the RDG2..KN to **Receive** in ETS. The thermostat then works with the values acquired by the sensor. Default setting **Transmit** indicates that the RDG2..KN provides the local room temperature and relative humidity over the bus. One sensor sends data to several thermostats.

### 4.7.13 Setpoints and sequences

#### 2-pipe applications

In changeover applications, the Comfort setpoints for heating and cooling sequence are the same ( $w$ ).

In 2-pipe applications with electric heater, the Comfort setpoint is either at the first heating sequence (in heating mode) or at the cooling sequence (in cooling mode).

In 2-pipe applications with radiator, the Comfort setpoint is either at the radiator sequence (in heating mode) or at the cooling sequence (in cooling mode).

The setpoints for Economy and Protection are below the Comfort setpoints (for heating) and above the Comfort setpoints (for cooling).

They can be set via P019, P020 (Economy) and P100, P101 (Protection).

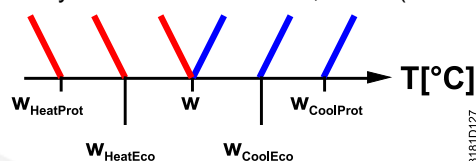

| Application                           | Comfort mode |         | Economy/Protection mode |         |
|---------------------------------------|--------------|---------|-------------------------|---------|
|                                       | Heating      | Cooling | Heating                 | Cooling |
| 2-pipe                                |              |         |                         |         |
| 2-pipe with electric heater           |              |         |                         |         |
| 2-pipe with radiator                  |              |         |                         |         |
| 2-pipe/<br>2-stage heating or cooling |              |         |                         |         |

1) If P027 = On

W = Setpoint in Comfort mode

$W_{HeatEco/Prot}$  = Setpoint heating in Economy or Protection mode

$W_{CoolEco/Prot}$  = Setpoint cooling in Economy or Protection mode

YR = Radiator sequence

YE = Electric heater sequence

### 4-pipe applications

In 4-pipe applications, the Comfort setpoint ( $w$ ) is in the middle of the dead zone, between the heating and cooling sequences.

The dead zone can be adjusted via P055.

If manual changeover is selected, either the cooling sequence or the heating sequence is released. In this case, the Comfort setpoint is at the selected heating or cooling sequence.

| Application                 | Comfort mode                    |                                                               |                                                               | Economy/Protection mode |
|-----------------------------|---------------------------------|---------------------------------------------------------------|---------------------------------------------------------------|-------------------------|
|                             | Heating and cooling<br>P010 = 1 | Heating only <sup>1)</sup> or heating and cooling<br>P010 = 2 | Cooling only <sup>1)</sup> or heating and cooling<br>P010 = 2 | Heating and/or cooling  |
| 4-pipe                      |                                 |                                                               |                                                               |                         |
| 4-pipe with electric heater |                                 |                                                               |                                                               |                         |
| 4-pipe/2-stage (RDG2..KN)   |                                 |                                                               |                                                               |                         |

<sup>1)</sup> Manual changeover, P001 = 3

$W$  = setpoint in Comfort mode

$W_{HeatEco/Prot}$  = heating setpoint for Economy or Protection mode

$W_{CoolEco/Prot}$  = cooling setpoint for Economy or Protection mode

YE = electric heater sequence

## 4.8 Control outputs

### 4.8.1 Overview

#### Overview of control outputs

Different control output signals are available and defined during commissioning (see below).

| Control output                | On/Off                   | PWM                     | 3-position                | DC 0...10 V              | On/Off 3-wire             |
|-------------------------------|--------------------------|-------------------------|---------------------------|--------------------------|---------------------------|
| Product No.                   |                          |                         |                           |                          |                           |
| RDG20..                       | Y1, Y2, Y3<br>(3 x NO *) | Y1, Y2, Y3<br>(3 x PWM) | Y1/Y3, Y2/Y4<br>(2 x ▼/▲) | ---                      | Y1/Y3, Y2/Y4<br>(2 x ▼/▲) |
| RDG26..                       | Q1, Q2<br>(2 x NO)       | ---                     | ---                       | Y10, Y20, Y30,<br>U1 **) | ---                       |
| RDG26.. with<br>6-port valves |                          |                         |                           | Y10 ***)                 |                           |

#### Notes

\*) NO: Normally open

\*\*) Multifunctional input/output U1 as DC output in 4-pipe/2-stage application.

\*\*\*) RDG260 with 6-port valves supports DC 0...10 V, DC 2...10 V and inverse signals.

#### On/Off control signal (2-position)

The valve receives the On command via control output Y1 (Q1 on RDG26..) or Y3 (Q2 on RDG26..), if:

1. The acquired room temperature is below the setpoint (for heating) or above the setpoint (for cooling),
2. The control outputs are inactive for more than the "Minimum output off time" (factory setting 1 minute, adjustable via P213).

The valve receives the Off command, if:

1. The acquired room temperature is above the setpoint (for heating) or below the setpoint (for cooling),
2. The valve is active for more than the "Minimum output on time" (factory setting 1 minute, adjustable via P212).

#### Note

- For switching differential (P051, P053, P054), see Control sequences [→ 86].

#### On/Off control signal (3-wire)

The valve receives the On command via control output Y1 or Y2 on RDG20..KN, if:

1. The acquired room temperature is below the setpoint (for heating) or above the setpoint (for cooling),
2. The control outputs are inactive for more than the "Minimum output off time" (factory setting 1 minute, adjustable via P213).

The valve receives the Off command via control output Y3 or Y4 on RDG20..KN, if:

1. The acquired room temperature is above the setpoint (for heating) or below the setpoint (for cooling),
2. The valve is active for more than the "Minimum output on time" (factory setting 1 minute, adjustable via P212).

#### Note

- For switching differential (P051, P053, P054), see Control sequences [→ 86].

#### Electric heater control signal (On/Off)

The electric heater receives an On command via the auxiliary heating control output (RDG26..KN: Q2, RDG20..KN: Y2 or Y3, see Mounting Instructions [→ 6] [1] & [2]), if

1. The acquired room temperature is below the "Setpoint for electric heater",
2. The electric heater is switched off for at least 1 minute.

The Off command for the electric heater is output, if

1. The acquired room temperature is above the setpoint (electric heater),
2. The electric heater is switched on for at least 1 minute.

**⚠ CAUTION! A safety limit thermostat (to prevent overtemperature) must be provided externally.**

**Note**

The electric heater can be controlled via the On/Off control output (RDG26..KN: Q2, RDG20..KN: Y2 or Y3) by setting P203 or P204 to 4. For adaptive temperature compensation (P217: RDG26..KN): see 2-pipe fan coil unit with electric heater [→ 91], 4-pipe fan coil unit with electric heater [→ 105].

**3-position control signal (RDG20.. only)**

Heating: Output Y1 provides the Open command, and Y3 the Close command to the 3-position actuator. Cooling: Same with Y2 and Y4.

The factory setting for the actuator run time is 150 seconds. It can be adjusted via P214 (Y1 and Y3) or P215 (Y2 and Y4).

The parameters are displayed only, if 3-position is selected via DIP switches 7 and 8.

**Synchronization**

1. When the thermostat is powered up, a close command for the actuator run time by + 150 % is issued to ensure the actuator closes fully and synchronizes to the control algorithm.
2. When the thermostat calculates the positions "fully close" or "fully open", the actuator run time is extended by + 150 % to ensure the correct actuator position is synchronized to the control algorithm.
3. After the actuator reaches the position calculated by the thermostat, a waiting time of 30 seconds is applied to stabilize the outputs.

**PWM control (RDG20.. only)**

The demand calculated from the current room temperature and setpoint is supplied via Y1, Y2 Y3, and Y4 to the valve actuator as a PWM (pulse width modulation) signal for thermal actuators. The control output is activated for a period proportional to the heating/cooling demand and then switched off for the rest of the PWM interval.

The PWM algorithm cycle time is 1200 seconds (factory setting). It can be adjusted via P206 (Y1), P207 (Y2), P208 (Y3) or P209 (Y4). These parameters are only displayed if PWM is selected via DIP switches 7 and 8 and if PWM is selected via P201, P203, P204, P205.

Proposed setting range for optimization, especially for thermal valve actuators (STA, STP): 900 seconds (15 min) to 1800 seconds (30 min).

**Note**

- The proposed PWM cycle (900...1800 seconds) allows for controlling thermal valve actuators in parallel when used for floor heating/radiators.
- If several fan coils are controlled by the same room thermostat, it is impossible to ensure exact parallel running of 2 or more thermal valve actuators using the PWM control signal. We recommend setting On/Off (2-position) control signals or using motorized actuators with On/Off or 3-position control signal.
- For P-band (P050, P052, P054), see Control sequences [→ 86].

**PWM for electric heaters (RDG20..)**

To control electrical equipment, we recommend using a suitable external switching element to switch the maximum current.

If output Y2 controls external mechanical relays, the optimal run time (P207) depends on the technical characteristics of the equipment.

As initial setting, we suggest the following values, which can be modified within the described setting range as needed:

- Electric heater applications: 300 s (5 min) / range 30...300 s (5 min)
- Electric radiator applications: 1200 s (20 min) / range 120...1800 s (30 min)
- Electric floor heating: 1200 s (20 min) / range 30...1800 s (30 min)

If output Y2 controls one external solid state relay:

- Electric heater applications: 60 s (1 min) / range 15...60 s (1 min)
- Electric radiator applications: 300 s (5 min) / range 30...300 s (5 min)
- Electric floor heating: 600 s (10 min) / range 30...900 s (15 min)

To avoid burn-off of mechanical contacts by frequent switching, use a current valve in place of a relay or contactor.

#### Note

To avoid possible supply problems, when many consumers are switching on at the same time in a building, consider the following:

- Set slightly different PWM cycles
- Do not switch all rooms to Comfort at the same time

#### DC 0...10 V control

This function is available with RDG26..KN only.

#### DC 0...10 V for valve actuators

The demand calculated by PI control from the current room temperature and setpoint is provided via Y10, Y20, Y30 and U1 (RDG2..KN: U1, for 4-pipe/2-stage applications) to the valve actuator as a continuous DC 0...10 V signal.

#### Note

- Parameter P256 (RDG264KN only), P260 & P261 (RDG26..KN) sets the heating flow limitation if PICV is installed at output for heating and cooling. See Additional functions [→ 53].
- For P-band (P050, P052, P054), see Control sequences [→ 86].

#### DC 0...10 V for electric heaters

- The demand calculated by PI control from the current room temperature and setpoint is provided via Y20 as a continuous DC 0...10 V signal
- The signal converter (SEM61.4) converts the DC 0...10 V signal to AC 24 V PDM pulses for the current valve
- The current valve (SEA45.1) supplies the electric heater with pulsed current

#### Note

The electric heater can be controlled via the On/Off control output (Q2) by setting P203 or P204 to 4. For adaptive temperature compensation, see 2-pipe fan coil unit with electric heater [→ 91].

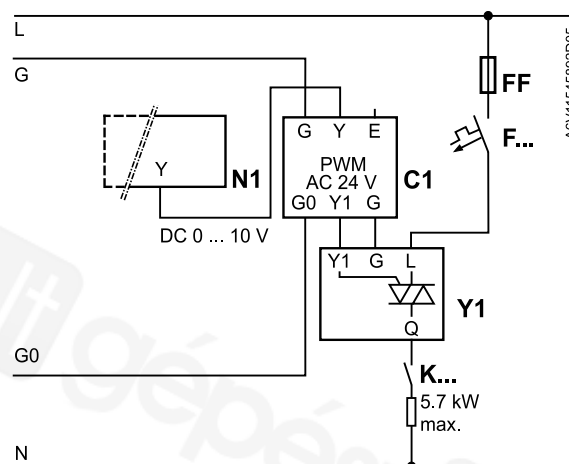

- N1 RDG26..KN
- C1 Signal converter SEM61.4 (see Data Sheet N5102)
- Y1 Current valve SEA45.1 (see Data Sheet N4937)
- K... Safety loop (e.g. safety thermostat and high-temperature cutout)
- FF Very fast-acting fuse
- F... Overcurrent trip

**DC 0...10 V  
DC 2...10 V  
for 6-port control ball  
valve (RDG26.. only)**

The RDG26.. can control a 6-port control ball valve that provides heating and cooling within one DC 0...10 V or DC 2...10 V signal.

These 2 signals allow for controlling Siemens valves as well as DC 2...10 V valves by other suppliers.

For the same application, RDG26.. can also provide an inverse signal DC 10...0 V or DC 10...2 V signal for inversed hydraulic connections on the valve.

The selection of the signal is set with P201.

|          | Description                                               | Explanations                                                                                                                  |
|----------|-----------------------------------------------------------|-------------------------------------------------------------------------------------------------------------------------------|
| P201 = 6 | 6-port valve (DC 0...10 V control signal)                 | Suitable for Siemens and competitor 6-port control valves and actuators with DC 0...10 V signal                               |
| P201 = 7 | 6-port valve (DC 2...10 V control signal)                 | Suitable for competitor 6-port control valves and actuators with DC 2...10 V signal (e.g. Belimo)                             |
| P201 = 8 | inverse signal, 6-port valve (DC 10...0 V control signal) | Useful for inversed hydraulic connection on the 6-port control ball valve with Siemens or competitor DC 0...10 V actuator*    |
| P201 = 9 | inverse signal, 6-port valve (DC 10...2 V control signal) | Useful for inversed hydraulic connection on the 6-port control ball valve with competitor DC 2...10 V actuator (e.g. Belimo)* |

\* Inverting the signal might cause hydraulic balancing issues

## 4.8.2 Control output configuration for 6-port valve (P201)

DC 0...10 V  
DC 2...10 V  
(RDG26.. only)

The RDG26.. can control an actuator connected to a 6-port control ball valve or a 6-port PICV, that provides heating and cooling with one DC 0...10 V or DC 2...10 V signal. The control output is Y10 and cannot be changed.

The 2 signals control Siemens and third-party valves/actuators.

For the same application, RDG26.. can also provide an inverse signal DC 10...0 V or DC 10...2 V signal for inversed hydraulic connections on the valve.

The control signal is set via P201. See tables below for details.

### Note

For supporting the actuators **GDB161.9../6W**, the thermostat control algorithm for P201 values (6, 7, 8 and 9) is adjusted to optimize temperature control performance.

A new RDG26.. that controls an older actuator GDB161.9E or third-party actuator, must set P201 to 10 or 11. This setting is also important when replacing devices in the field.

See tables below for details.

|           | Description                                                    | Explanation                                                                                                                   |
|-----------|----------------------------------------------------------------|-------------------------------------------------------------------------------------------------------------------------------|
| P201 = 6  | 6-port valve (DC 0...10 V control signal)                      | Suitable for Siemens 6-port control valves and actuators with DC 0...10 V signal                                              |
| P201 = 7  | 6-port valve (DC 2...10 V control signal)                      | Suitable for Siemens 6-port control valves and actuators with DC 2...10 V signal                                              |
| P201 = 8  | inverse signal, 6-port valve (DC 10...0 V control signal)      | For inversed hydraulic connection on the 6-port control ball valve with Siemens DC 0...10 V actuator *                        |
| P201 = 9  | inverse signal, 6-port valve (DC 10...2 V control signal)      | For inversed hydraulic connection on the 6-port control ball valve with Siemens DC 2...10 V actuator *                        |
| P201 = 10 | 6-port valve (DC 0...10 V control signal) 3 <sup>rd</sup> part | Suitable for Siemens actuators <b>GDB161.9E</b> or competitor DC 0...10 V actuators, with 6-port control valves               |
| P201 = 11 | 6-port valve (DC 2...10 V control signal) 3 <sup>rd</sup> part | Suitable for Siemens actuators <b>GDB161.9E</b> or competitor DC 2...10 V actuators, with 6-port control valves (e.g. Belimo) |

\* Inverting the signal may cause hydraulic balancing issues

Version compatibility RDG's, actuators and valves:

| Actuator / valve combination                                                   | Product: Product index                                                                                                                                 | P201                        |
|--------------------------------------------------------------------------------|--------------------------------------------------------------------------------------------------------------------------------------------------------|-----------------------------|
| GDB161.9../6W with 6-port PICV VWPG51.. or 6-port ball valve VWG41.. / VWG42.. | <ul style="list-style-type: none"> <li>● RDG260KN...: D or higher</li> <li>● RDG264KN...: B or higher</li> <li>● RDG260T...: Z, A or higher</li> </ul> | 6, 7, 8, 9                  |
| GDB161.9E with 6-port ball valve VWG41.. / VWG42..                             | <ul style="list-style-type: none"> <li>● RDG260KN...: Z, A, B, C</li> <li>● RDG264KN...: Z, A</li> </ul>                                               | 6, 7, 8, 9                  |
| GDB161.9E with 6-port ball valve VWG41.. / VWG42..                             | <ul style="list-style-type: none"> <li>● RDG260KN...: D or higher</li> <li>● RDG264KN...: B or higher</li> <li>● RDG260T...: Z, A or higher</li> </ul> | 10, 11 <sup>1)</sup>        |
| GDB161.9../6W with 6-port PICV VWPG51.. or 6-port ball valve VWG41.. / VWG42.. | <ul style="list-style-type: none"> <li>● RDG260KN...: Z, A, B, C</li> <li>● RDG264KN...: Z, A</li> </ul>                                               | Need new RDG. <sup>2)</sup> |

### Note

1) When replacing RDG260.. connected to the actuator GDB161.9E, verify the settings for control output signal P201.

2) RDG with previous product indices do not support the GDB161.9../6W actuators. We recommend upgrading (via KNX SW download tool) or replacing the RDG260.. with a new version.



### 4.8.3 Control output configuration (setting via DIP switches 7/8 or tool, and P201/P203/P204/P205)

#### Overview

| Application                                                      | Fan         |                     | Control outputs  |                   |                    |                     |                 | Product no.<br>RDG.. |
|------------------------------------------------------------------|-------------|---------------------|------------------|-------------------|--------------------|---------------------|-----------------|----------------------|
|                                                                  | DC 0...10 V | 3-speed/<br>1-speed | Mod. DC 0...10 V | On/Off<br>(2-pos) | On/Off<br>(3-wire) | Mod. PWM<br>(2-pos) | Mod. 3-<br>pos. |                      |
| 2-pipe                                                           | ✓           | ✓                   |                  | ✓                 | ✓                  | ✓                   | ✓               | 20..                 |
|                                                                  | ✓           | ✓                   | ✓                |                   |                    |                     |                 | 26..                 |
|                                                                  | ✓           |                     |                  | ✓                 |                    |                     |                 | 26..                 |
| 2-pipe with electric heater                                      | ✓           | ✓                   |                  | ✓                 | ✓                  | ✓                   | ✓               | 20..                 |
|                                                                  | ✓           | ✓                   | ✓                |                   |                    |                     |                 | 26..                 |
|                                                                  | ✓           |                     | ✓                | ✓                 |                    |                     |                 | 26..                 |
| 2-pipe with radiator/floor heating                               | ✓           | ✓                   |                  | ✓                 | ✓                  | ✓                   | ✓               | 20..                 |
|                                                                  | ✓           | ✓                   | ✓                |                   |                    |                     |                 | 26..                 |
|                                                                  | ✓           |                     | ✓                | ✓                 |                    |                     |                 | 26..                 |
| 2-pipe/2-stage, cooling or heating                               | ✓           | ✓                   |                  | ✓                 | ✓                  | ✓                   | ✓               | 20..                 |
|                                                                  | ✓           | ✓                   | ✓                |                   |                    |                     |                 | 26..                 |
|                                                                  | ✓           |                     | ✓                | ✓                 |                    |                     |                 | 26..                 |
| 4-pipe                                                           | ✓           | ✓                   |                  | ✓                 | ✓                  | ✓                   | ✓               | 20..                 |
|                                                                  | ✓           | ✓                   | ✓                |                   |                    |                     |                 | 26..                 |
|                                                                  | ✓           |                     | ✓                | ✓                 |                    |                     |                 | 26..                 |
| 4-pipe with electric heater                                      | ✓           | ✓                   |                  | ✓                 |                    | ✓                   | ✓ <sup>1)</sup> | 20..                 |
|                                                                  | ✓           | ✓                   | ✓                |                   |                    |                     |                 | 26..                 |
|                                                                  | ✓           |                     | ✓                | ✓ <sup>2)</sup>   |                    |                     |                 | 26..                 |
| 4-pipe/2-stage                                                   | ✓           | ✓                   |                  | ✓                 |                    | ✓                   |                 | 20..KN               |
|                                                                  | ✓           | ✓                   | ✓                |                   |                    |                     |                 | 26..KN               |
| Heating / Cooling with 6-port valve                              |             |                     | ✓                |                   |                    |                     |                 | 26..                 |
| Heating / Cooling with 6-port valve as changeover and PICV valve | ✓           |                     | ✓                | ✓ <sup>3)</sup>   |                    |                     |                 | 26..                 |
| Heating / Cooling with 6-port PICV                               | ✓           |                     | ✓                | ✓ <sup>3)</sup>   |                    |                     |                 | 26..                 |







<sup>1)</sup> Only available for cooling actuator

<sup>2)</sup> Only selectable for electrical heater

<sup>3)</sup> Relay outputs for 6-port valve as changeover

Note: On/off (2-pos) on RDG20.. are a triac outputs (max 1A), and relay outputs (max 5(4)A) on RDG26..

**RDG20..** The type of the control outputs (2- or 3-position) is set via DIP switches 7 and 8. Patterns of DIP switches 7 and 8:

| DIP NO.: 7...8 → ON =  , OFF =  | <br>7 8 | <br>7 8 | <br>7 8 | <br>7 8 |
|---------------------------------------------------------------------------------------------------------------------------------------------------------------------------------------------------|------------------------------------------------------------------------------------------|-------------------------------------------------------------------------------------------|--------------------------------------------------------------------------------------------|--------------------------------------------------------------------------------------------|
| Y1/Y3 =                                                                                                                                                                                           | 2-position (PWM)                                                                         | 2-position (PWM)                                                                          | 3-position                                                                                 | 3-position                                                                                 |
| Y2/Y4 =                                                                                                                                                                                           | 2-position (PWM)                                                                         | 3-position                                                                                | 2-position (PWM)                                                                           | 3-position                                                                                 |

### Notes

- If 2-position (PWM) is selected via DIP switches, the control output is On/Off (factory setting). To select PWM (pulse width modulation), set P201, P203 and/or P204, P205 to 3.
- 4-pipe with electric heater: As the electric heater requires 1 of 4 outputs, only the cooling valve actuator can be 3-position.
- For commissioning via tool, all DIP switches have to be set to Off or related application configuration. Control outputs need to be set via tools.

For details on connecting field devices and setting the DIP switches, refer to the Mounting Instructions [→ 6] [1] & [2]..

### RDG26..

Applications with DC 0...10 V fan control (Y50) or without fan:

The type of valve actuator control outputs can be changed from DC 0...10 V (factory setting) to On/Off.

To select On/Off valve actuator control, set P201 and/or P203 to 4 or DIP switch 7 and/or 8 to ON.

Example for 4-pipe application:

- Cooling: DC 0...10 V Y10 (P201 = 5, default), On/Off on Q1 (P201 = 4)
- Heating: DC 0...10 V Y20 (P203 = 5, default), On/Off on Q2 (P203 = 4)

### Notes

- For 2-pipe and 2-stage application, P203 can be set to 3 or 4 to enable the swap function. See Additional functions [→ 53]
- The fan type is selected via P351 or DIP switch 6, see Fan control [→ 131]
- RDG26..KN On/Off valve actuator control on applications without fan function, setting sequence:
  - Set DIP switch 6 to OFF and P351 to 3
  - Disable the fan function by setting P350 to 0
  - Set the valve actuators to On/Off by setting P201 and/or P203 to 4
- For commissioning via tools, set all DIP switches to Off or the related application configuration. The control outputs must be set using tools

## 4.9 Fan control

### Overview fan outputs

In RDG20.. and RDG26.., the available fan output signals are one On/Off 1-speed/3-speed fan or one modulating fan DC 0...10 V and control type can be selected via P351.

The fan control signal (DC 0...10 V or 3-speed) is selected via DIP switch 6, local HMI (P351) or tool (ACS, ETS, ABT Site (RDG2..KN) or Siemens smartphone application PCT Go).

The fan operates in automatic mode or at the speed selected in manual mode.

In automatic mode, the fan speed is based on the setpoint and the current room temperature. When the room temperature reaches the setpoint, the control valve closes and the fan switches off or stays at fan speed I (min. fan speed) as per the setting of P029 (fan stage in dead zone Comfort mode).

The factory setting for "Fan in the dead zone" is Off.

Only one fan output at one time is On, either Q1, Q2 or Q3.

### Fan and control outputs

If the application is set via DIP switches and DIP 6 is set to Off:

- DC 0...10 V fan on Y50 is selected
- P351 = 3 (DC 0...10 V fan) cannot be modified
- 3-speed/1-speed fan output is not available

If the application is set via DIP switches and DIP 6 is set to On:

- 3-speed fan on Q1, Q2, Q3 is selected, P351 = 2
- 1-speed fan (on Q1) can be selected via HMI (P351 = 1) or via tools (ACS, ETS, ABT Site (RDG2..KN) or PCT Go)
- DC 0...10 V fan output is not available
- 3-speed fan output is enabled only if the application has also been selected via DIP switches

If all DIP switches are Off (commissioning via tool ACS, ETS, ABT Site (RDG2..KN) or PCT Go):

- Application and type of fan must be set and downloaded via tools
- If DC 0...10 V fan is set, the type of fan output cannot be modified via HMI
- If 3-speed or 1-speed is selected, P351 can be modified locally to 2 (3-speed) or 1 (1-speed)

Fan speed and mode can be changed via bus. (RDG2..KN)

For this purpose, the fan command value must be enabled.



Fan command value  
Enable fan command value



Fan operation  
Fan stage I-II-III  
Fan output

Fan speed and mode can be monitored via bus. (RDG2..KN)

**Fan control with modulating heating/cooling control (PWM, 3-pos or DC 0...10 V)**
**For 3-speed fan control:**

The individual switching points for each fan stage can be adjusted via P353...P355. The fan speed switch off point is 20% below the switch on point. The diagrams below show fan speed control for modulating PI control.

**For DC 0...10 V fan control:**

If DC 0...10 V fan control is selected, the fan switching points are set using the following parameters:

- P359 & P360: DC 0...10 V fan max. output
- P358: DC 0...10 V middle speed output
- P357: DC 0...10 V fan min. output
- P356: Switching point for fan

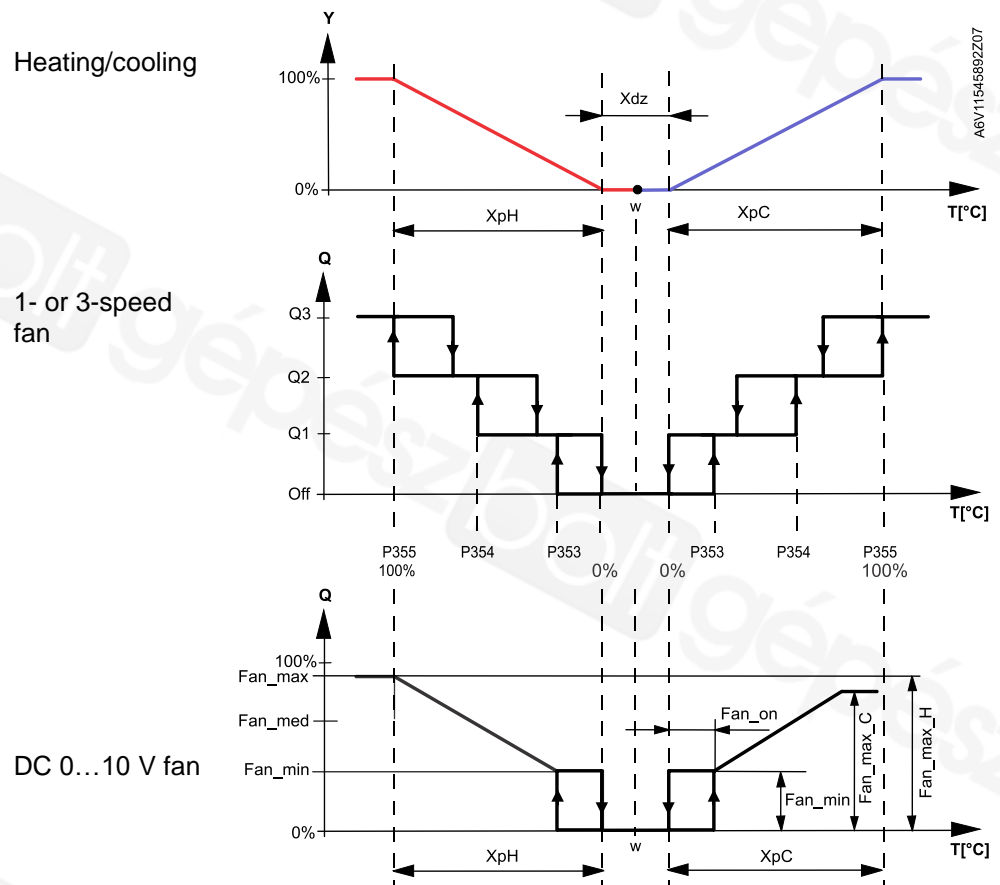

|          |                                    |             |                                                                  |
|----------|------------------------------------|-------------|------------------------------------------------------------------|
| $w$      | Room temperature setpoint          | $X_{dz}$    | Dead zone (P055)                                                 |
| $Q$      | Fan speed                          |             | Fan speed switching point                                        |
| YH       | Control demand "Heating"           | high (P355) | Fan speed switching point                                        |
| YC       | Control demand "Cooling"           | med (P354)  | Fan speed switching point low                                    |
| $X_{pH}$ | Proportional band "Heating" (P050) | (P353)      |                                                                  |
| $X_{pC}$ | Proportional band "Cooling" (P052) | $Fan_{max}$ | Max. DC 0...10 V fan speed (P359 for heating & P360 for cooling) |
|          |                                    | $Fan_{med}$ | Med. DC 0...10 V fan speed (P358)                                |
|          |                                    | $Fan_{min}$ | Min. DC 0...10 V fan speed (P357)                                |
|          |                                    | $Fan_{on}$  | Fan switch-on point (P356)                                       |

**Note**

The diagram only shows the proportional part of PI control.

**Fan control with On/Off heating/cooling control**

In applications with On/Off control:

1. The switching point for low fan speed is synchronized to the heating/cooling output. P353 (switching point fan speed low) is not relevant.
2. The maximum switching range of the fan ( $XpH_{Fan} / XpC_{Fan}$ ) is defined by the switching differential (SDH/SDC) via a reference table.

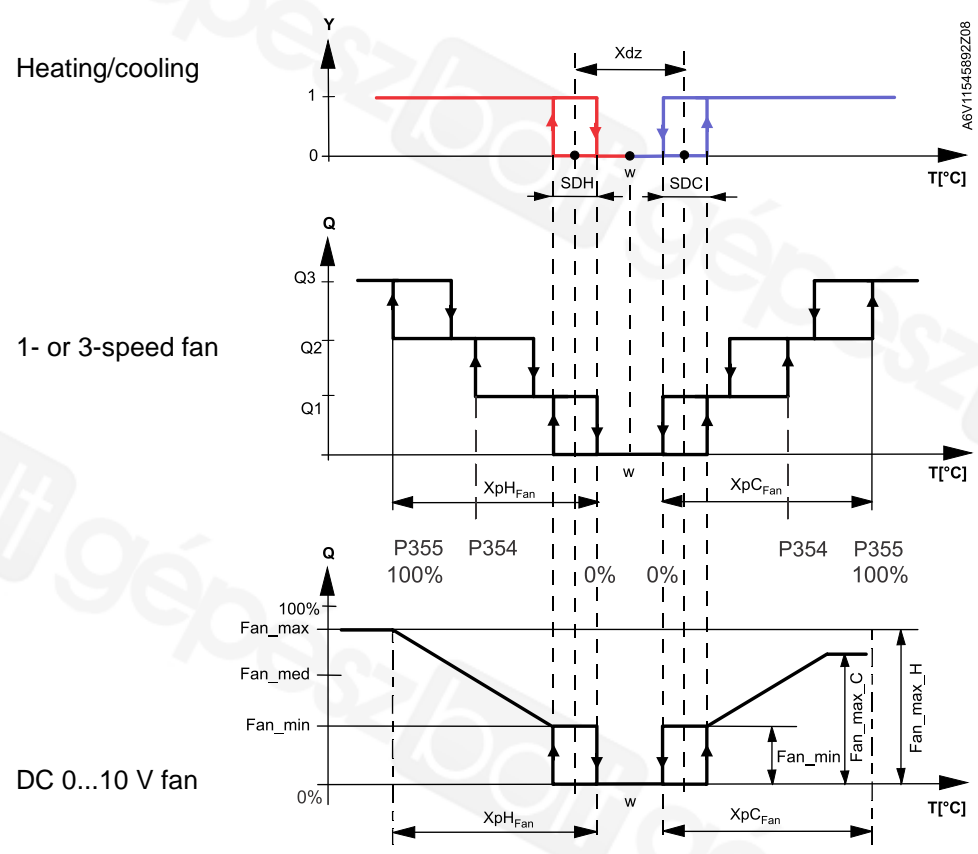

|                 |                                         |             |                                                                              |
|-----------------|-----------------------------------------|-------------|------------------------------------------------------------------------------|
| $T [^{\circ}C]$ | Room temperature                        | $X_{dz}$    | Dead zone (P055)                                                             |
| $w$             | Room temperature setpoint               | $XpH_{Fan}$ | Switching range for fan "Heating" (Table)                                    |
| $Q$             | Fan speed                               | $XpC_{Fan}$ | Switching range for fan "Cooling" (Table)                                    |
| $Y$             | Control command "Valve"                 |             | Fan 3-speed switching point high (P355)                                      |
| $SDH$           | Switching differential "Heating" (P051) |             | Fan 3-speed switching point med (P354)                                       |
| $SDC$           | Switching differential "Cooling" (P053) |             | Fan speed                                                                    |
|                 |                                         |             | $Fan_{max}$ Max. DC 0...10 V fan speed (P359 for heating & P360 for cooling) |
|                 |                                         |             | $Fan_{med}$ Med. DC 0...10 V fan speed (P358)                                |
|                 |                                         |             | $Fan_{min}$ Min. DC 0...10 V fan speed (P357)                                |

**Reference table with On/Off control**

| SDH/SDC [K]               | 0.5 | 1.0 | 1.5 | 2.0 | 2.5 | 3.0 | 3.5 | 4.0 | >4.5 |
|---------------------------|-----|-----|-----|-----|-----|-----|-----|-----|------|
| $XpH_{Fan}/XpC_{Fan}$ [K] | 2   | 3   | 4   | 5   | 6   | 7   | 8   | 9   | 10   |

**1-speed/3-speed fan**

The thermostat can control a 1- or 3-speed fan (selected via P351). A 1-speed fan is connected to terminal Q1, and a 3-speed fan to terminals Q1, Q2 and Q3.

**Manual operation**  
**DC 0...10 V fan**

Fan speed I = Min. fan speed selectable via P357

Fan speed II = Medium fan speed selectable via P358

When the DC fan characteristic is not linear, fan speed II can be adapted to an efficient manual speed II.

Fan speed III = Max. fan speed selectable via P359 (heating), P360 (cooling)

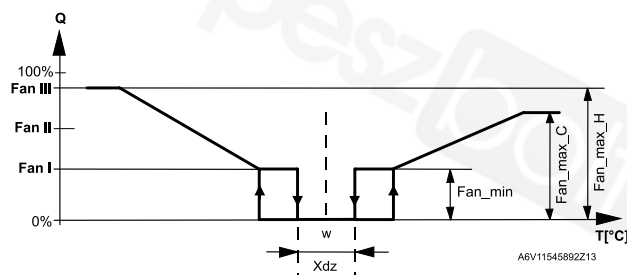

Note: Manual fan settings do not influence control signals "Heating" and "Cooling".

**Note**

When heating with electric heater only, manual fan speed I is unavailable to guarantee the necessary minimum air flow for the electric heater and to avoid overheating.

**2 sequences**  
**heating/cooling**

For heating or cooling with 2 sequences (e.g. heating with a heating coil and an electric heater, or 2-stage cooling), the fan is always synchronized to the 1<sup>st</sup> stage.

**Fan in the 2<sup>nd</sup> stage**

For 2-pipe and 2-stage applications, based on the equipment, the fan may have to run in the 2-stage only (in the 1<sup>st</sup> stage the fan remains Off), either in the heating or cooling sequence.

The following settings are available by selecting fan control P350 accordingly:

|                                                     |                                                                                                                                   |
|-----------------------------------------------------|-----------------------------------------------------------------------------------------------------------------------------------|
| P350 = 4: 2 <sup>nd</sup> stage                     | Fan runs in the 2 <sup>nd</sup> stage in heating and cooling ( <b>example 1</b> or <b>2</b> when combined with the swap function) |
| P350 = 5: Heating and 2 <sup>nd</sup> stage cooling | Fan runs in heating mode and in the 2 <sup>nd</sup> stage cooling ( <b>example 3</b> )                                            |
| P350 = 6: Cooling and 2 <sup>nd</sup> stage heating | Fan runs in cooling mode and in the 2 <sup>nd</sup> stage heating                                                                 |
| P350 = 7: 2 <sup>nd</sup> stage cooling only        | Fan runs in the 2 <sup>nd</sup> stage cooling only and not in heating mode                                                        |
| P350 = 8: 2 <sup>nd</sup> stage heating only        | Fan runs in the 2 <sup>nd</sup> stage heating only and not in cooling mode                                                        |

**Example 1**

The fan runs only in the 2<sup>nd</sup> stage in the heating and cooling sequence (2-pipe and 2-stage application).

Set both P201 and P203 to 4 or 5 (based on the requested control signal) and set P350 to 4 (fan in the 2<sup>nd</sup> stage).

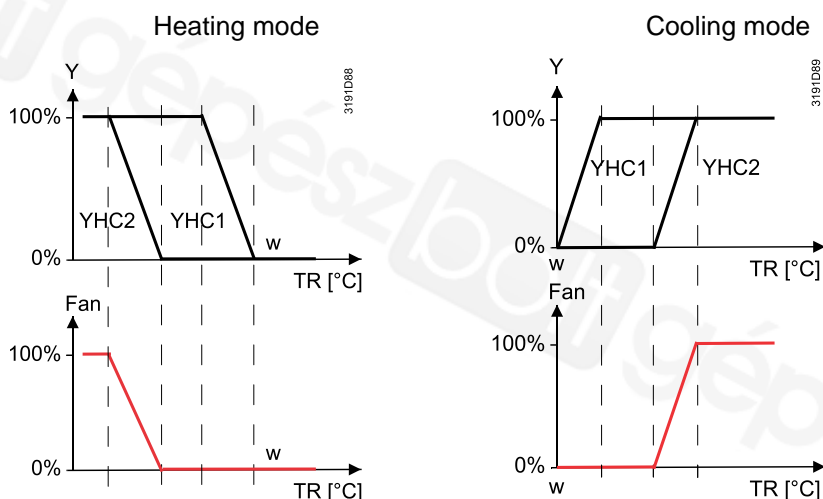

**Notes**

- The output for the 1<sup>st</sup> stage (YHC1) in heating mode is also the 1<sup>st</sup> stage in cooling
- This function is available for DC/3-speed/1-speed fans

**Example 2**

We recommend enabling the swap function on applications with fan coil units and floor heating/cooling. In this application, the fan runs during cooling demand (fan coil unit and floor cooling) and only in the 2<sup>nd</sup> heating stage (with the fan coil unit). Set P254 to On or Off, depending on the selected control signal (swap function), and set P350 to 4 (fan in the 2<sup>nd</sup> stage).

**Example 3**

The fan runs during heating demand and only in the 2<sup>nd</sup> cooling stage, e.g. for applications with fan coil units and radiant heating/cooling panels. This setting is available only when P350 is set to 5, and the swap function is selected (P254 to On or Off).

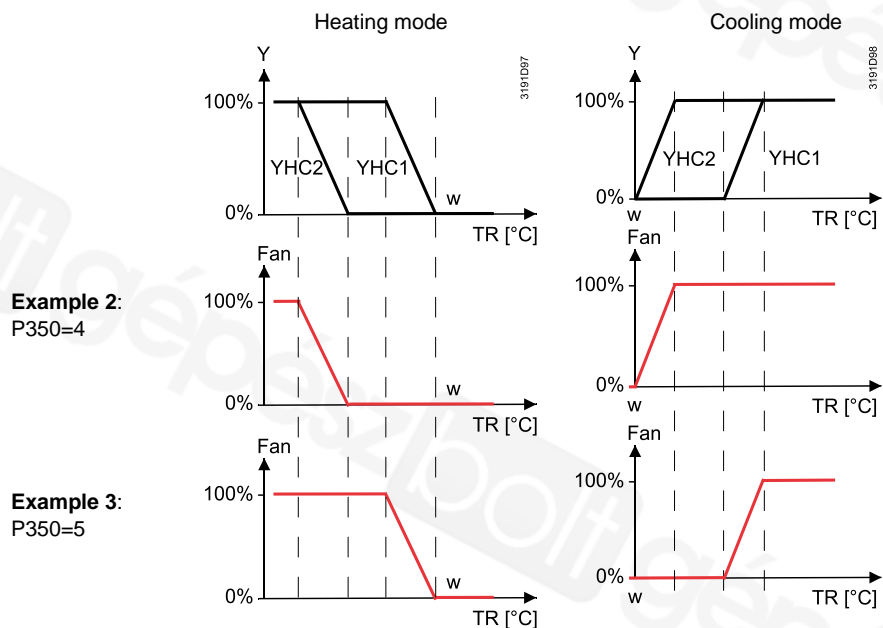

**Notes**

- Swap function: The output for the 1<sup>st</sup> stage in heating mode is the 2<sup>nd</sup> stage for cooling
- This function is available for DC/3-speed/1-speed fans

**Examples, other combinations**

The following table shows the relation between fan behavior (switching range fan  $XpH_{Fan}/XpC_{Fan}$  as per reference table or proportional band  $XpH/XpC$ ) for 2-pipe / 2-stage applications depending on the selected output signals and synchronization of the fan to the first or second sequence.

| Combination | 1 <sup>st</sup> stage signal | 2 <sup>nd</sup> stage signal | Fan type | Fan synchro              | Fan behavior                      |
|-------------|------------------------------|------------------------------|----------|--------------------------|-----------------------------------|
| 1           | On/off                       | On/off                       | DC       | 1 <sup>st</sup> sequence | $XpH_{Fan}/XpC_{Fan}$ , P-control |
| 2           | DC                           | DC                           | DC       | 1 <sup>st</sup> sequence | $XpH/XpC$ , P/PI control          |
| 3           | On/off                       | On/off                       | DC       | 2 <sup>nd</sup> sequence | $XpH_{Fan}/XpC_{Fan}$ , P-control |
| 4           | DC                           | DC                           | DC       | 2 <sup>nd</sup> sequence | $XpH/XpC$ , P/PI control          |
| 5           | On/off                       | DC                           | DC       | 1 <sup>st</sup> sequence | $XpH_{Fan}/XpC_{Fan}$ , P-control |
| 6           | On/off                       | DC                           | DC       | 2 <sup>nd</sup> sequence | $XpH/XpC$ , P/PI control          |
| 7           | DC                           | On/off                       | DC       | 1 <sup>st</sup> sequence | $XpH/XpC$ , P/PI control          |
| 8           | DC                           | On/off                       | DC       | 2 <sup>nd</sup> sequence | $XpH_{Fan}/XpC_{Fan}$ , P-control |
| 9           | DC                           | DC                           | 3-speed  | 1 <sup>st</sup> sequence | $XpH/XpC$ , P/PI control          |
| 10          | DC                           | DC                           | 3-speed  | 2 <sup>nd</sup> sequence | $XpH/XpC$ , P/PI control          |

**Fan operation as per heating/cooling mode, or disabled**

Fan operation can be limited to be active with cooling only or heating only, or even disabled via P350.

When fan operation is disabled, the fan symbol on the display disappears and pressing the fan button has no impact.

This function allows for using the thermostat in universal applications such as chilled/heated ceilings and radiator, etc. (see Chilled/heated ceiling and radiator applications [→ 107]).

**Fan minimum on- time**

In automatic mode, a dwelling time of 2 minutes (factory setting) is active. The fan maintains each speed for at least 2 minutes before changing to the next speed. The minimum on-time can be adjusted from 1...6 minutes via P362.

**Periodic Fan kick (P363, P364)**

In automatic fan mode and with the room temperature in the dead zone, the control valve is normally closed and the fan is disabled. With the periodic fan kick function, the fan can be released from time to time at low speed for a minimum on-time (see above) even if the valve is closed.

This function is used to prevent damage from moisture due to a lack of air circulation, or to allow a return air temperature sensor to acquire the correct room temperature.

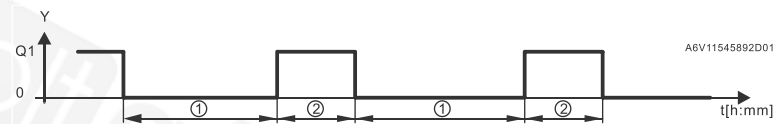

- ① Periodic fan kick
- ② Minimum on-time

Periodic fan kick time can be selected individually for Comfort via P363, and via P364 for Economy.

**Notes**

- Fan kick value 0 means the fan runs continuously in the dead zone (only selectable in Economy via P364)
- Fan kick value 1 and higher: Value in minutes
- Fan kick value Off means the fan does not run in the dead zone

**Fan stage in dead zone P029**

The fan speed in the dead zone (Comfort mode) can be set via P029 (Service level) ask per customer preferences.

To save energy, the manual fan in the dead zone is controller same as the auto fan (P029 = 3, 4 or 5).

The following options are available:

- Auto fan does not run in the dead zone
- Auto fan runs in the dead zone at low speed during heating and cooling (P029 = 1)
- Auto fan runs in the dead zone at low speed during cooling only (P029 = 2). During heating, the fan does not run in the dead zone.
- Auto or manual fan does not run in the dead zone (P029 = 3)
- Auto or manual fan runs in the dead zone at low speed during heating and cooling (P029 = 4)
- Auto or manual fan runs in the dead zone at low speed during cooling only (P029 = 5). During heating, the fan does not run in the dead zone.

When the fan does not run in the dead zone (P029 = 0), " Periodic fan kick Comfort" (P363) function can be enabled to periodically ventilate the room.



**Fan start kick (P361)**

When the fan starts from standstill, it starts at speed 3 for 1 second to ensure safe fan motor start by overcoming inertia and friction (selected via P361).

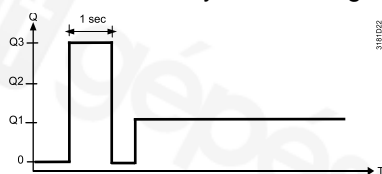

**Fan start, minimum water temperature (P366)**

In the heating sequence, when the return water temperature exceeds 30 °C (factory setting, P366), fan operation is enabled even if the fan start delay time (P365) is not reached.

Fan can be started manually. Blocking is only active in automatic mode.

Thermostat checks if the water temperature is above the setpoint only before releasing the fan. When the fan is running, even the water temperature below the setpoint, the thermostat does not stop the fan.

The universal input "coil temperature" (P150, P153 or P155 = 12) is required to activate this function.

**Fan overrun (P352)**

When the electric heater (2-pipe/4-pipe) is switched off, the fan overruns for 60 seconds (P352) to avoid overtemperature of the electric heater or prevent the thermal cutout from responding.

A minimal DC fan speed 2 is available on electrical heater applications with DC fan control.

For other applications, the fan overrun can be enabled by setting the expected running time to a max. value of 600 sec (P352) for drying the heating/cooling exchangers and reducing the risk of moisture after the system stops. The default value is 0. The fan is set to the minimal fan speed during fan overrun.

| <b>⚠ WARNING</b> |                                                                                                                                                                                                                               |
|------------------|-------------------------------------------------------------------------------------------------------------------------------------------------------------------------------------------------------------------------------|
|                  | <p><b>Fan failure</b></p> <p>In case of fan failure, the thermostat cannot protect the electric heater against overtemperature. For this reason, the electric heater must have a separate safety device (thermal cutout).</p> |

**Clean fan filter reminder**

The "Clean fan filter reminder" function counts the fan operating hours and displays message "FIL ▲" to remind users to change/clean the fan filter as soon as the threshold is reached. This does not impact thermostat, which continues to run normally. The function is set via P501 (default = Off (0)).

The "Clean filter reminder" is reset when the operating mode is manually set to Protection and back.



**Fan in Auto mode**

In Auto mode, the default fan mode is automatic. The fan mode can be changed to Manual by pressing the FAN button. The fan returns to automatic mode after each switchover from Comfort to Economy, and vice versa.

**Fan start delay**

To allow the heating/cooling coil to reach its temperature, fan start can be delayed by a time period set via P365.

## Example

Function for On/Off control outputs is listed as per the following figure:

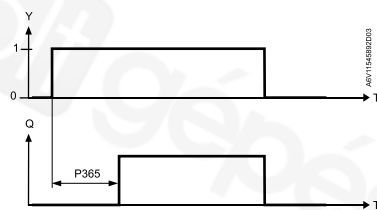

### Fan operation with combi valve PICV and a 6-port ball valve as changeover

Fan control is set to enable by default (P350 = 1), if the thermostat is set with control sequence "H/C ceiling with PICV and 6-port ball valve as changeover". For this application, where the combi valve PICV controls the flow rate and the 6-port ball valve works as changeover heating / cooling, fan control can:

- Also be disabled (P350 = 0)
- Run only in heating (P350 = 2) sequence
- Run only in cooling (P350 = 3) sequence

For this application, only DC fan control is available at output Y50.

## 4.10 Multifunctional input, digital input



The thermostat has 3 multifunctional inputs X1, X2 and U1.







An NTC type sensor like NTC 3k, a LG-Ni1000 (AI, analog input) or a switch (DI, digital input) can be connected to the input terminals. The functionality of the inputs can be configured via P150 + P151 for X1, P153 + P154 for X2, and P155 + P156 for U1 (RDG2..KN)/X3 (RDG2..T).



The current temperature or state of the inputs X1/X2 and U1 is available on the bus for monitoring purposes. (RDG2..KN)

The parameters can be set to the following values:



|                                                                                                                          | # | Input function                  | Description                                                                                                                                                                                                                                                                                                                                                                                                                                                                                                                 | Type<br>X1/X2/U1/<br>X3 |
|--------------------------------------------------------------------------------------------------------------------------|---|---------------------------------|-----------------------------------------------------------------------------------------------------------------------------------------------------------------------------------------------------------------------------------------------------------------------------------------------------------------------------------------------------------------------------------------------------------------------------------------------------------------------------------------------------------------------------|-------------------------|
|                                                                                                                          | 0 | Not used                        | No function                                                                                                                                                                                                                                                                                                                                                                                                                                                                                                                 | --                      |
|                                                                                                                          | 1 | External/return air temperature | Sensor input for external room temperature sensor or return air temperature sensor to acquire the current room temperature.                                                                                                                                                                                                                                                                                                                                                                                                 | AI                      |
| <br>Heating/<br>cooling<br>changeover | 2 | Heating/cooling changeover      | Sensor input for "Automatic heating/cooling changeover" function.<br>A switch can also be connected rather than a sensor. Important: Switching state configured via P151, P154, P156. See also Additional functions [→ 53].<br>Heating/cooling changeover is possible via bus. In this case, the function must not be assigned to local inputs X1, X2, U1. See also Additional functions [→ 53].<br>Diagnostic value <b>0 °C</b> is displayed for closed contact, <b>100 °C</b> for open contact, if a switch is connected. | AI/DI                   |
| <br>Window<br>contact                 | 3 | Window contact                  | Digital input to change over the operating mode to Protection.<br>If the window contact is active, user operations are ineffective and <b>OFF</b> is displayed.<br>Window contact is also possible via bus. In this case, do not assign the function to local inputs X1, X2 or U1. See also Operating modes [→ 31].                                                                                                                                                                                                         | DI                      |

|                                                                                                                | #  | Input function                               | Description                                                                                                                                                                                                                                                                                                                                                                          | Type<br>X1/X2/U1/<br>X3 |
|----------------------------------------------------------------------------------------------------------------|----|----------------------------------------------|--------------------------------------------------------------------------------------------------------------------------------------------------------------------------------------------------------------------------------------------------------------------------------------------------------------------------------------------------------------------------------------|-------------------------|
|                                                                                                                | 4  | Dewpoint monitor                             | Digital input for dewpoint sensor to detect condensation. Cooling is stopped in the event of condensation.                                                                                                                                                                                                                                                                           | DI                      |
| <br>Enable electric heater    | 5  | Enable electric heater                       | Digital input to enable/disable the electric heater via remote control.<br>Enable electric heater is also possible via bus. In this case, <b>do not</b> assign the function to local inputs X1, X2, U1. See also Control sequences [→ 86].                                                                                                                                           | DI                      |
| <br>Fault information         | 6  | Fault                                        | Digital input to signal an external fault (e.g.: dirty air filter).<br>If the input is active, <b>ALx</b> is displayed and a fault is sent on the bus. See also Fault and alarms function on KNX [→ 151].<br>(Alarm x, with x = 1 for X1, x = 2 for X2, x = 3 for U1).<br><b>Note:</b> Fault displays have no impact on thermostat operation. They merely represent a visual signal. | DI                      |
| <br>U1, X1, X2<br>(Digital)  | 7  | Monitor input (digital)<br>(RDG2..KN)        | Digital input to monitor the state of an external switch via bus                                                                                                                                                                                                                                                                                                                     | DI                      |
| <br>U1, X1, X2<br>(Digital) | 8  | Monitor input<br>(temperature)<br>(RDG2..KN) | Sensor input to monitor the state of an external sensor (e.g., NTC 3k) via bus.                                                                                                                                                                                                                                                                                                      | AI                      |
| <br>U1, X1, X2<br>(Temp.)   | 9  | Supply air temperature limitation            | Sensor input to acquire supply air temperature.<br>The thermostat controls the room temperature via built-in sensor. The control output (DC 0...10 V) is reduced if the supply air temperature drops below the min. limit or exceeds the max. limit (P063 , P064)                                                                                                                    | AI                      |
| <br>Presence detector       | 10 | Presence detector                            | Presence detector input switches the operating mode to Comfort when the room is occupied and returns to previous operating mode when the room is unoccupied.<br>Presence detector is also possible via bus. In this case, do not assign the function to local inputs X1, X2 or U1. See also Presence detector [→ 56].                                                                | DI                      |
|                                                                                                                | 11 | External temperature limit                   | The sensor is connected to the pipe and measures the temperature of the floor heating water. When the value exceeds the selected limit (P252), heating is stopped. See also Monitoring and limiting functions [→ 59]                                                                                                                                                                 | AI                      |
|                                                                                                                | 12 | Coil flow temperature                        | To avoid cooling flow air in the room, the sensor measures the coil water temperature and releases the fan only when the selected minimum water temperature limit is exceeded (P366). See also Fan control [→ 137].<br>To measure the flow temperature of the return flow delta temperature control                                                                                  | AI                      |

|                                                                                                                    | #  | Input function          | Description                                                                                                                                                                                                                                                                                                                                                                                                                                                          | Type<br>X1/X2/U1/<br>X3 |
|--------------------------------------------------------------------------------------------------------------------|----|-------------------------|----------------------------------------------------------------------------------------------------------------------------------------------------------------------------------------------------------------------------------------------------------------------------------------------------------------------------------------------------------------------------------------------------------------------------------------------------------------------|-------------------------|
| <br>Hotel<br>presence<br>detector | 13 | Hotel presence detector | Hotel presence detector input switches the operating mode to Economy when the room is unoccupied and symbol  is displayed (buttons are locked) and returns to previous operating mode when the room is occupied.<br><br>Hotel presence detector is also possible via bus. In this case, do not assign the function to local inputs X1, X2 or U1. See also Presence detector [→ 56]. | DI                      |
|                                                                                                                    | 14 | Coil return temperature | To save energy, the thermostat controls the valve to adjust flow speed when $\Delta T$ between flow and return temperature value is less than P061 or P062. See also Monitoring and limiting functions [→ 62].                                                                                                                                                                                                                                                       | AI                      |

- Control action can be changed from normally open (NO) and normally closed (NC) via P151, P154 or P156.
- Each input X1, X2 or U1/X3 must be configured with a different function (1...5 & 9...13). Exception: 1, 2 or 3 inputs can be configured as fault (6) or monitor input (7,8).
- X1 is factory-set to "External sensor" (1), X2 to "Not used" (0) or RDG200T & RDG260T: "H/C changeover" (2), and U1/X3 to "Window contact" (3) or RDG204KN & RDG264KN: "Not used" (0).

For more detailed information, see Application overview [→ 45].

#### Note

- For inputs X1, X2, or U1/X3, one physical switch can be used for up to 20 thermostats (parallel connection).
- In 4-pipe/2-stage application of RDG26..KN, U1 is fixed as DC output (YC2) and cannot be set as input.

Caution! Do not mix X1/X2 and U1/X3.

- For sensors on inputs X1, X2, or U1/X3, the maximum cable length is 80 m.

## 4.11 Handling system faults

### Temperature out of range

If the room temperature exceeds or drops below the measuring range, i.e. above 49 °C or below 0 °C, the limiting temperatures blink, e.g., **0 °C** or **49 °C**.

In addition, the heating output is activated if the current setpoint is not set to Off, the thermostat is in heating mode and the temperature is below 0 °C.

For all other cases, no output is activated.

The thermostat resumes Comfort mode as soon as the temperature is within the measuring range.

### Fault "Er1, Er2, Er3, Er4, Er5" on display

- If the built-in temperature or humidity sensor fails and no external temperature sensor is connected, fault message **Er1** is displayed on the thermostat. If EEPROM is damaged, fault message **Er2** is displayed on the thermostat. Replace the thermostat to measure the room temperature.
- If the external / remote temperature sensor fails and no external sensor is connected, if input X1/X2/U1 (RDG2..KN)/X3 (RDG2..T) is configured as AI except room temp external sensor/return (AI), fault message **Er3, Er4 or Er5** is displayed on the thermostat. Check related sensor input terminals.

| Fault                                                     | Thermostat | Fault information on bus |                            |
|-----------------------------------------------------------|------------|--------------------------|----------------------------|
|                                                           | Display    | Error code               | Default fault text         |
| Built-in sensor fails and no external sensor is connected | Er1        | ---                      | ---                        |
| EEPROM is damaged                                         | Er2        | ---                      | ---                        |
| External / remote sensor error                            | Er3        | 101                      | [N.X1] sensor error        |
| External / remote sensor error                            | Er4        | 102                      | [N.X2] sensor error        |
| External / remote sensor error                            | Er5        | 103                      | [N.U1]/[N.X3] sensor error |
| Internal CO <sub>2</sub> sensor error                     | Er6        | ---                      | ---                        |



For fault status messages on the bus, see Fault and alarms function on KNX [→ 151].

## 4.12 KNX communications (RDG2..KN)

RDG2..KN thermostats support communications as per KNX specifications.

|          |                                                                                            |
|----------|--------------------------------------------------------------------------------------------|
| S-Mode   | Standard mode; engineering via group addresses.                                            |
| LTE-Mode | Logical Tag Extended mode, for easy engineering, is used together with Synco and ABT Site. |
| PL-Link  | Logical Tag Extended mode, for easy engineering, is used together with Desigo PXC4/5/7     |

### 4.12.1 S-Mode

This mode corresponds to KNX communications.

Connections are established via ETS by assigning communication objects to group addresses.

### 4.12.2 M/S, Manager/subordinate configuration in KNX S-Mode

Manager and subordinate can be bound via parameters or communication objects in S-Mode.

#### Setting manager or subordinate

- 1 Open the project in ETS and select a device.
- 2 Click the **Parameters** tab and set parameter P258 as **Manager** or **Subordinate**.

0.2.3 RDG204KN Room Thermostat > Basic Configuration

|                                |                                    |                                                                            |
|--------------------------------|------------------------------------|----------------------------------------------------------------------------|
| Basic Configuration            | [DIP] Plant type                   | 2-pipe / 2 stage                                                           |
| Device                         | [P001] Control sequence            | Cooling only                                                               |
| Room Operating Mode            | [P258] Manager / Subordinate (M/S) | <input type="radio"/> Subordinate <input checked="" type="radio"/> Manager |
| Room Temperature and Setpoi... | [P450] Control strategy            | Temp. (T) + Air quality (IAQ)                                              |
| Controller                     |                                    |                                                                            |
| Alarm                          |                                    |                                                                            |
| Inputs                         |                                    |                                                                            |
| Outputs                        |                                    |                                                                            |
| Fan                            |                                    |                                                                            |

- 3 If a thermostat is set as subordinate, parameter P259 value needs to be set accordingly.

0.2.248 RDG204KN Room Thermostat > Basic Configuration

|                                |                                    |                                                                                                         |
|--------------------------------|------------------------------------|---------------------------------------------------------------------------------------------------------|
| Basic Configuration            | [DIP] Plant type                   | 2-pipe / 2 stage                                                                                        |
| Device                         | [P001] Control sequence            | Cooling only                                                                                            |
| Room Operating Mode            | [P258] Manager / Subordinate (M/S) | <input checked="" type="radio"/> Subordinate <input type="radio"/> Manager                              |
| Room Temperature and Setpoi... | [P259] Subordinate identification  | 1                                                                                                       |
| Controller                     | [P450] Control strategy            | <input type="radio"/> Temperature (T)<br><input checked="" type="radio"/> Temp. (T) + Air quality (IAQ) |
| Alarm                          |                                    |                                                                                                         |
| Inputs                         |                                    |                                                                                                         |
| Outputs                        |                                    |                                                                                                         |
| Fan                            |                                    |                                                                                                         |

#### Note

The following two M/S - manager/subordinate binding options are alternatives. They cannot be used together.

**M/S - manager/subordinate binding via P901 & P902**

4 Manager and subordinate binding is set using parameters P901 and P902.

- Binding setting on manager

--- RDG204KN Room Thermostat > Device

|                              |                                                   |                                                                                           |
|------------------------------|---------------------------------------------------|-------------------------------------------------------------------------------------------|
| Basic Configuration          | [P002] Operation via room operating mode selector | Auto - Protection                                                                         |
| Device                       | [P003] Operation via fan operating selector       | Auto - Manual                                                                             |
| Room Operating Mode          | [P004] Unit                                       | <input checked="" type="radio"/> Degrees Celsius <input type="radio"/> Degrees Fahrenheit |
| Room Temperature and Setp... | [P005] Scheduler                                  | <input checked="" type="radio"/> Disabled <input type="radio"/> Enabled                   |
| Room Indoor Air Quality      | [P008] Standard display                           | <input checked="" type="radio"/> Room temperature <input type="radio"/> Setpoint          |
| Controller                   | [P009] Additional display information             | -----                                                                                     |
| Alarm                        | [P017] Summer time                                | Europe                                                                                    |
| Inputs                       | [P028] Keypad                                     | Unlocked                                                                                  |
| Outputs                      | [P030] Buzzer function                            | <input type="radio"/> Disabled <input checked="" type="radio"/> Enabled                   |
| Fan                          | [P031] Language                                   | German                                                                                    |
|                              | [P500] NFC                                        | <input type="radio"/> Disabled <input checked="" type="radio"/> Enabled                   |
|                              | [P502] Password                                   | <input type="radio"/> Disabled <input checked="" type="radio"/> Enabled                   |
|                              | [P503] Password                                   | 0                                                                                         |
|                              | [P901] Geographical zone (apartment)              | 29                                                                                        |
|                              | [P902] Geographical zone (room)                   | 1                                                                                         |

- Binding setting on subordinate

--- RDG204KN Room Thermostat > Device

|                                |                                       |                                                                                           |
|--------------------------------|---------------------------------------|-------------------------------------------------------------------------------------------|
| Basic Configuration            | [P004] Unit                           | <input checked="" type="radio"/> Degrees Celsius <input type="radio"/> Degrees Fahrenheit |
| Device                         | [P008] Standard display               | <input checked="" type="radio"/> Room temperature <input type="radio"/> Setpoint          |
| Room Operating Mode            | [P009] Additional display information | -----                                                                                     |
| Room Temperature and Setpoi... | [P030] Buzzer function                | <input type="radio"/> Disabled <input checked="" type="radio"/> Enabled                   |
| Room Indoor Air Quality        | [P031] Language                       | German                                                                                    |
| Controller                     | [P500] NFC                            | <input type="radio"/> Disabled <input checked="" type="radio"/> Enabled                   |
| Alarm                          | [P502] Password                       | <input type="radio"/> Disabled <input checked="" type="radio"/> Enabled                   |
| Inputs                         | [P503] Password                       | 0                                                                                         |
| Outputs                        | [P901] Geographical zone (apartment)  | 29                                                                                        |
| Fan                            | [P902] Geographical zone (room)       | 1                                                                                         |

## M/S - manager/subordinate binding via communication objects

4 The M/S - manager/subordinate binding is set using communication objects, for object details, see Manager/subordinate communication in KNX S-Mode [→ 74].

|                   | S-Mode objects manager |                                               |   |       | S-Mode objects subordinate                     |  |
|-------------------|------------------------|-----------------------------------------------|---|-------|------------------------------------------------|--|
| Setpoint:         | [90]                   | Room temp: Current cooling setpoint (send)    | ➔ | [93]  | Room temp: Current cooling setpoint (receive)  |  |
|                   | [91]                   | Room temp: Current heating setpoint (send)    | ➔ | [92]  | Room temp: Current heating setpoint (receive)  |  |
|                   | [27]                   | Room temp: Comfort setpoint abs (send)        | ➔ | [26]  | Room temp: Comfort setpoint abs (receive)      |  |
| Room temperature: | [37]                   | Built-in room temperature value               | ➔ | [36]  | External room temperature value                |  |
| Room humidity:    | [77]                   | Built-in room relative humidity value [%r.h.] | ➔ | [78]  | External room relative humidity value [% r.h.] |  |
| Operation mode:   | [17]                   | Room operating mode: Status                   | ➔ | [94]  | Room operating mode: Status (receive)          |  |
| ChangeOverWater:  | [95]                   | ChangeOverWater status                        | ➔ | [96]  | ChangeOverWater status                         |  |
| Fan speed:        | [97]                   | Manual fan command value (send)               | ➔ | [52]  | Fan command value                              |  |
|                   | [51]                   | FanStatus                                     | ➔ | [50]  | FanManual                                      |  |
| Room air quality  | [100]                  | Built-in room air quality value               | ➔ | [101] | External room air quality value                |  |

- Binding setting on manager

|    |                                                  |         |                          |         |           |                                               |     |
|----|--------------------------------------------------|---------|--------------------------|---------|-----------|-----------------------------------------------|-----|
| 25 | Room temp: Comfort basic setpoint                | Receive | New group addre...0/3/25 | 2 bytes | C - W - U | temperature (°C)                              | Low |
| 26 | Room temp: Comfort setpoint abs (receive)        | Receive | New group addre...0/3/26 | 2 bytes | C - W - U | temperature (°C)                              | Low |
| 27 | Room temp: Comfort setpoint abs (send)           | Send    | New group addre...0/3/27 | 2 bytes | C R - T - | temperature (°C)                              | Low |
| 28 | Room temp: Current setpoint                      | Send    |                          | 2 bytes | C R - T - | temperature (°C)                              | Low |
| 29 | Setpoint heat set (receive)                      | Receive | New group addre...0/3/29 | 8 bytes | C - W - - | Temperature setpoint setting for 4 HVAC Modes | Low |
| 30 | Setpoint cool set (receive)                      | Receive | New group addre...0/3/30 | 8 bytes | C - W - - | Temperature setpoint setting for 4 HVAC Modes | Low |
| 31 | Setpoint heat set (send)                         | Send    |                          | 8 bytes | C R - T - | Temperature setpoint setting for 4 HVAC Modes | Low |
| 32 | Setpoint cool set (send)                         | Send    |                          | 8 bytes | C R - T - | Temperature setpoint setting for 4 HVAC Modes | Low |
| 33 | Room temperature: Comfort setpoint rel (receive) | Receive | New group addre...0/3/33 | 2 bytes | C - W - U | temperature difference (K)                    | Low |
| 34 | Room temperature: Comfort setpoint rel (send)    | Send    |                          | 2 bytes | C R - T - | temperature difference (K)                    | Low |
| 35 | Extended comfort mode status                     | Send    |                          | 1 bit   | C R - T - | state                                         | Low |
| 36 | External room temperature value                  | Receive | New group addre...0/3/36 | 2 bytes | C - W - U | temperature (°C)                              | Low |
| 37 | Built-in room temperature value                  | Send    | New group addre...0/3/37 | 2 bytes | C R - T - | temperature (°C)                              | Low |
| 38 | Frost alarm (0=No alarm/1=Alarm)                 | Send    |                          | 1 bit   | C R - T - | alarm                                         | Low |
| 39 | Heat alarm (0=No alarm/1=Alarm)                  | Send    |                          | 1 bit   | C R - T - | alarm                                         | Low |

- Binding setting on subordinate

| Number | Name                                      | Object Function | Description              | Group Adres | Length  | C | R | W | T | U | Data Type        | Priority |
|--------|-------------------------------------------|-----------------|--------------------------|-------------|---------|---|---|---|---|---|------------------|----------|
| 4      | Fault information                         | Send            |                          |             | 6 bytes | C | R | - | T | - | alarm info       | Alarm    |
| 5      | Fault status (0=No alarm/1=Alarm)         | Send            |                          |             | 1 bit   | C | R | - | T | - | alarm            | Low      |
| 6      | Fault transmission (0=Disable/1=Enable)   | Receive         |                          |             | 1 bit   | C | - | W | - | U | enable           | Low      |
| 26     | Room temp: Comfort setpoint abs (receive) | Receive         | New group addre...0/3/27 |             | 2 bytes | C | - | W | - | U | temperature (°C) | Low      |
| 36     | External room temperature value           | Receive         | New group addre...0/3/37 |             | 2 bytes | C | - | W | - | U | temperature (°C) | Low      |
| 40     | X1: Temperature [°C]                      | Send            |                          |             | 2 bytes | C | R | - | T | - | temperature (°C) | Low      |
| 41     | X1: Digital (0=Off/1=On)                  | Send            |                          |             | 1 bit   | C | R | - | T | - | switch           | Low      |
| 42     | X2: Temperature [°C]                      | Send            |                          |             | 2 bytes | C | R | - | T | - | temperature (°C) | Low      |



### 4.12.3 LTE-Mode

LTE-Mode was specifically designed to simplify engineering. Unlike with S-Mode, individual connections (group addresses) need not be created in the tool. The devices autonomously establish connections.

#### Definitions

The following circumstances are predefined:

- Every device or subdevice is located within a zone
- Every data point (input or output) is assigned to a zone
- Every data point (input or output) has a precisely defined "name"

Whenever an output and an input with the same "name" are located in the same zone, a connection is established automatically, as shown in the following diagram.

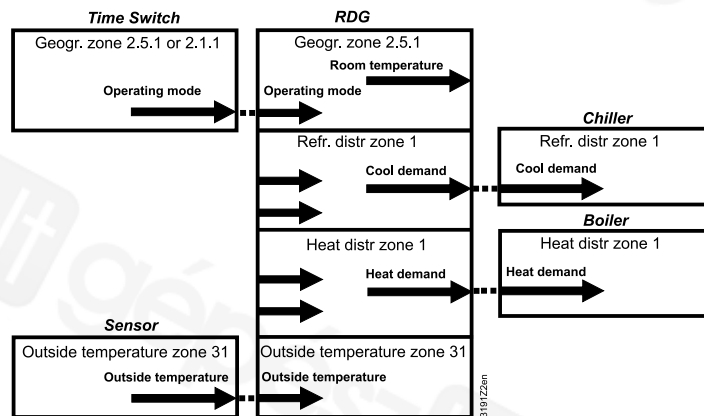

#### Engineering and commissioning

- For a detailed description of KNX (topology, bus supply, function and setting of LTE zones, filter tables, etc.), see "Communication via the KNX bus for Synco 700, 900 and RXB/RXL, Basic Documentation [→ 6]" [7]
- LTE-Mode data points and settings are described in the Synco Application Manual [→ 6] [14]
- To engineer and commission a specific system, use the Synco700 planning and commissioning protocol [→ 6] (XLS table in HIT, [8])

### 4.12.4 Zone addressing in LTE-Mode (with Synco)

Zone addresses must be allocated where RDG2..KN KNX room thermostats are used in LTE-Mode (e.g. in conjunction with Synco).

The following zone addresses must be defined together with the Synco devices at the planning stage based on application.

| Short description               | Factory setting     | Parameter |
|---------------------------------|---------------------|-----------|
| Geographical zone (apartment)   | -- (out of service) | P901      |
| Geographical zone (room)        | 1                   | P902      |
| Heat distr zone heating coil    | -- (out of service) | P903      |
| Refr distr zone cooling coil    | -- (out of service) | P904      |
| Heat distr zone heating surface | -- (out of service) | P905      |

#### Note

- "Subzone" of "Geographical zone" is fixed at 1 (not adjustable). The device sends and receives LTE communication signals only, if the zone address is valid (not OSV = not out of service).
- Both geographical zones P901 and P902 cannot be set to same value on two devices simultaneously.

The zones are defined as follows:

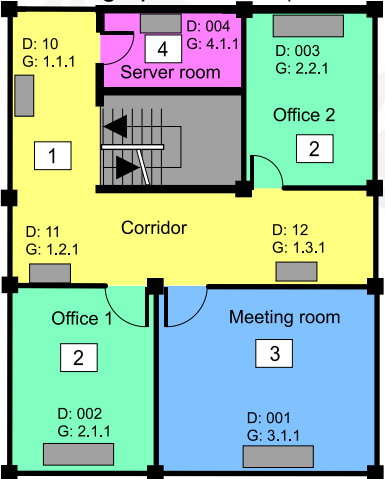
|                                                                                                                                                    |                                                                                                                                                                                                                                                                                                                                                                                                                                                                                                                                                                                                                                                                                                                                                                                                                                                                                                                                                                                                                                                                                                                                                                                                                                                                                                                                                                                                                                                                                         |
|----------------------------------------------------------------------------------------------------------------------------------------------------|-----------------------------------------------------------------------------------------------------------------------------------------------------------------------------------------------------------------------------------------------------------------------------------------------------------------------------------------------------------------------------------------------------------------------------------------------------------------------------------------------------------------------------------------------------------------------------------------------------------------------------------------------------------------------------------------------------------------------------------------------------------------------------------------------------------------------------------------------------------------------------------------------------------------------------------------------------------------------------------------------------------------------------------------------------------------------------------------------------------------------------------------------------------------------------------------------------------------------------------------------------------------------------------------------------------------------------------------------------------------------------------------------------------------------------------------------------------------------------------------|
| <p>Geographical zone<br/>(space zone)<br/>(Apartment . Room . Subzone)<br/>Apartment = ---, 1...126<br/>Room = ---, 1...63<br/>Subzone = fix 1</p> | <p>Zone where an RDG2..KN KNX room thermostat is physically located. Other room-specific devices may also be located in this zone. Information exchanged in this zone is related specifically to the device like operating mode, setpoints, room temperature, etc. The designations "Apartment", "Room" and "Subzone" are not necessarily literal. E.g., Apartment can be used to refer to a group of rooms, floor or section of a building. "Room", however, really does refer to a room. Subzone is not used for HVAC devices. It is more relevant to other disciplines, such as lighting. Subzone is fixed at "1" and not displayed. The schedule information is expected from the same zone where the thermostat is located (Residential).<br/>If no time switch information is received from the same zone, the thermostat uses the information received from the same apartment but with room "1" A.1.1 (Office).<br/><b>Example:</b><br/><b>Commercial building</b><br/>In a commercial building, the schedule information is sent by the RMB975 central control unit. The zones are divided into so called "Room groups" (e.g., 1...4), where each "Room group" can have an individual schedule. A room thermostat in the same "Room group" must have the same apartment address.<br/>Key:<br/>D = Device address (P900)<br/>G = Geographical zone (P901, P902) (Apartment.Room.Subzone)</p>  |
| <p>Heat distribution zone heating coil<br/>Zone = ---, 1...31</p>                                                                                  | <p>Information related specifically to the hot water system in heating coils is exchanged within this zone. The zone also includes a Synco device to process the information (e.g., RMH7xx or RMU7xx with changeover).</p>                                                                                                                                                                                                                                                                                                                                                                                                                                                                                                                                                                                                                                                                                                                                                                                                                                                                                                                                                                                                                                                                                                                                                                                                                                                              |
| <p>Heat distribution zone heating surface (radiator)<br/>Zone = ---, 1...31</p>                                                                    | <p>Information related specifically to the hot water system of a radiator is exchanged within this zone (e.g., heating demand). This zone also includes a Synco device to process the information (e.g., RMH7xx or RMB795B).</p>                                                                                                                                                                                                                                                                                                                                                                                                                                                                                                                                                                                                                                                                                                                                                                                                                                                                                                                                                                                                                                                                                                                                                                                                                                                        |
| <p>Refrigeration distribution zone cooling coil<br/>Zone = ---, 1...31</p>                                                                         | <p>Information related specifically to the chilled water system is exchanged within this zone (e.g., cooling demand). This zone also includes a Synco device to process the information (e.g., RMU7xx).</p>                                                                                                                                                                                                                                                                                                                                                                                                                                                                                                                                                                                                                                                                                                                                                                                                                                                                                                                                                                                                                                                                                                                                                                                                                                                                             |
| <p>Outside temperature zone<br/>Zone</p>                                                                                                           | <p>Outside temperature received in outside temperature zone 31 can be displayed on the room thermostat when commissioned accordingly (P009 = 2).</p>                                                                                                                                                                                                                                                                                                                                                                                                                                                                                                                                                                                                                                                                                                                                                                                                                                                                                                                                                                                                                                                                                                                                                                                                                                                                                                                                    |

### 4.12.5 M/S, Manager/subordinate configuration in LTE-Mode

- 1 In the ACS program, select **Plant** → **Open** to open the plant.
- 2 To open the parameter settings, select **Applications** → **Plant engineering**.

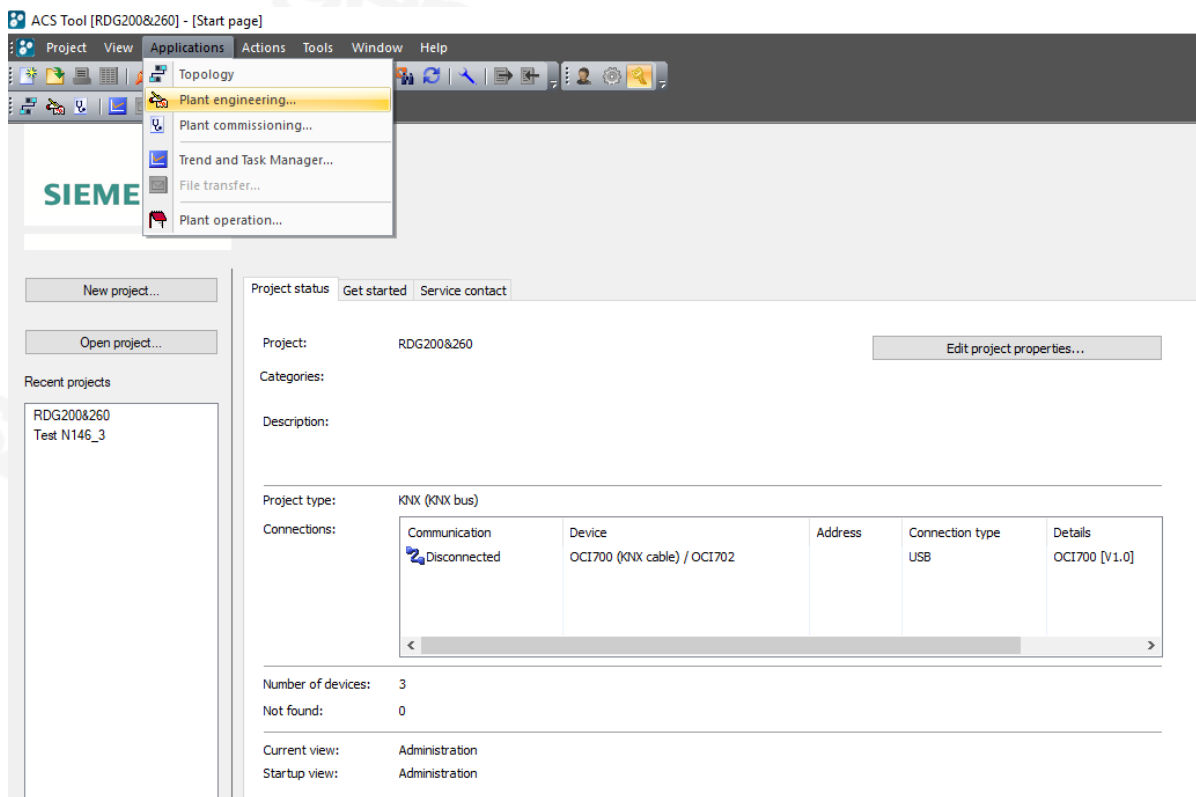

- 3 Select **Plant engineering** → **Device**, then set parameter P258 as **Manager** or **Subordinate**.

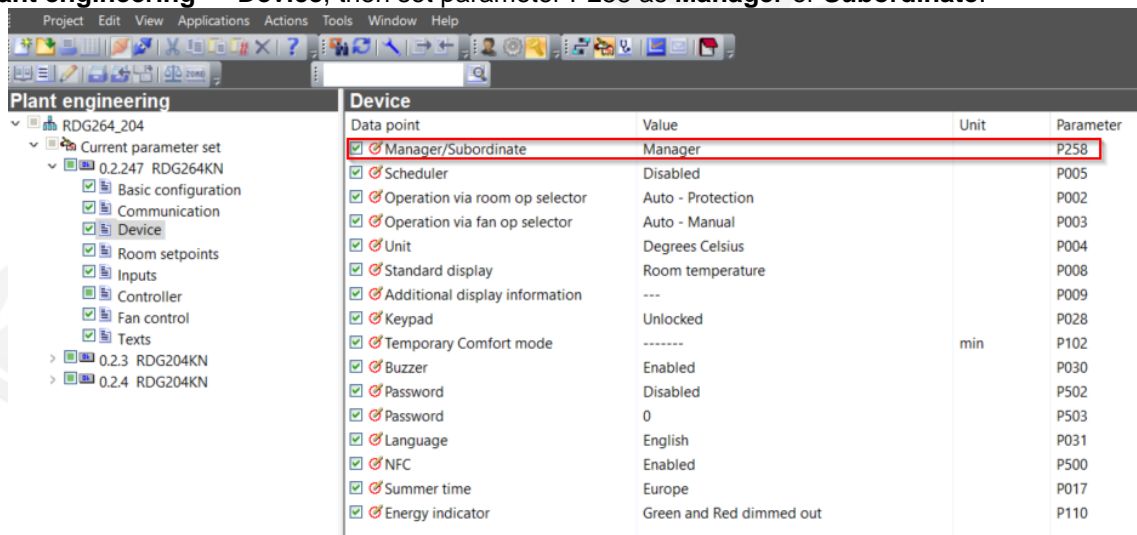

- 4 If the device is set as **Subordinate**, parameter P259 value needs to be set accordingly.

| Data point                                                         | Value            | Unit | Parameter |
|--------------------------------------------------------------------|------------------|------|-----------|
| <input checked="" type="checkbox"/> Manager/Subordinate            | Subordinate      |      | P258      |
| <input checked="" type="checkbox"/> Subordinate Identification     | 1                |      | P259      |
| <input checked="" type="checkbox"/> Unit                           | Degrees Celsius  |      | P004      |
| <input checked="" type="checkbox"/> Standard display               | Room temperature |      | P008      |
| <input checked="" type="checkbox"/> Additional display information | ---              |      | P009      |
| <input checked="" type="checkbox"/> Buzzer                         | Enabled          |      | P030      |
| <input checked="" type="checkbox"/> Password                       | Disabled         |      | P502      |
| <input checked="" type="checkbox"/> Password                       | 0                |      | P503      |
| <input checked="" type="checkbox"/> Language                       | English          |      | P031      |
| <input checked="" type="checkbox"/> NFC                            | Enabled          |      | P500      |

- 5 Select **Applications** → **Plant operation** → **Settings** → **Communication**, then set parameters P901 and P902.

| Data point                                                         | Value   | Unit | Parameter |
|--------------------------------------------------------------------|---------|------|-----------|
| <input checked="" type="checkbox"/> Geographical zone (apartment)  | 29      |      | P901      |
| <input checked="" type="checkbox"/> Geographical zone (room)       | 1       |      | P902      |
| <input checked="" type="checkbox"/> Heat distr zone heating coil   | -----   |      | P903      |
| <input checked="" type="checkbox"/> Refrig distr zone cooling coil | -----   |      | P904      |
| <input checked="" type="checkbox"/> Transformation Precomfort      | Economy |      | P910      |

| Data point                                                        | Value   | Unit | Parameter |
|-------------------------------------------------------------------|---------|------|-----------|
| <input checked="" type="checkbox"/> Geographical zone (apartment) | 29      |      | P901      |
| <input checked="" type="checkbox"/> Geographical zone (room)      | 1       |      | P902      |
| <input checked="" type="checkbox"/> Heat distr zone heating coil  | -----   |      | P903      |
| <input checked="" type="checkbox"/> Transformation Precomfort     | Economy |      | P910      |

### 4.12.6 Example of heating and cooling demand zones

The building is equipped with Synco controls on the generation side and RDF../RDG../RDG.. room thermostats on the room side.

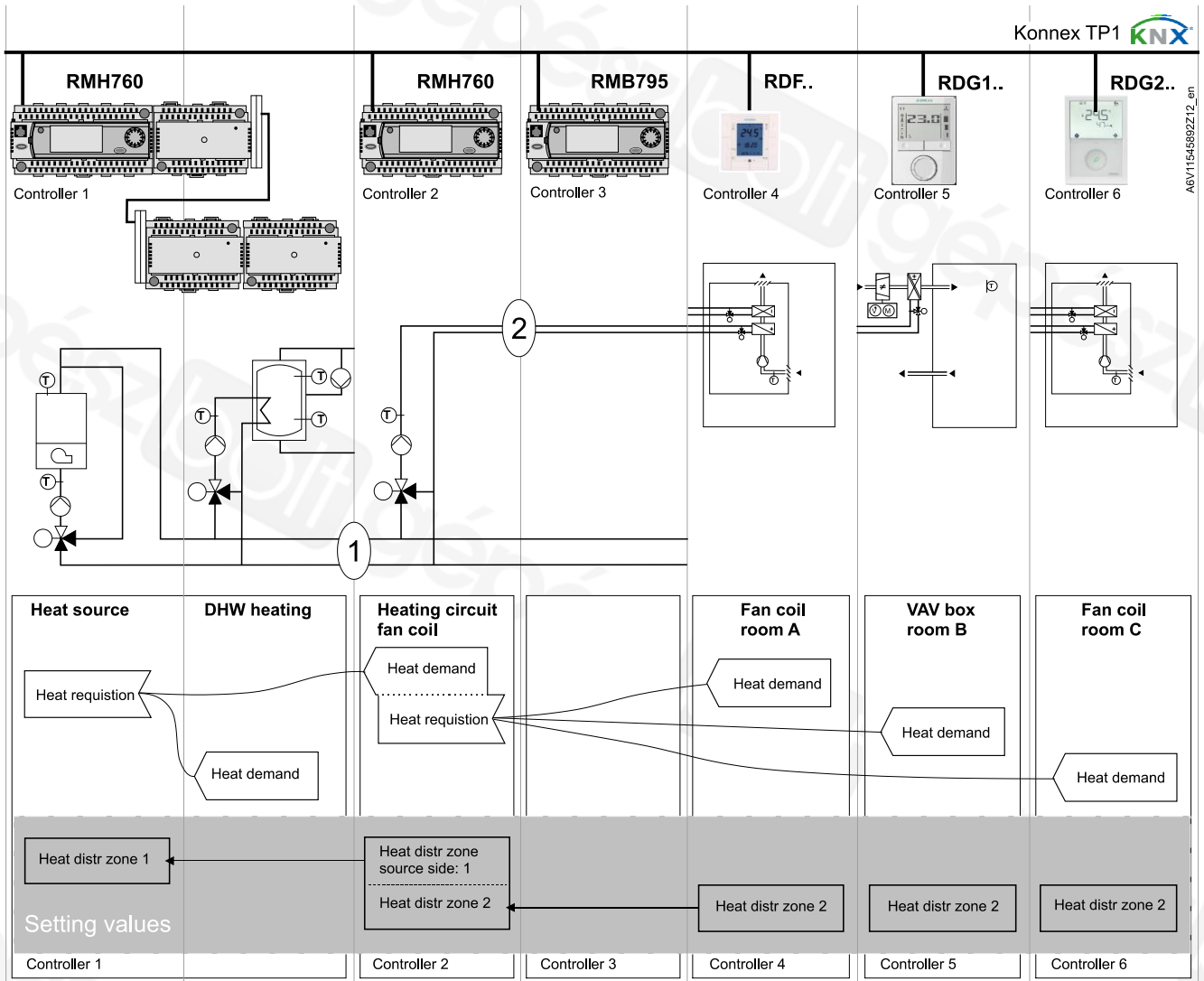

**Explanation relating to the illustration**

In the case of a typical application, the individual RDF../RDG.. room thermostats send their heat demand to the primary controller (in the above example to the RMH760).

(1) and (2) designate the numbers of the distribution zone.

**Notes**

- This type of application can also be applied to refrigeration distribution zones.
- If no 2-pipe fan coil unit is used, heat and refrigeration demand signals are sent simultaneously to the primary plant.

### 4.12.7 Send heartbeat and receive timeout

In a KNX network, S-Mode and LTE-Mode communication objects can be exchanged between individual devices. The "Receive timeout" defines the period of time within which all the communication objects requested from a device is received at least once. If a communication object is not received within this period, a predefined value is used.

Similarly, the "Send heartbeat" defines the period of time within which all the communication objects requested must be transmitted at least once.

#### LTE-Mode/S-Mode

Fixed times are specified as follows:

- Receive timeout: 31 minutes
- Send heartbeat: 15 minutes

| Object [KNX obj. no.]                      | I/O     | Minutes | Default value |
|--------------------------------------------|---------|---------|---------------|
| Room operating mode:<br>Time switch [13] * | Receive | 31      | Comfort       |
| Application mode [48]                      | Receive | 31      | Auto          |
| Heating/Cooling mode status<br>[46] *      | Receive | 31      | Heating       |

\* RDG2.. recognizes whether the devices have the heartbeat function. If yes, the two communication objects are set to the predefined object for a timeout. Otherwise, it retains the original value (COV) that RDG2.. receives for a timeout.

#### Reducing the bus load

Individual zones can also be disabled (out of service) via control parameter if they are not being used. In disabled zones, the LTE signal no longer sends periodically and therefore reduces bus load.

### 4.12.8 Startup

#### Startup response

The application is restarted after every reset, so that all the connected motorized valve actuators are synchronized (see Control outputs [→ 124]).

#### Startup delay

After a reset, it takes up to 5 minutes for all the connected room thermostats to restart. This is designed to avoid overloading the mains power supply when restarting. At the same time, it reduces the load on the KNX network, as not all thermostats transmit data at the same time. The delay ( $T_{\text{WaitDevice}}$ ) is determined by the thermostat's device address. The device starts to send after the delay.

### 4.12.9 Heating and cooling demand



Heating output primary  
Heating output secondary  
Cooling output primary  
Cooling output secondary

Together with Synco, the heating and/or cooling demand from each room is transmitted to the BACS to provide the required heating or cooling energy.

An example for LTE-Mode is described in Example of heating and cooling demand zones [→ 149].

In S-Mode, the current state signals of the control outputs are available.

### 4.12.10 Fault and alarms function on KNX

A fault is sent on the bus in the event of a fault occur (for example, digital fault input, Dewpoint, communication configuration, etc.).

An RDG2..KN room thermostat monitors the bus and sends its fault, if the fault has the highest alarm priority. This ensures that the management station does not miss any alarms.

The alarm with the highest priority is displayed first and sent over the bus if alarms occur at the same time.

Fault transmission is different in LTE-Mode and S-Mode:



| S-Mode                                   | LTE-Mode                                              |
|------------------------------------------|-------------------------------------------------------|
| Fault state                              | Alarm info (error code + internal information)        |
| Fault information (internal information) | Alarm text (default text can be edited with ACS tool) |

The table below shows the error code and default alarm texts.

| Priorities | Fault                          | Thermostat | Fault information on bus |                          |                               |
|------------|--------------------------------|------------|--------------------------|--------------------------|-------------------------------|
|            |                                | Display    | Error code               | Default fault text       | Text adjustable <sup>1)</sup> |
| -          | No fault                       | ---        | 0                        | No fault                 | ✓                             |
| 1          | Bus power supply <sup>2)</sup> | 🔔 BUS      | 5000                     | No bus power supply      | ---                           |
| 2          | Device address error           | 🔔 Addr     | 6001                     | >1 id device address     | ---                           |
| 3          | Condensation                   | 🔔 -💧 COND  | 4930                     | Condensation in the room | ✓                             |
| 4          | External fault input X1        | 🔔 AL1      | 9001                     | Fault input 1            | ✓                             |
| 5          | External fault input X2        | 🔔 AL2      | 9002                     | Fault input 2            | ✓                             |
| 6          | External fault input U1        | 🔔 AL3      | 9003                     | Fault input 3            | ✓                             |

| Priorities | Fault                    | Thermostat | Fault information on bus |                          |                               |
|------------|--------------------------|------------|--------------------------|--------------------------|-------------------------------|
|            |                          | Display    | Error code               | Default fault text       | Text adjustable <sup>1)</sup> |
| 7          | Clean filter reminder    | ▲ FIL      | 3911                     | Dirty filter             | ✓                             |
| 8          | Room sensor error        | Er1        | 60                       | Room sensor error        | ✓                             |
| 9          | Internal error           | Er2        | 1800                     | Internal error           | ✓                             |
| 10         | Sensor error input X1    | Er3        | 101                      | [N.X1] sensor error      | ✓                             |
| 11         | Sensor error input X2    | Er4        | 102                      | [N.X2] sensor error      | ✓                             |
| 12         | Sensor error input X3    | Er5        | 103                      | [N.X3] sensor error      | ✓                             |
| 13         | Air quality sensor error | Er6        | 87                       | Air quality sensor error | ✓                             |

<sup>1)</sup> Default alarm texts are stored in the thermostat's non-volatile memory and can be adjusted using the ACS commissioning tool.

<sup>2)</sup> This error is not sent over the bus (because there is no bus, not enough bus power supply, bus is overloaded or bus signal is distorted).

#### Priority of alarms

- Priority order is #1...7
- External faults #4...6: If faults are active, the display shows **AL1, AL2, AL3**, alternating. Only the fault with the highest priority is sent over the bus.

A supervisor alarm system may command the thermostat to stop sending faults to the bus via the communication object "Fault transmission" (disable/enable).

This has no impact on the local display of faults.

After a timeout of 48 hours, the sending of faults is automatically enabled again.





### 4.12.11 PL-Link integration in PXC 4, 5 and 7

Communication between PXC4, PXC5, and PXC7 automation stations and peripheral devices with KNX PL-Link has been optimized so that plug-and-play functionality is available offering automatic device recognition, device connection, and device configuration.

All communicating RDG2.. thermostats, with the following FW versions, support PL-Link integration into PXC4 / 5 / 7.

- RDG200KN...: FW Version  $\geq$ V5.6
- RDG260KN... FW Version  $\geq$ V5.6
- RDG204KN...: FW Version  $\geq$ V7.4
- RDG264KN... FW Version  $\geq$ V7.4

#### System characteristics

Desigo topology, refer to chap "2.5 Integration via KNX bus"

- With external KNX power supply, the system runs in maximum 64 KNX PL-Link nodes per KNX network and automation station.

#### RDG commissioning and integration

KNX PL-Link RDG are configured and commissioned by using the Desigo standard tool ABT Site and commissioning and support for service, ABT Go can be used.

Follow instructions and indications described in the Desigo documentation A6V13054432 and A6V13054435 for the integration.

Important for the commissioning workflow:

- Before commissioning, all RDG DIP switches must be set to OFF.
- RDG commissioning mobile app PCT Go cannot be used for the setting.
- Local parameter setting on RDG HMI is not allowed.
- Set the thermostat in programming mode (left and right buttons simultaneously for 6 seconds) for assigning with ABT Go

#### Assign KNX address

With the PL-Link integration into PXC4, 5 and 7, KNX address is assigned and set automatically via system.

#### KNX PL-Link test mode (on RDG)

KNX PL-Link test mode helps check PL-Link connection of the thermostat.

Touch both left and middle buttons simultaneously to activate PL-Link test mode, indicated on the display by **TEST**.

Press button **✓** to activate a new test: If PXC connection succeed, **OK** displays; otherwise, **FAIL**. Or Press button **↵** (Esc) to exit the mode.

#### ABT Site terminology

Desigo uses a slightly different terminology than Synco RDG and mobile app PCT Go. The major deviations are for the configuration of the multifunctional inputs (parameters P151, P153 and P155).

The parameter table in Expert level parameters with diagnostics and test [→ 167] shows the terminology for Desigo and Synco for the setting of the multifunctional inputs.

**Restrictions**

The first PL-link integration does not support all RDG features, which will be enhanced in future upgrades.

|    |                                                                                                                                                                                                                                                                                                                                                                                                                                                                                                                                                                                                                     |
|----|---------------------------------------------------------------------------------------------------------------------------------------------------------------------------------------------------------------------------------------------------------------------------------------------------------------------------------------------------------------------------------------------------------------------------------------------------------------------------------------------------------------------------------------------------------------------------------------------------------------------|
| 1) | <b>Manager / Subordinate (M/S) on all RDG2..KN...</b> <ul style="list-style-type: none"> <li>M/S function is not supported by geographical zone.<br/>You may use mapping functions in ABT Site programming instead of coordinating multiple RDG's.</li> </ul>                                                                                                                                                                                                                                                                                                                                                       |
| 2) | <b>On RDG260KN (FW V5.6), hydraulic balancing on 6-port PICV application</b> <ul style="list-style-type: none"> <li>Setting parameters P260, P261 via ABT Site is not available.</li> </ul> <p>Solution:</p> <p>a) Update RDG260KN.. to FW version <math>\geq</math> V5.7 or</p> <p>b) When RDG260KN FW V5.6 has been commissioned via ABT Site, the hydraulic balancing parameters P260, P261 need to be set up on RDG260.. locally via mobile app PCT Go.</p> <p>Note, that after a device reset (P506) on RDG or after uploading changes from ABT project, P260 and P261 need to be re-adjusted accordingly.</p> |

## 4.13 Communication objects (RDG2..KN)

### 4.13.1 Overview



| Object No. and name                                                            | Thermostat | Object No. and name                                                            |
|--------------------------------------------------------------------------------|------------|--------------------------------------------------------------------------------|
|                                                                                | RDG        |                                                                                |
| 1 System time                                                                  | ➡          | ➡ 4 Fault information                                                          |
| 2 Date                                                                         | ➡          | ➡ 5 Fault status (0 = No alarm / 1 = Alarm)                                    |
| 3 Time of day                                                                  | ➡          |                                                                                |
|                                                                                |            | ➡ 8 Room operating mode: Preselection                                          |
| 6 Fault transmission (0 = Disable / 1 = Enable)                                | ➡          |                                                                                |
| 94 Room operating mode: Status (receive)                                       | ➡          | ➡ 17 Room operating mode: Status                                               |
| 7 Room operating mode: Preselection (receive)                                  | ➡          |                                                                                |
| 9 Room operating mode: Preselection Auto                                       | ➡          | ➡ 18 Room operating mode: Comfort status                                       |
| 10 Room operating mode: Preselection Comfort                                   | ➡          | ➡ 19 Room operating mode: Economy status                                       |
| 11 Room operating mode: Preselection Economy                                   | ➡          | ➡ 20 Room operating mode: Protection status                                    |
| 12 Room operating mode: Preselection Protection                                | ➡          |                                                                                |
| 13 Room operating mode: Time switch                                            | ➡          | ➡ 27 Room temp: Comfort setpoint abs (send)                                    |
| 14 Room operating mode: Time switch Comfort                                    | ➡          | ➡ 28 Room temp: Current setpoint                                               |
| 15 Room operating mode: Time switch Economy                                    | ➡          | ➡ 31 Setpoint heat set (send)                                                  |
| 16 Room operating mode: Time switch Protection                                 | ➡          | ➡ 32 Setpoint cool set (send)                                                  |
|                                                                                |            | ➡ 34 Room temperature: Comfort setpoint rel (send)                             |
| 21 Room temp: [P19] Economy heating setpoint                                   | ➡          | ➡ 35 Extended comfort mode status                                              |
| 22 Room temp: [P20] Economy cooling setpoint                                   | ➡          | ➡ 37 Built-in room temperature value                                           |
| 23 Room operating mode: Window contact (0 = Close / 1 = Open)                  | ➡          | ➡ 38 Frost alarm (0 = No alarm / 1 = Alarm)                                    |
| 24 Room operating mode: Presence detector (0 = NotOccupied / 1 = Occupied)     | ➡          | ➡ 39 Heat alarm (0 = No alarm / 1 = Alarm)                                     |
| 25 Room temp: Comfort basic setpoint                                           | ➡          | ➡ 40 X1: Temperature [°C]                                                      |
| 26 Room temp: Comfort setpoint abs (receive)                                   | ➡          | ➡ 41 X1: Digital (0 = Off / 1 = On)                                            |
|                                                                                |            | ➡ 42 X2: Temperature [°C]                                                      |
| 29 Setpoint heat set (receive)                                                 | ➡          | ➡ 43 X2: Digital (0 = Off / 1 = On)                                            |
| 30 Setpoint cool set (receive)                                                 | ➡          | ➡ 44 U1: Temperature [°C]                                                      |
| 33 Room temperature: Comfort setpoint rel (receive)                            | ➡          | ➡ 45 U1: Digital (0 = Off / 1 = On)                                            |
|                                                                                |            |                                                                                |
| 36 External room temperature value                                             | ➡          | ➡ 47 Heating/Cooling mode status (1 = Heating / 0 = Cooling) (send)            |
|                                                                                |            |                                                                                |
| 46 Heating/Cooling mode status (1 = Heating / 0 = Cooling) (receive)           | ➡          | ➡ 51 Fan operation (0 = Auto / 1 = Manual)                                     |
|                                                                                |            |                                                                                |
| 48 Application mode                                                            | ➡          | ➡ 53 Fan output                                                                |
| 49 Dew point alarm (0 = No alarm / 1 = Alarm)                                  | ➡          | ➡ 57 Fan speed 1 (0 = Off / 1 = On)                                            |
| 50 Enable fan command value (0 = Disable / 1 = Enable)                         | ➡          | ➡ 58 Fan speed 2 (0 = Off / 1 = On)                                            |
|                                                                                |            | ➡ 59 Fan speed 3 (0 = Off / 1 = On)                                            |
| 52 Fan command value                                                           | ➡          |                                                                                |
|                                                                                |            | ➡ 61 Heating, control value continuous                                         |
| 54 Fan speed 1 (0 = Off / 1 = On)                                              | ➡          | ➡ 62 Heating, control value continuous, seq 2                                  |
| 55 Fan speed 2 (0 = Off / 1 = On)                                              | ➡          | ➡ 63 Cooling, control value continuous                                         |
| 56 Fan speed 3 (0 = Off / 1 = On)                                              | ➡          | ➡ 64 Cooling, control value continuous, seq 2                                  |
| 60 Outside temperature                                                         | ➡          | ➡ 65 Heating, control value status (0 = Inactive / 1 = Active)                 |
|                                                                                |            | ➡ 66 Heating, control value status seq 2 (0 = Inactive / 1 = Active)           |
| 76 Enable electric heater (0 = Disable / 1 = Enable)                           | ➡          | ➡ 67 Cooling, control value status (0 = Inactive / 1 = Active)                 |
|                                                                                |            | ➡ 68 Cooling, control value status seq 2 (0 = Inactive / 1 = Active)           |
| 78 External room relative humidity value [% r.h.]                              | ➡          | ➡ 69 Heating or cooling, control value status (0 = Inactive / 1 = Active)      |
| 79 Room rel. humidity: Setpoint high                                           | ➡          | ➡ 70 Heating or cooling, control value status seq2 (0 = Inactive / 1 = Active) |
|                                                                                |            |                                                                                |
| 106 Room rel. humidity setpoint high Eco                                       | ➡          |                                                                                |
| 80 Room rel. humidity: Setpoint low                                            | ➡          | ➡ 71 Heating or cooling, control value continuous                              |
| 81 Reset the Energy efficiency status (Green leaf) (0 = No action / 1 = Reset) | ➡          | ➡ 72 Heating or cooling, control value continuous seq 2                        |
| 83 Enable or disable Leaf indication (0 = Disable / 1 = Enable)                | ➡          | ➡ 73 Control dehumidification (0 = Inactive / 1 = Active)                      |
| 84 Keypad: Lock fan speed                                                      | ➡          | ➡ 74 Control humidification (0 = Inactive / 1 = Active)                        |
| 85 Keypad: Lock fan speed in "auto" mode                                       | ➡          | ➡ 75 Hum. Control mode (inactive/hum/dehum)                                    |
| 86 Keypad: Lock the setpoint shift                                             | ➡          |                                                                                |
| 87 Keypad: Lock the operating mode                                             | ➡          | ➡ 77 Built-in room relative humidity value [%r.h.]                             |
|                                                                                |            |                                                                                |
|                                                                                |            | ➡ 82 Energy efficiency status / Green Leaf (0 = Green / 1 = Red)               |
|                                                                                |            |                                                                                |
|                                                                                |            | ➡ 89 Room operating mode: Window contact (0=Close/1=Open)                      |
|                                                                                |            | ➡ 88 Room operating mode: Presence detector (0=NotOccupied/1=Occupied)         |
| 92 Room temp: Current heating setpoint (receive)                               | ➡          | ➡ 91 Room temp: Current heating setpoint (send)                                |
| 93 Room temp: Current cooling setpoint (receive)                               | ➡          | ➡ 90 Room temp: Current cooling setpoint (send)                                |
| 96 ChangeOverWater status (1=Heating/0=Cooling) (receive)                      | ➡          | ➡ 95 ChangeOverWater status (1=Heating/0=Cooling) (send)                       |
|                                                                                |            | ➡ 97 Manual fan command value (send)                                           |
| 98 DC fan speed: [P359] Maximum speed heating                                  | ➡          |                                                                                |
| 99 DC fan speed: [P360] Maximum speed cooling                                  | ➡          |                                                                                |
| 101 External room air quality value                                            | ➡          |                                                                                |
|                                                                                |            | ➡ 100 Built-in room air quality value                                          |
|                                                                                |            | ➡ 102 DC damper demand                                                         |
|                                                                                |            | ➡ 103 On/Off damper demand                                                     |
| 104 PICV heating maximal position [P260]                                       | ➡          |                                                                                |
| 105 PICV cooling maximal position [P261]                                       | ➡          |                                                                                |
| 107 Room air quality: Setpoint [ppm] [P023]                                    | ➡          |                                                                                |
| 108 Minimum damper position [%] [P455]                                         | ➡          |                                                                                |
| 109 Maximum damper position [%] [P457]                                         | ➡          |                                                                                |
| Input communication object ➡                                                   |            | ➡ Output communication object                                                  |

### 4.13.2 Description of communication objects

| Obj                                                                                                                                                                                                                                                                                                                                                                | Object name                                        | Function                                             | Type/<br>length    | Flags |
|--------------------------------------------------------------------------------------------------------------------------------------------------------------------------------------------------------------------------------------------------------------------------------------------------------------------------------------------------------------------|----------------------------------------------------|------------------------------------------------------|--------------------|-------|
| 1                                                                                                                                                                                                                                                                                                                                                                  | <b>System time</b>                                 | Time and date                                        | 19.001<br>8 bytes  | CWU   |
| System time for display on the room thermostat. See P009 (3 or 4)                                                                                                                                                                                                                                                                                                  |                                                    |                                                      |                    |       |
| 2                                                                                                                                                                                                                                                                                                                                                                  | <b>Date</b>                                        | Date                                                 | 11.001<br>3 bytes  | CWU   |
| Day, month and year for display on the room thermostat. See P009 (3 or 4)                                                                                                                                                                                                                                                                                          |                                                    |                                                      |                    |       |
| 3                                                                                                                                                                                                                                                                                                                                                                  | <b>Time of day</b>                                 | Time of day                                          | 10.001<br>3 bytes  | CWU   |
| Another object for receiving the time of day for display on the room thermostat. See P009 (3 or 4)                                                                                                                                                                                                                                                                 |                                                    |                                                      |                    |       |
| 4                                                                                                                                                                                                                                                                                                                                                                  | <b>Fault information</b>                           | Alarm Info                                           | 219.001<br>6 bytes | CRT   |
| Common alarm output. If an alarm occurs, the alarm number is transmitted.                                                                                                                                                                                                                                                                                          |                                                    |                                                      |                    |       |
| 5                                                                                                                                                                                                                                                                                                                                                                  | <b>Fault status</b>                                | Alarm                                                | 1.005<br>1 bit     | CRT   |
| Common alarm output. If an alarm occurs, the alarm flag is set.                                                                                                                                                                                                                                                                                                    |                                                    |                                                      |                    |       |
| 6                                                                                                                                                                                                                                                                                                                                                                  | <b>Fault transmission</b>                          | Disable<br>Enable                                    | 1.003<br>1 bit     | CWU   |
| A supervisory alarm system can disable the broadcasting of alarms sent by the devices. This has no impact on the local display of alarms. After a timeout of 48 hours, the sending of faults is automatically enabled again.                                                                                                                                       |                                                    |                                                      |                    |       |
| 7                                                                                                                                                                                                                                                                                                                                                                  | <b>Room operating mode: Preselection (receive)</b> | Auto<br>Comfort<br>PreComf.<br>Economy<br>Protection | 20.102<br>1 byte   | CWU   |
| Controls the room operating mode selection of the thermostat (Manager) via bus.<br>The command can also be submitted as four 1-bit communication objects (9...12). The last interaction wins – either from local operating mode button or via bus.<br><b>Note:</b> The thermostat will transform Pre-Comfort either into Economy or Comfort (selectable via P910). |                                                    |                                                      |                    |       |
| 8                                                                                                                                                                                                                                                                                                                                                                  | <b>Room operating mode: Preselection (send)</b>    | Auto<br>Comfort<br>Economy<br>Protection             | 20.102<br>1 byte   | CRT   |
| Sends the room operating mode selection of the thermostat (Manager) via bus.<br>The command can also be submitted as four 1-bit communication objects (9...12). The last interaction wins – either from local operating mode button or via bus.                                                                                                                    |                                                    |                                                      |                    |       |

| Obj                                                                                                                                                                                                                                                                                                                                                                                          | Object name                                                                       | Function                                     | Type/<br>length  | Flags |
|----------------------------------------------------------------------------------------------------------------------------------------------------------------------------------------------------------------------------------------------------------------------------------------------------------------------------------------------------------------------------------------------|-----------------------------------------------------------------------------------|----------------------------------------------|------------------|-------|
| 9<br>10<br>11<br>12                                                                                                                                                                                                                                                                                                                                                                          | <b>Room operating mode: Preselection - Auto - Comfort - Economy - Protection</b>  | Trigger                                      | 1.017<br>1 bit   | CW    |
| Switch room operating mode of manager to either Auto, Comfort, Economy or Protection.<br>The last interaction wins – either from the local operating mode button or via bus.                                                                                                                                                                                                                 |                                                                                   |                                              |                  |       |
| 13                                                                                                                                                                                                                                                                                                                                                                                           | <b>Room operating mode: Time switch</b>                                           | Comfort<br>PreComf.<br>Economy<br>Protection | 20.102<br>1 byte | CWU   |
| This information is provided by a central schedule or a supervisor and defines the actual HVAC operating mode of manager.<br>The command can also be submitted via three 1-bit communication objects (14...16).<br>Protection has the highest priority and cannot be overridden.<br><b>Note:</b> The thermostat transforms Pre-Comfort either into Economy or Comfort (selectable via P910). |                                                                                   |                                              |                  |       |
| 14<br>15<br>16                                                                                                                                                                                                                                                                                                                                                                               | <b>Room operating mode: Time switch - Comfort - Economy - Protection</b>          | Trigger                                      | 1.017<br>1 bit   | CW    |
| Switch the HVAC mode to either Comfort, Economy or Protection mode of manager.                                                                                                                                                                                                                                                                                                               |                                                                                   |                                              |                  |       |
| 17                                                                                                                                                                                                                                                                                                                                                                                           | <b>Room operating mode: Status</b>                                                | Comfort<br>Economy<br>Protection             | 20.102<br>1 byte | CRT   |
| Actual room operating mode used by the thermostat (Manager) (considering time switch, user selection, window contact, etc.) This state information is available via one 8-bit enumeration or three 1-bit communication objects (18...20).                                                                                                                                                    |                                                                                   |                                              |                  |       |
| 18<br>19<br>20                                                                                                                                                                                                                                                                                                                                                                               | <b>Room operating mode: - Comfort status - Economy status - Protection status</b> | ON<br>OFF                                    | 1.011<br>1 bit   | CRT   |
| Corresponding communication object of manager sends "True".                                                                                                                                                                                                                                                                                                                                  |                                                                                   |                                              |                  |       |

| Obj                                                                                                                                                                                                                                                                                                                                                                                                                                                                                                                                                                                                                                                                                        | Object name                                              | Function               | Type/<br>length  | Flags |
|--------------------------------------------------------------------------------------------------------------------------------------------------------------------------------------------------------------------------------------------------------------------------------------------------------------------------------------------------------------------------------------------------------------------------------------------------------------------------------------------------------------------------------------------------------------------------------------------------------------------------------------------------------------------------------------------|----------------------------------------------------------|------------------------|------------------|-------|
| 21                                                                                                                                                                                                                                                                                                                                                                                                                                                                                                                                                                                                                                                                                         | <b>Room temp: [P19]<br/>Economy heating<br/>setpoint</b> | Temperature            | 9.001<br>2 bytes | CW    |
| <p>Communication object adjusts the Economy heating setpoint used by the thermostat (Manager) (see Setting and adjusting setpoints [→ 42]). It directly changes the value of the local parameter "Economy heating setpoint" P019.<br/>The range is --- (0), 5 °C...P020 (or max. 40 °C).<br/>S-Mode object needs to be enabled by setting <b>Room temperature: Economy Setpoint to as group object</b> in ETS.<br/>The Economy heating setpoint is stored in EEPROM. The service life of the EEPROM depends on the number of write cycles. Never write this communication object cyclically.</p>                                                                                           |                                                          |                        |                  |       |
| 22                                                                                                                                                                                                                                                                                                                                                                                                                                                                                                                                                                                                                                                                                         | <b>Room temp: [P20]<br/>Economy cooling<br/>setpoint</b> | Temperature            | 9.001<br>2 bytes | CW    |
| <p>Communication object adjusts the Economy cooling setpoint used by the thermostat (Manager) (see Setting and adjusting setpoints [→ 42]). It directly changes the value of the local parameter "Economy cooling setpoint" P020.<br/>The range is --- (0), P019 (min. 5 °C)...40 °C.<br/>S-Mode object needs to be enabled by setting <b>Room temperature: Economy Setpoint to as group object</b> in ETS.<br/>The Economy cooling setpoint is stored in EEPROM. The service life of the EEPROM depends on the number of write cycles. Never write this communication object cyclically.</p>                                                                                              |                                                          |                        |                  |       |
| 23                                                                                                                                                                                                                                                                                                                                                                                                                                                                                                                                                                                                                                                                                         | <b>Room operating<br/>mode: Window<br/>contact</b>       | Open<br>Closed         | 1.019<br>1 bit   | CWU   |
| <p>The RDG2..KN operating mode of manager is set to Protection if value "1" (open) is received and switches back to the previous mode for value "0" (closed). The "Window contact" is sent e.g. by a KNX switch and has the same effect as local window contact X1, X2 or U1 (P150, P153 or P155). Only one input source required either a local input X1/X2/U1 or KNX bus.</p>                                                                                                                                                                                                                                                                                                            |                                                          |                        |                  |       |
| 24                                                                                                                                                                                                                                                                                                                                                                                                                                                                                                                                                                                                                                                                                         | <b>Room operating<br/>mode: Presence<br/>detector</b>    | Occupied<br>Unoccupied | 1.018<br>1 bit   | CWU   |
| <p>Standard presence: The thermostat (Manager) is set to Comfort mode if value "1" (occupied) is received. It switches back to previous operating mode when the value is "0" (unoccupied). "Presence detector" is sent via KNX. It has the same effect as the local presence detector function on X1, X2, U1 (parameter P150, P153, P155).<br/>Only one input source must be used, either local input X1/X2/U1 or KNX bus.</p>                                                                                                                                                                                                                                                             |                                                          |                        |                  |       |
| 25                                                                                                                                                                                                                                                                                                                                                                                                                                                                                                                                                                                                                                                                                         | <b>Room temp:<br/>Comfort basic<br/>setpoint</b>         | Temperature            | 9.001<br>2 bytes | CWU   |
| <p>If function "Temporary comfort setpoint" is enabled via P103, once operating mode of manager is changed, the setpoint adjustments made by the user and via communication object 25 are dismissed. Then the thermostat is reset to the Comfort basic setpoint.<br/>The range is 5...40 °C.<br/><b>Note:</b> Setpoints that have been changed via the local HMI may be overwritten during a system startup from a central manager controller, e.g., RMB795B.<br/>The Comfort basic setpoint is stored in EEPROM (see Setting and adjusting setpoints [→ 42]). The service life of the EEPROM depends on the number of write cycles. Never write this communication object cyclically.</p> |                                                          |                        |                  |       |

| Obj                                                                                                                                                                                                                                                                                                                                                                               | Object name                                                         | Function                                               | Type/<br>length    | Flags |
|-----------------------------------------------------------------------------------------------------------------------------------------------------------------------------------------------------------------------------------------------------------------------------------------------------------------------------------------------------------------------------------|---------------------------------------------------------------------|--------------------------------------------------------|--------------------|-------|
| 26                                                                                                                                                                                                                                                                                                                                                                                | <b>Room temp:<br/>Comfort setpoint<br/>abs (receive)</b>            | Temperature                                            | 9.001<br>2 bytes   | CWU   |
| <p>Communication object shifts the setpoint (absolute) used by the thermostat (Manager) received via bus (see Setting and adjusting setpoints [→ 42]). The priority is same as local setpoint shift on the thermostat. The last selected option is always used.<br/>The range is 5...40 °C.<br/><b>Note:</b> The Comfort basic setpoint (object 25) will not be changed.</p>      |                                                                     |                                                        |                    |       |
| 27                                                                                                                                                                                                                                                                                                                                                                                | <b>Room temp:<br/>Comfort setpoint<br/>abs (send)</b>               | Temperature                                            | 9.001<br>2 bytes   | CRT   |
| <p>Sends the current Comfort absolute setpoint value used in the RDG2..KN (Manager) (see Setting and adjusting setpoints [→ 42]).</p>                                                                                                                                                                                                                                             |                                                                     |                                                        |                    |       |
| 28                                                                                                                                                                                                                                                                                                                                                                                | <b>Room temp:<br/>Current setpoint</b>                              | Temperature                                            | 9.001<br>2 bytes   | CRT   |
| <p>Current setpoint, including shift, compensation, etc., used by the thermostat (Manager) for temperature control.</p>                                                                                                                                                                                                                                                           |                                                                     |                                                        |                    |       |
| 29<br>30                                                                                                                                                                                                                                                                                                                                                                          | <b>Setpoint<br/>heat set (receive)<br/>cool set (receive)</b>       | Temperature<br>setpoint setting<br>for 4 HVAC<br>modes | 275.100<br>8 bytes | CW    |
| <p>Receive a set of all cool / heat setpoints for all modes of manager. (Comfort, Pre-Comfort, Economy and Protection: All setpoints range is 5...40 °C.)<br/>Depending on selected application, the relevant setpoint of only heating / only cooling / heating and cooling will be stored accordingly.<br/>Heating setpoint value must be lower than cooling setpoint value.</p> |                                                                     |                                                        |                    |       |
| 31<br>32                                                                                                                                                                                                                                                                                                                                                                          | <b>Setpoint<br/>heat set (send)<br/>cool set (send)</b>             | Temperature<br>setpoint setting<br>for 4 HVAC<br>modes | 275.100<br>8 bytes | CRT   |
| <p>Send a set of cool / heat setpoints used in the device for all modes of manager. (Comfort, Economy and Protection)<br/>Depending on selected application, the relevant setpoint of only heating / only cooling / heating and cooling will be sent accordingly.</p>                                                                                                             |                                                                     |                                                        |                    |       |
| 33                                                                                                                                                                                                                                                                                                                                                                                | <b>Room<br/>temperature:<br/>Comfort setpoint<br/>rel (receive)</b> | Temperature                                            | 9.002<br>2 bytes   | CWU   |
| <p>Communication object shifts the setpoint (relative) used by the thermostat (Manager) (see Setting and adjusting setpoints [→ 42]). The priority is same as local setpoint shift on the thermostat. The last selected option is always used.<br/>The range is -3 K...+3 K.<br/><b>Note:</b> The Comfort basic setpoint (object 25) will not be changed.</p>                     |                                                                     |                                                        |                    |       |
| 34                                                                                                                                                                                                                                                                                                                                                                                | <b>Room<br/>temperature:<br/>Comfort setpoint<br/>rel (send)</b>    | Temperature                                            | 9.002<br>2 bytes   | CRT   |
| <p>Sends the current Comfort relative setpoint value used in the RDG2..KN (Manager) (see Setting and adjusting setpoints [→ 42]).<br/>The range is -3 K...+3 K.<br/><b>Note:</b> The Comfort basic setpoint (object 25) will not be changed.<br/>The object works only when Comfort setpoint is set.</p>                                                                          |                                                                     |                                                        |                    |       |

| Obj                                                                                                                                                                                                                                                                     | Object name                                                    | Function                 | Type/<br>length  | Flags |
|-------------------------------------------------------------------------------------------------------------------------------------------------------------------------------------------------------------------------------------------------------------------------|----------------------------------------------------------------|--------------------------|------------------|-------|
| 35                                                                                                                                                                                                                                                                      | <b>Extended comfort mode status</b>                            | ON<br>OFF                | 1.011<br>1 bit   | CRT   |
| Indicates the status of Comfort mode extension of manager.                                                                                                                                                                                                              |                                                                |                          |                  |       |
| 36                                                                                                                                                                                                                                                                      | <b>External room temperature value</b>                         | Temperature              | 9.001<br>2 bytes | CWU   |
| The thermostat receives and works with the room temperature from an external sensor.                                                                                                                                                                                    |                                                                |                          |                  |       |
| 37                                                                                                                                                                                                                                                                      | <b>Built-in room temperature value</b>                         | Temperature              | 9.001<br>2 bytes | CRT   |
| The value of the room temperature measured via built-in sensor or external sensor is available on bus.                                                                                                                                                                  |                                                                |                          |                  |       |
| 38                                                                                                                                                                                                                                                                      | <b>Frost alarm</b>                                             | No alarm<br>Alarm        | 1.005<br>1 bit   | CRT   |
| Sends an alarm if the room temperature is below the frost alarm setting.                                                                                                                                                                                                |                                                                |                          |                  |       |
| 39                                                                                                                                                                                                                                                                      | <b>Heat alarm</b>                                              | No alarm<br>Alarm        | 1.005<br>1 bit   | CRT   |
| Sends an alarm if the room temperature is above the heat alarm setting.                                                                                                                                                                                                 |                                                                |                          |                  |       |
| 40<br>42<br>44                                                                                                                                                                                                                                                          | <b>X1: Temperature<br/>X2: Temperature<br/>U1: Temperature</b> | Temperature              | 9.001<br>2 bytes | CRT   |
| Indicate the values of the temperature sensors connected to the local inputs X1/X2/U1                                                                                                                                                                                   |                                                                |                          |                  |       |
| 41<br>43<br>45                                                                                                                                                                                                                                                          | <b>X1: Digital<br/>X2: Digital<br/>U1: Digital</b>             | OFF<br>ON                | 1.001<br>1 bit   | CRT   |
| Indicate the status of the digital inputs (adjusted by P151/P154/P156) including considering of operating action                                                                                                                                                        |                                                                |                          |                  |       |
| 46                                                                                                                                                                                                                                                                      | <b>Heating/Cooling changeover (receive)</b>                    | Heating: 1<br>Cooling: 0 | 1.100<br>1 bit   | CWU   |
| Changeover information received via bus.<br>Default: Current mode before power down.<br>The same function is also available via local multifunctional input X1/X2/U1 (P150, P153, P155).<br>Only one input source must be used, either local input X1/X2/U1 or KNX bus. |                                                                |                          |                  |       |
| 47                                                                                                                                                                                                                                                                      | <b>Heating/Cooling mode status (send)</b>                      | Heating: 1<br>Cooling: 0 | 1.100<br>1 bit   | CRT   |
| Sends the current heating or cooling mode of the thermostat.                                                                                                                                                                                                            |                                                                |                          |                  |       |

| Obj                                                                                                                                                                                                                                                                                | Object name                     | Function                               | Type/<br>length  | Flags |
|------------------------------------------------------------------------------------------------------------------------------------------------------------------------------------------------------------------------------------------------------------------------------------|---------------------------------|----------------------------------------|------------------|-------|
| 48                                                                                                                                                                                                                                                                                 | <b>Application mode</b>         | HVAC control mode                      | 20.105<br>1 byte | CWU   |
| 0                                                                                                                                                                                                                                                                                  | Auto (default)                  | Heating and/or cooling                 |                  |       |
| 1                                                                                                                                                                                                                                                                                  | Heat                            | Heating only                           |                  |       |
| 2                                                                                                                                                                                                                                                                                  | Morning warmup*                 | Heating only                           |                  |       |
| 3                                                                                                                                                                                                                                                                                  | Cool                            | Cooling only                           |                  |       |
| 5                                                                                                                                                                                                                                                                                  | Precool*                        | Cooling only                           |                  |       |
| 6                                                                                                                                                                                                                                                                                  | OFF                             | Neither heating nor cooling            |                  |       |
| 8                                                                                                                                                                                                                                                                                  | Emergency heat*                 | Heating only                           |                  |       |
| 9                                                                                                                                                                                                                                                                                  | Fan only                        | Fan runs at high speed                 |                  |       |
| * Function handled like Heat (1) or Cool (3)                                                                                                                                                                                                                                       |                                 |                                        |                  |       |
| 49                                                                                                                                                                                                                                                                                 | <b>Dew point alarm</b>          | No alarm<br>Alarm                      | 1.005<br>1 bit   | CWU   |
| Indicates the status of dew point operation.                                                                                                                                                                                                                                       |                                 |                                        |                  |       |
| 50                                                                                                                                                                                                                                                                                 | <b>Enable fan command value</b> | Enable<br>Disable                      | 1.003<br>1 bit   | CWU   |
| Set fan mode to Auto (disable) or Manual (enable) by a KNX control unit. If Manual, the value received on <b>Fan command value</b> (52) will be used to command the fan speed.<br>Default: Enable<br>The last interaction wins – either from the local fan mode button or via bus. |                                 |                                        |                  |       |
| 51                                                                                                                                                                                                                                                                                 | <b>Fan operation</b>            | Auto<br>Manual                         | 1.001<br>1 bit   | CRT   |
| Indicates the status of the fan mode: Auto (0) or Manual (1).                                                                                                                                                                                                                      |                                 |                                        |                  |       |
| 52                                                                                                                                                                                                                                                                                 | <b>Fan speed value</b>          | 0...100 %                              | 5.001<br>1 byte  | CWU   |
| The fan can be set to a specified speed by a KNX control unit when manual fan operation is enabled.                                                                                                                                                                                |                                 |                                        |                  |       |
|                                                                                                                                                                                                                                                                                    | Speed                           | Fan command value (physical KNX value) |                  |       |
|                                                                                                                                                                                                                                                                                    | 1                               | 1...33 % (1...85)                      |                  |       |
|                                                                                                                                                                                                                                                                                    | 2                               | 34...67 % (86...170)                   |                  |       |
|                                                                                                                                                                                                                                                                                    | 3                               | 68...100 % (171...255)                 |                  |       |
| Fan speed "0" is not supported by the thermostat and the fan speed will remain unchanged.                                                                                                                                                                                          |                                 |                                        |                  |       |

| Obj                                                                                                                                                                                             | Object name                                     | Function                           | Type/length      | Flags       |
|-------------------------------------------------------------------------------------------------------------------------------------------------------------------------------------------------|-------------------------------------------------|------------------------------------|------------------|-------------|
| 53                                                                                                                                                                                              | <b>Fan output</b>                               | 0...100 %                          | 5.001<br>1 byte  | CRT         |
| Indicates the current fan speed as a value 0...100 %.                                                                                                                                           |                                                 |                                    |                  |             |
|                                                                                                                                                                                                 | Speed                                           | DC fan output (physical KNX value) |                  | 3-speed fan |
|                                                                                                                                                                                                 | OFF                                             | 0 % (0)                            |                  |             |
|                                                                                                                                                                                                 | 1                                               | P357                               |                  | 33          |
|                                                                                                                                                                                                 | 2                                               | P357+1...P358                      |                  | 66          |
|                                                                                                                                                                                                 | 3                                               | P358+1...P359/P360                 |                  | 100         |
| Note: For DC fan manual speed value, speed 1 is P357, speed 2 is P358, speed 3 is P359/P360.                                                                                                    |                                                 |                                    |                  |             |
| 54                                                                                                                                                                                              | <b>Fan speed 1 (receive)</b>                    | Off                                | 1.001<br>1 bit   | CWU         |
| 55                                                                                                                                                                                              | <b>Fan speed 2 (receive)</b>                    | On                                 |                  |             |
| 56                                                                                                                                                                                              | <b>Fan speed 3 (receive)</b>                    |                                    |                  |             |
| The fan can be set to a specified speed by a KNX control unit when manual fan operation is enabled.                                                                                             |                                                 |                                    |                  |             |
| 57                                                                                                                                                                                              | <b>Fan speed 1 (send)</b>                       | Off                                | 1.001<br>1 bit   | CRT         |
| 58                                                                                                                                                                                              | <b>Fan speed 2 (send)</b>                       | On                                 |                  |             |
| 59                                                                                                                                                                                              | <b>Fan speed 3 (send)</b>                       |                                    |                  |             |
| Indicate the state of the relay outputs.                                                                                                                                                        |                                                 |                                    |                  |             |
| 60                                                                                                                                                                                              | <b>Outside temperature</b>                      | Temperature                        | 9.001<br>2 bytes | CWU         |
| The outside temperature measured by a KNX sensor can be displayed on the thermostat, if P009 "Additional display information" is set to 2 (outside temperature).<br>The range is -50...+100 °C. |                                                 |                                    |                  |             |
| 61                                                                                                                                                                                              | <b>Heating, control value continuous</b>        | 0...100 %                          | 5.001<br>1 byte  | CRT         |
| Indicates the physical position of the heating actuator of the first stage.<br>The signal controls (via KNX) the heating valve (e.g. for a 4-pipe system).                                      |                                                 |                                    |                  |             |
| 62                                                                                                                                                                                              | <b>Heating, control value continuous, seq 2</b> | 0...100 %                          | 5.001<br>1 byte  | CRT         |
| Indicates the physical position of the heating actuator of the second stage.<br>The signal controls (via KNX) the heating valve for stage 2 (e.g. for a 4-pipe / 2-stage system).               |                                                 |                                    |                  |             |
| 63                                                                                                                                                                                              | <b>Cooling, control value continuous</b>        | 0...100 %                          | 5.001<br>1 byte  | CRT         |
| Indicates the physical position of the cooling actuator of the first stage. The signal controls (via KNX) the cooling valve (e.g. for a 4-pipe system).                                         |                                                 |                                    |                  |             |
| 64                                                                                                                                                                                              | <b>Cooling, control value continuous, seq 2</b> | 0...100 %                          | 5.001<br>1 byte  | CRT         |
| Indicates the physical position of the cooling actuator of the second stage. The signal controls (via KNX) the cooling valve for stage 2 (e.g. for a 4-pipe / 2-stage system).                  |                                                 |                                    |                  |             |

| Obj                                                                                                                                                                                            | Object name                                               | Function           | Type/length     | Flags |
|------------------------------------------------------------------------------------------------------------------------------------------------------------------------------------------------|-----------------------------------------------------------|--------------------|-----------------|-------|
| 65                                                                                                                                                                                             | <b>Heating, control value status</b>                      | Inactive<br>Active | 1.011<br>1 bit  | CRT   |
| Indicates the control status of heating actuator of the first stage                                                                                                                            |                                                           |                    |                 |       |
| 66                                                                                                                                                                                             | <b>Heating, control value status seq 2</b>                | Inactive<br>Active | 1.011<br>1 bit  | CRT   |
| Indicates the control status of heating actuator of the second stage.                                                                                                                          |                                                           |                    |                 |       |
| 67                                                                                                                                                                                             | <b>Cooling, control value status</b>                      | Inactive<br>Active | 1.011<br>1 bit  | CRT   |
| Indicates the control status of cooling actuator of the first stage.                                                                                                                           |                                                           |                    |                 |       |
| 68                                                                                                                                                                                             | <b>Cooling, control value status seq 2</b>                | Inactive<br>Active | 1.011<br>1 bit  | CRT   |
| Indicates the control status of cooling actuator of the second stage.                                                                                                                          |                                                           |                    |                 |       |
| 69                                                                                                                                                                                             | <b>Heating or cooling, control value status</b>           | Inactive<br>Active | 1.011<br>1 bit  | CRT   |
| Indicates the control status of heating/cooling actuator of the first stage.                                                                                                                   |                                                           |                    |                 |       |
| 70                                                                                                                                                                                             | <b>Heating or cooling, control value status seq2</b>      | Inactive<br>Active | 1.011<br>1 bit  | CRT   |
| Indicates the control status of heating/cooling actuator of the second stage.                                                                                                                  |                                                           |                    |                 |       |
| 71                                                                                                                                                                                             | <b>Heating or cooling, control value continuous</b>       | 0...100 %          | 5.001<br>1 byte | CRT   |
| Indicates the physical position of the heating/cooling actuator of the first stage. The signal controls (via KNX) the heating/cooling valve (e.g. for a 2-pipe system).                        |                                                           |                    |                 |       |
| 72                                                                                                                                                                                             | <b>Heating or cooling, control value continuous seq 2</b> | 0...100 %          | 5.001<br>1 byte | CRT   |
| Indicates the physical position of the heating/cooling actuator of the second stage. The signal controls (via KNX) the heating/cooling valve for stage 2 (e.g. for a 2-pipe / 2-stage system). |                                                           |                    |                 |       |
| 73                                                                                                                                                                                             | <b>Control dehumidification</b>                           | Inactive<br>Active | 1.011<br>1 bit  | CRT   |
| Indicates the control status of the dehumidification.                                                                                                                                          |                                                           |                    |                 |       |
| 74                                                                                                                                                                                             | <b>Control humidification</b>                             | Inactive<br>Active | 1.011<br>1 bit  | CRT   |
| Indicates the control status of the humidification.                                                                                                                                            |                                                           |                    |                 |       |

| Obj                                                                                                                                                                                                                                                                                                                                                                                                                                                       | Object name                                            | Function                                       | Type/<br>length  | Flags |
|-----------------------------------------------------------------------------------------------------------------------------------------------------------------------------------------------------------------------------------------------------------------------------------------------------------------------------------------------------------------------------------------------------------------------------------------------------------|--------------------------------------------------------|------------------------------------------------|------------------|-------|
| 75                                                                                                                                                                                                                                                                                                                                                                                                                                                        | <b>Hum. Control mode</b>                               | Inactive<br>Humidification<br>Dehumidification | 20.115<br>1 byte | CRT   |
| Indicates the mode of the humidity control function:<br>0 = inactive<br>1 = humidification; relative humidity lower than setpoint low P026<br>2 = dehumidification; relative humidity higher than setpoint high P024<br>3...255 = not used                                                                                                                                                                                                                |                                                        |                                                |                  |       |
| 76                                                                                                                                                                                                                                                                                                                                                                                                                                                        | <b>Enable electric heater</b>                          | Enable/disable                                 | 1.003<br>1bit    | CWU   |
| An electric heater can be disabled with this communication object (e.g., to meet tariff regulations).<br>The same function is also available via local multifunctional input X1/X2/U1 (P150, P153, P155).<br>Only one input source must be used, either local input X1/X2/U1 or KNX bus.                                                                                                                                                                  |                                                        |                                                |                  |       |
| 77                                                                                                                                                                                                                                                                                                                                                                                                                                                        | <b>Built-in room relative humidity value [%r.h.]</b>   | I/O                                            | 9.007<br>2 bytes | CRT   |
| The value of the room humidity measured via built-in sensor is available on bus.                                                                                                                                                                                                                                                                                                                                                                          |                                                        |                                                |                  |       |
| 78                                                                                                                                                                                                                                                                                                                                                                                                                                                        | <b>External room relative humidity value [%r.h.]</b>   | I/O                                            | 9.007<br>2 bytes | CWU   |
| The thermostat receives and works with the relative humidity value from an external sensor.                                                                                                                                                                                                                                                                                                                                                               |                                                        |                                                |                  |       |
| 79                                                                                                                                                                                                                                                                                                                                                                                                                                                        | <b>Room rel. humidity: Setpoint high</b>               | I                                              | 9.007<br>2 bytes | CWU   |
| Communication object adjusts the humidity setpoint high used by the thermostat. It changes the value of P024.<br>S-Mode object must be enabled by setting " <b>Humidity setpoints</b> " to " <b>as group object</b> " in ETS.<br>The range is (0), P026 (min. 20 %)...90 %.<br>The humidity maximum setpoint is stored in EEPROM. The service life of the EEPROM depends on the number of write cycles. Never write this communication object cyclically. |                                                        |                                                |                  |       |
| 80                                                                                                                                                                                                                                                                                                                                                                                                                                                        | <b>Room rel. humidity: Setpoint low</b>                | I                                              | 9.007<br>2 bytes | CWU   |
| Communication object adjusts the humidity setpoint low used by the thermostat. It changes the value of P026.<br>S-Mode object must be enabled by setting " <b>Humidity setpoints</b> " to " <b>as group object</b> " in ETS.<br>The range is (0), 20 %...P024 (max. 90 %).<br>The humidity minimum setpoint is stored in EEPROM. The service life of the EEPROM depends on the number of write cycles. Never write this communication object cyclically.  |                                                        |                                                |                  |       |
| 81                                                                                                                                                                                                                                                                                                                                                                                                                                                        | <b>Reset the Energy efficiency status (Green leaf)</b> | No action<br>Reset                             | 1.017<br>1 bit   | CWU   |
| Resets the settings to green leaf.                                                                                                                                                                                                                                                                                                                                                                                                                        |                                                        |                                                |                  |       |
| 82                                                                                                                                                                                                                                                                                                                                                                                                                                                        | <b>Energy efficiency status / Green Leaf</b>           | Green<br>Red                                   | 1.006<br>1 bit   | CRT   |
| Indicates current status of green leaf.                                                                                                                                                                                                                                                                                                                                                                                                                   |                                                        |                                                |                  |       |

| Obj                                                                                                                                                                                                                                                                                         | Object name                                          | Function               | Type/<br>length  | Flags |
|---------------------------------------------------------------------------------------------------------------------------------------------------------------------------------------------------------------------------------------------------------------------------------------------|------------------------------------------------------|------------------------|------------------|-------|
| 83                                                                                                                                                                                                                                                                                          | <b>Enable or disable Leaf indication</b>             | Disable<br>Enable      | 1.003<br>1 bit   | CWU   |
| Enables or disables the leaf (green or red) indication.                                                                                                                                                                                                                                     |                                                      |                        |                  |       |
| 84                                                                                                                                                                                                                                                                                          | <b>Keypad: Lock fan speed</b>                        | Lock<br>Unlock         | 1.002<br>1 bit   | CWU   |
| Locks or unlocks the fan operation keypad in current fan speed.                                                                                                                                                                                                                             |                                                      |                        |                  |       |
| 85                                                                                                                                                                                                                                                                                          | <b>Keypad: Lock fan speed in "auto" mode</b>         | Lock<br>Unlock         | 1.002<br>1 bit   | CWU   |
| Locks or unlocks the fan operation keypad in "auto" speed.                                                                                                                                                                                                                                  |                                                      |                        |                  |       |
| 86                                                                                                                                                                                                                                                                                          | <b>Keypad: Lock the setpoint shift</b>               | Lock<br>Unlock         | 1.002<br>1 bit   | CWU   |
| Locks or unlocks the setpoint shift keypad.                                                                                                                                                                                                                                                 |                                                      |                        |                  |       |
| 87                                                                                                                                                                                                                                                                                          | <b>Keypad: Lock the operating mode</b>               | Lock<br>Unlock         | 1.002<br>1 bit   | CWU   |
| Locks or unlocks the operating mode keypad.                                                                                                                                                                                                                                                 |                                                      |                        |                  |       |
| 88                                                                                                                                                                                                                                                                                          | <b>Room operating mode: Presence detector</b>        | Unoccupied<br>Occupied | 1.018<br>1 bit   | CRT   |
| Status of the presence mode of the device, from KNX bus or from universal inputs X1, X2 or U1.                                                                                                                                                                                              |                                                      |                        |                  |       |
| 89                                                                                                                                                                                                                                                                                          | <b>Room operating mode: Window contact</b>           | Close<br>Open          | 1.019<br>1 bit   | CRT   |
| Window state of the device, from KNX bus or from universal inputs X1, X2 or U1.                                                                                                                                                                                                             |                                                      |                        |                  |       |
| 90                                                                                                                                                                                                                                                                                          | <b>Room temp: Current cooling setpoint (send)</b>    | Temperature            | 9.001<br>2 bytes | CRT   |
| Communication object adjusts the current cooling setpoint used by the thermostat (see Setting and adjusting setpoints [→ 42]).<br>S-Mode object needs to be enabled by setting <b>Room temp: Current setpoint</b> to <b>as group object</b> in ETS.                                         |                                                      |                        |                  |       |
| 91                                                                                                                                                                                                                                                                                          | <b>Room temp: Current heating setpoint (send)</b>    | Temperature            | 9.001<br>2 bytes | CRT   |
| Communication object adjusts the current heating setpoint sent by the thermostat (see Setting and adjusting setpoints [→ 42]).<br>S-Mode object needs to be enabled by setting <b>Room temp: Current setpoint</b> to <b>as group object</b> in ETS.                                         |                                                      |                        |                  |       |
| 92                                                                                                                                                                                                                                                                                          | <b>Room temp: Current heating setpoint (receive)</b> | Temperature            | 9.001<br>2 bytes | CWU   |
| Communication object adjusts the current heating setpoint received by the thermostat from bus (see Setting and adjusting setpoints [→ 42]).<br>The range is 5...40 °C.<br>S-Mode object needs to be enabled by setting <b>Room temp: Current setpoint</b> to <b>as group object</b> in ETS. |                                                      |                        |                  |       |



| Obj                                                                                                                                                                                                                                                                                                 | Object name                                          | Function                         | Type/length      | Flags |
|-----------------------------------------------------------------------------------------------------------------------------------------------------------------------------------------------------------------------------------------------------------------------------------------------------|------------------------------------------------------|----------------------------------|------------------|-------|
| 93                                                                                                                                                                                                                                                                                                  | <b>Room temp: Current cooling setpoint (receive)</b> | Temperature                      | 9.001<br>2 bytes | CWU   |
| <p>Communication object adjusts the current cooling setpoint received by the thermostat from bus (see Setting and adjusting setpoints [→ 42]).</p> <p>The range is 5...40 °C.</p> <p>S-Mode object needs to be enabled by setting <b>Room temp: Current setpoint to as group object</b> in ETS.</p> |                                                      |                                  |                  |       |
| 94                                                                                                                                                                                                                                                                                                  | <b>Room operating mode: Status (receive)</b>         | Comfort<br>Economy<br>Protection | 20.102<br>1 byte | CWU   |
| <p>Actual room operating mode received by the thermostat (Manager) from bus (considering time switch, user selection, window contact, etc.) This state information is available via one 8-bit enumeration.</p>                                                                                      |                                                      |                                  |                  |       |
| 95                                                                                                                                                                                                                                                                                                  | <b>ChangeOverWater status (send)</b>                 | Heating: 1<br>Cooling: 0         | 1.100<br>1 bit   | CRT   |
| <p>Sends the water changeover information.</p>                                                                                                                                                                                                                                                      |                                                      |                                  |                  |       |
| 96                                                                                                                                                                                                                                                                                                  | <b>ChangeOverWater status (receive)</b>              | Heating: 1<br>Cooling: 0         | 1.100<br>1 bit   | CWU   |
| <p>Water changeover information received via bus.</p>                                                                                                                                                                                                                                               |                                                      |                                  |                  |       |
| 97                                                                                                                                                                                                                                                                                                  | <b>Manual fan command value (send)</b>               | 0...100 %                        | 5.001<br>1 byte  | CRT   |
| <p>Sends the manual fan command value.</p>                                                                                                                                                                                                                                                          |                                                      |                                  |                  |       |
| 98                                                                                                                                                                                                                                                                                                  | <b>DC fan speed: Maximum speed heating</b>           | 0...100 %                        | 5.001<br>1 byte  | CWU   |
| <p>DC fan speed for maximum heating output received via bus.</p>                                                                                                                                                                                                                                    |                                                      |                                  |                  |       |
| 99                                                                                                                                                                                                                                                                                                  | <b>DC fan speed: Maximum speed cooling</b>           | 0...100 %                        | 5.001<br>1 byte  | CWU   |
| <p>DC fan speed for maximum cooling output received via bus.</p>                                                                                                                                                                                                                                    |                                                      |                                  |                  |       |
| 100                                                                                                                                                                                                                                                                                                 | <b>Built-in room air quality value</b>               | Air quality                      | 9.008<br>2 bytes | CRT   |
| <p>The room air quality value (CO<sub>2</sub>) is measured via built-in sensor or external sensor over the bus. (Manager)</p>                                                                                                                                                                       |                                                      |                                  |                  |       |

| Obj                                                                                                             | Object name                                      | Function    | Type/length      | Flags |
|-----------------------------------------------------------------------------------------------------------------|--------------------------------------------------|-------------|------------------|-------|
| 101                                                                                                             | <b>External room air quality value</b>           | Air quality | 9.008<br>2 bytes | CWU   |
| <p>The thermostat (Subordinate) receives and works with the room air quality value from an external sensor.</p> |                                                  |             |                  |       |
| 102                                                                                                             | <b>DC damper demand</b>                          | 0...100 %   | 5.001<br>1 byte  | CRT   |
| <p>Indicates the control status of DC damper.</p>                                                               |                                                  |             |                  |       |
| 103                                                                                                             | <b>On/Off damper demand</b>                      | On<br>Off   | 1.001<br>1 bit   | CRT   |
| <p>Indicates the control status of On/Off damper.</p>                                                           |                                                  |             |                  |       |
| 104                                                                                                             | <b>PICV heating maximal position [P260]</b>      | 0...100 %   | 5.001<br>1 byte  | CWU   |
| <p>PICV heating maximal position received via bus.</p>                                                          |                                                  |             |                  |       |
| 105                                                                                                             | <b>PICV cooling maximal position [P261]</b>      | 0...100 %   | 5.001<br>1 byte  | CWU   |
| <p>PICV cooling maximal position received via bus.</p>                                                          |                                                  |             |                  |       |
| 106                                                                                                             | <b>Room rel. humidity setpoint high Eco</b>      | l           | 9.007<br>2 bytes | CWU   |
| <p>Room relative humidity high setpoint in Economy received via bus.</p>                                        |                                                  |             |                  |       |
| 107                                                                                                             | <b>Room air quality: Setpoint [ppm] [P023]</b>   | Air quality | 9.008<br>2 bytes | CWU   |
| <p>Room air quality setpoint received via bus.</p>                                                              |                                                  |             |                  |       |
| 108                                                                                                             | <b>[P455] Minimum damper position [%] [P455]</b> | 0...100 %   | 5.001<br>1 byte  | CWU   |
| <p>Minimum damper position received via bus.</p>                                                                |                                                  |             |                  |       |
| 109                                                                                                             | <b>[P457] Maximum damper position [%] [P457]</b> | 0...100 %   | 5.001<br>1 byte  | CWU   |
| <p>Maximum damper position received via bus.</p>                                                                |                                                  |             |                  |       |

## 4.14 Communication objects (LTE-Mode) (RDG2..KN)

|                                                  |   | RDG |                                     |   |                               |
|--------------------------------------------------|---|-----|-------------------------------------|---|-------------------------------|
|                                                  |   |     | Geographical zone<br>A.R.S          |   |                               |
| Room operating mode:<br>Time switch              |   | →   | (Time switch zone)<br>X.1.1/X.Y.1   |   |                               |
| Application mode                                 |   | →   |                                     |   |                               |
| Room operating mode:<br>Preselection             |   | →   | Geographical zone<br>A.R.S<br>X.Y.1 |   |                               |
|                                                  |   |     |                                     | ↔ | Room temperature              |
|                                                  |   |     |                                     | ↔ | Room air quality              |
|                                                  |   |     |                                     | → | Supply air temperature        |
|                                                  |   |     |                                     | → | Dew point status              |
| Comfort setpoint                                 |   | →   |                                     | ↔ | Room humidity [% r.h.]        |
| Setpoint heating                                 |   | →   |                                     |   |                               |
| Setpoint cooling                                 |   | →   |                                     |   |                               |
| TempRoomSetpSetHeat                              |   | →   |                                     | → | TempRoomSetpHeatEff           |
| TempRoomSetpSetCool                              |   | →   |                                     | → | TempRoomSetpCoolEff           |
| TempRoomSetpUserOffset                           |   | →   |                                     | → | TempRoomSetpUserOffsetEff     |
| Fan speed                                        |   | →   |                                     | → | FanSpeedUserEff               |
|                                                  |   |     |                                     | → | FanSpeedSetpEff               |
| Setpoint shift heating<br>Setpoint shift cooling |   | →   |                                     |   |                               |
| Energy efficiency request                        |   | →   |                                     | → | Energy efficiency indication  |
|                                                  |   |     |                                     | ↔ | Window status                 |
|                                                  |   |     |                                     | ↔ | Presence status               |
|                                                  |   |     |                                     |   |                               |
|                                                  |   |     | Heat distr. zone                    | → | Heating coil energy demand    |
| FlowTemperatureHeat                              | } | →   | heating coil                        |   |                               |
| Heating/cooling changeover                       |   |     | Ref. distr. zone                    |   |                               |
| FlowTemperatureCool                              |   | →   | Cooling coil                        | → | Cooling coil energy demand    |
|                                                  |   |     | Heating distr. zone                 |   |                               |
|                                                  |   |     | Heating surface                     | → | Energy demand heating surface |
|                                                  |   |     | Broadcast                           |   |                               |
| Fault transmission                               |   | →   |                                     | → | Fault information             |
|                                                  |   |     |                                     | → | Fault text                    |
|                                                  |   |     | Outside air temp. zone              |   |                               |
| Outside temperature                              |   | →   | Fixed at 31                         |   |                               |
|                                                  |   |     |                                     |   |                               |
|                                                  |   |     |                                     |   |                               |

## 4.15 Control parameters

To optimize control performance, a number of control parameters can be readjusted on the thermostat via HMI, commissioning/operating tool, or Siemens smartphone application PCT Go. These parameters can also be set during operation without opening the unit.

### Power failure

In the event of a power failure, all settings for control parameter, setpoint, operating mode and changeover value are retained.

The control parameters are assigned to 2 levels:

- Service level, and
- Expert level, including communications, diagnostics and test

The Service level contains a small set of parameters to set up the thermostat for the HVAC system and to adjust the user interface. These parameters can be adjusted any time.

The parameters at the Expert level need careful configuration because they impact the thermostat's control performance and functionality.

### 4.15.1 Parameter setting via local HMI

#### Enter only Service level

1. Press both left and right buttons simultaneously for 3 seconds or until the device beeps if the buzzer is enabled (P030). Release and within 0.5...4 seconds, press the right button again until **P001** is displayed. Continue with step 2.

#### Enter Expert level with Diagnostics and test

1. Press both left and right buttons simultaneously for 3 seconds or until the device beeps if the buzzer is enabled (P030). Release and within 0.5...4 seconds, press the left button again until the temperature display disappears. Turn the rotary knob counterclockwise minimum ½ rotation. **P050** displays. Continue with step 2.

#### Adjust parameters

2. Select the required parameter by turning the rotary knob.
3. Press ✓ (OK); the current value of the selected parameter begins to flash and can be changed by turning the rotary knob.
4. Press ✓ (OK) to confirm the adjusted value or press ↵ (Esc) to cancel the change.
5. If you want to adjust additional parameters, repeat steps 2...4.
6. Press ↵ (Esc) to exit parameter setting mode.

#### Reset parameters

The factory setting for the control parameters can be reloaded via P505, by changing the value to On. Confirm the change by pressing the right button. **8888** is then displayed during reloading and device restarts 4 s later.

#### Note:

If password protection (needs to be done by HVAC installer) is enabled, users must enter the password to open parameter setting mode. If the password is mistyped 5 times, the thermostat is locked and the password cannot be entered for 5 minutes. Symbols ⏻ and 🔒 are displayed.

### 4.15.2 Setting/downloading parameter via tool (RDG2..KN)

The control parameters can be adjusted via bus either by parameter download during commissioning or during normal operation with a tool like ACS.

With the ACS tool, the parameters can be changed...

- During commissioning via parameter download (all parameters)
- During operation via Popcard (most parameters)



ACS

#### OZW772 Web server

Most parameters can be changed during operations using the OZW772 web server.



ETS

ETS is an engineering tool used to fully commission RDG2..KN KNX room thermostats. Device address, application, and control parameters can be defined and downloaded via ETS.

**Note:** If users abort operation during commissioning, full commissioning cannot be restarted until the device reboots. Before rebooting, only the application can be downloaded.

#### Connecting a KNX tool

Connecting a KNX commissioning/operating tool to the RDG2..KN is described in Commissioning.

### 4.15.3 Service level parameters

Parameter display depends on selected application and function. Appl means application. Parameter values are only visible when the device is set as Manager (M), Subordinate (S) or both identification (✓).

| Parameter            | Name                                                                                                            | Factory setting                                                       | Range                                                                                                                                                                                                                                                                                                                              | RDG20.. | RDG26.. | Dependencies     |
|----------------------|-----------------------------------------------------------------------------------------------------------------|-----------------------------------------------------------------------|------------------------------------------------------------------------------------------------------------------------------------------------------------------------------------------------------------------------------------------------------------------------------------------------------------------------------------|---------|---------|------------------|
|                      | Service level                                                                                                   |                                                                       |                                                                                                                                                                                                                                                                                                                                    |         |         |                  |
| P001                 | Control sequence <sup>1)</sup>                                                                                  | 2-pipe:<br>1 = Cooling only<br><br>4-pipe:<br>4 = Heating and cooling | 0 = Heating only<br>1 = Cooling only<br>2 = H/C changeover auto<br>3 = H/C changeover manual<br>4 = Heating and cooling                                                                                                                                                                                                            | ✓       | ✓       | P002             |
| P002 <sup>4)</sup>   | Operation via room operating mode selector <sup>1)</sup>                                                        | 1                                                                     | 1 = Auto – Protection / Auto - Comfort – Protection (when there is local scheduler)<br>2 = Auto - Comfort - Economy - Protection<br>3 = Auto (Comfort) - Protection Hospitality<br>4 = Auto – Protection (RDG2..T)                                                                                                                 | M       | M       | P001, P005, P258 |
| P003 <sup>4)</sup>   | Operation via fan operating selector <sup>2)</sup>                                                              | 0                                                                     | 0 = Auto - Manual<br>1 = Manual<br>2 = Auto - Manual - Protection<br>3 = Auto – Protection<br>4 = Forced ventilation (RDG2x4KN)<br>5 = Forced ventilation, fan auto-manual (RDG2x4KN)                                                                                                                                              | M       | M       | P350, P258       |
| P004                 | Unit                                                                                                            | 0                                                                     | 0 = °C (parameter in °C)<br>1 = °F (parameter in °F)                                                                                                                                                                                                                                                                               | ✓       | ✓       | –                |
| P005 <sup>4)6)</sup> | Scheduler                                                                                                       | RDG2..KN:<br>OFF<br>RDG2..T: ON                                       | ON = Enabled<br>OFF = Disabled                                                                                                                                                                                                                                                                                                     | M       | M       | P002, P258       |
| P006                 | Measured value correction                                                                                       | 0 K                                                                   | -5...5 K                                                                                                                                                                                                                                                                                                                           | ✓       | ✓       | –                |
| P007                 | Humidity value correction (RDG2..KN)                                                                            | 0                                                                     | -10...0...10 %                                                                                                                                                                                                                                                                                                                     | ✓       | ✓       | –                |
| P008                 | Standard display                                                                                                | 0                                                                     | 0 = Room temperature<br>1 = Setpoint                                                                                                                                                                                                                                                                                               | ✓       | ✓       | –                |
| P009                 | Additional display information<br>RDG200KN, RDG260KN: 0...5<br>RDG204KN, RDG264KN: 0...9<br>RDG2..T: 0, 1, 3, 4 | 0                                                                     | 0 = --- (No display)<br>1 = °C and °F<br>2 = Outside temperature<br>3 = Time of day (12 h)<br>4 = Time of day (24 h)<br>5 = Humidity<br>6 = Indoor air quality (numeric) <sup>5)</sup><br>7 = Indoor air quality (text) <sup>5)</sup><br>8 = Humidity and IAQ (numeric) <sup>5)</sup><br>9 = Humidity and IAQ (text) <sup>5)</sup> | ✓       | ✓       | –                |
| P010                 | Setpoint concept                                                                                                | 1                                                                     | 1 = Comfort concept<br>2 = Energy saving concept                                                                                                                                                                                                                                                                                   | ✓       | ✓       | P104             |
| P011 <sup>4)</sup>   | Comfort basic setpoint                                                                                          | 21 °C (70 °F)                                                         | 5...40 °C (41...104 °F)                                                                                                                                                                                                                                                                                                            | M       | M       | P258             |
| P013                 | Comfort setpoint minimum                                                                                        | 5 °C (41 °F)                                                          | (P010 = 1): 5 °C (41 °F)...P016-1 K<br>(P010 = 2): 5 °C (41 °F)...P014-1 K                                                                                                                                                                                                                                                         | ✓       | ✓       | P010             |
| P014                 | Comfort setpoint maximum heating                                                                                | 21 °C (70 °F)                                                         | P013+1 K...P015-1 K                                                                                                                                                                                                                                                                                                                | ✓       | ✓       | P010             |
| P015                 | Comfort setpoint minimum cooling                                                                                | 25 °C (77 °F)                                                         | P014+1 K...P016 -1 K                                                                                                                                                                                                                                                                                                               | ✓       | ✓       | P010             |
| P016                 | Comfort setpoint maximum                                                                                        | 35 °C (95 °F)                                                         | (P010 = 1): P013 +1 K...40 °C (104 °F)<br>(P010 = 2): P015 +1 K...40 °C (104 °F)                                                                                                                                                                                                                                                   | ✓       | ✓       | P010             |
| P017 <sup>4)</sup>   | Summer time                                                                                                     | 1                                                                     | OFF<br>1 = Europe<br>2 = Australia<br>3 = New Zealand                                                                                                                                                                                                                                                                              | M       | M       | P258             |
| P019 <sup>4)</sup>   | Economy heating setpoint                                                                                        | 15 °C (59 °F)                                                         | --- (0), 5 °C...P020 (41 °F...P020)<br>P020 = 40 °C max. (P020 = 104 °F max.)                                                                                                                                                                                                                                                      | M       | M       | P258             |
| P020 <sup>4)</sup>   | Economy cooling setpoint                                                                                        | 30 °C (86 °F)                                                         | --- (0), P019...40 °C (P019...104 °F)<br>P019 = 5 °C min. (P019 = 41 °F min.)                                                                                                                                                                                                                                                      | M       | M       | P258             |

| Parameter                           | Name                                      | Factory setting | Range                                                                                                                                                                                                                                                                                                                                                                                                                                                                                                                                                                                                                         | RDG20.. | RDG26.. | Dependencies  |
|-------------------------------------|-------------------------------------------|-----------------|-------------------------------------------------------------------------------------------------------------------------------------------------------------------------------------------------------------------------------------------------------------------------------------------------------------------------------------------------------------------------------------------------------------------------------------------------------------------------------------------------------------------------------------------------------------------------------------------------------------------------------|---------|---------|---------------|
|                                     | Service level                             |                 |                                                                                                                                                                                                                                                                                                                                                                                                                                                                                                                                                                                                                               |         |         |               |
| P023 <sup>5)</sup><br><sup>7)</sup> | Indoor air quality setpoint (RDG2..KN)    | 1000 ppm        | 10...2000 ppm                                                                                                                                                                                                                                                                                                                                                                                                                                                                                                                                                                                                                 | ✓       | ✓       | P450          |
| P024 <sup>4)</sup>                  | Humidity setpoint high (RDG2..KN)         | 50              | --- (0), P026 or 20...90 %                                                                                                                                                                                                                                                                                                                                                                                                                                                                                                                                                                                                    | M       | M       | P450,<br>P258 |
| P025                                | Humidity setpoint high ECO (RDG2..KN)     | OFF             | --- (0), P026...90 %, or 20...90 %                                                                                                                                                                                                                                                                                                                                                                                                                                                                                                                                                                                            | M       | M       | P258          |
| P026 <sup>4)</sup>                  | Humidity setpoint low (RDG2..KN)          | OFF             | --- (0), 20...90 % or P024                                                                                                                                                                                                                                                                                                                                                                                                                                                                                                                                                                                                    | M       | M       | P450,<br>P258 |
| P027 <sup>3)</sup>                  | Electric heater when cooling              | ON              | ON: Enabled<br>OFF: Disabled                                                                                                                                                                                                                                                                                                                                                                                                                                                                                                                                                                                                  | ✓       | ✓       | Appl          |
| P028 <sup>4)</sup>                  | Keypad                                    | 0               | 0 = Unlocked<br>1 = Auto lock<br>2 = Manual lock<br>3 = Auto lock the operating mode<br>4 = Auto lock the Setpoint shift<br>5 = Auto lock fan speed<br>6 = Auto lock operating mode, setpoint shift<br>7 = Auto lock operating mode, fan speed<br>8 = Auto lock fan speed, setpoint shift<br>9 = Auto lock scheduler<br>10 = Auto lock operating mode, scheduler<br>11 = Auto lock scheduler, fan speed<br>12 = Auto lock operating mode, scheduler, fan speed<br>13 = Auto lock scheduler, setpoint shift<br>14 = Auto lock operating mode, scheduler, setpoint shift<br>15 = Auto lock scheduler, fan speed, setpoint shift | M       | M       | P258          |
| P029                                | Fan: Dead zone Comfort mode <sup>2)</sup> | 0               | 0 = Fan disable<br>1 = Low speed (Heating and Cooling)<br>2 = Low speed (Cooling only)<br>3 = Fan disable Auto & Manual<br>4 = Low speed Auto & Manual<br>5 = Low speed Auto & Manual Cooling                                                                                                                                                                                                                                                                                                                                                                                                                                 | ✓       | ✓       | P350          |
| P030                                | Buzzer function                           | ON              | ON = Enabled<br>OFF = Disabled                                                                                                                                                                                                                                                                                                                                                                                                                                                                                                                                                                                                | ✓       | ✓       | -             |
| P031                                | Language                                  | 1               | 1 = English<br>2 = Francais (French)<br>3 = Deutsch (German)<br>4 = Italiano (Italian)<br>5 = Espanol (Spanish)<br>6 = Nederlands (Dutch)<br>7 = Turckce (Turkish)<br>8 = Cesky (Czech)<br>9 = Suomi (Finnish)<br>10 = Polski (Polish)<br>11 = Magyar (Hungarian)<br>12 = Slovenski (Slovak)<br>13 = (Limba) Romana (Romanian)<br>14 = Dansk (Danish)<br>15 = Norsk (Norwegian)                                                                                                                                                                                                                                               | ✓       | ✓       | -             |
| P032 <sup>4)</sup>                  | Room operating mode holidays              | 0               | 0 = Economy<br>1 = Protection                                                                                                                                                                                                                                                                                                                                                                                                                                                                                                                                                                                                 | M       | M       | P005,<br>P258 |

**Note:**

- 1) P001 cannot be set to 3 if P002 is set to 3, and vice versa.
- 2) For RDG200KN and RDG260KN: If P350 = 0, P003 is disabled. P029 is invisible. For RDG204KN and RDG264KN: If P350 = 0, P003 is set to 4.
- 3) Only available when application is 2-pipe with electric heater
- 4) If P258 = 0 (Subordinate), the parameter values are not available.
- 5) The parameters are valid for RDG204KN and RDG264KN.
- 6) Time of day cannot be set via ETS, see Scheduler [→ 69].
- 7) If P450 = 2...6 with IAQ control, P023 is visible.

### 4.15.4 Expert level parameters with diagnostics and test

Parameter display depends on selected application and function. Parameter values are only visible when the device is set as Manager (M), Subordinate (S) or both identification (✓).

| Parameter                             | Name                                       | Factory setting | Range                                                                                                                                                        | RDG20.. | RDG26.. | Dependencies                             |
|---------------------------------------|--------------------------------------------|-----------------|--------------------------------------------------------------------------------------------------------------------------------------------------------------|---------|---------|------------------------------------------|
|                                       | Expert level                               |                 |                                                                                                                                                              |         |         |                                          |
| <b>Control settings</b>               |                                            |                 |                                                                                                                                                              |         |         |                                          |
| P050                                  | Heat P-band Xp                             | 2 K             | 0.5...6 K                                                                                                                                                    | ✓       | ✓       | P001                                     |
| P051                                  | Switching differential heating             | 1 K             | 0.5...6 K                                                                                                                                                    | ✓       | ✓       | P001                                     |
| P052                                  | Cool P-band Xp                             |                 |                                                                                                                                                              |         |         |                                          |
| P053                                  | Switching differential cooling             |                 |                                                                                                                                                              |         |         |                                          |
| P054                                  | Radiator P-band Xp/switching differential  | 2 K             | 0.5...6 K                                                                                                                                                    | ✓       | ✓       | –                                        |
| P055 <sup>10)</sup>                   | Dead zone Comfort mode                     | 2 K             | 0.5...5 K                                                                                                                                                    | M       | M       | P258                                     |
| P056                                  | Setpoint differential                      | 2 K             | 0.5...5 K                                                                                                                                                    | ✓       | ✓       | –                                        |
| P057 <sup>1)</sup>                    | Integral action time Tn for heating        | 45 min          | 0...120 min                                                                                                                                                  | ✓       | ✓       | P201,<br>P203,<br>P204                   |
| P058 <sup>1)</sup>                    | Integral action time Tn for cooling        |                 |                                                                                                                                                              |         |         |                                          |
| P059 <sup>2)</sup><br><sup>10)</sup>  | H/C changeover switching point cooling     | 16 °C (61 °F)   | 5 °C...P060-2 K (41 °F...P060-2 K)                                                                                                                           | M       | M       | P001,<br>P150,<br>P153,<br>P155,<br>P258 |
| P060 <sup>2)</sup><br><sup>10)</sup>  | H/C changeover switching point heating     | 28 °C (82 °F)   | P059+2 K...40 °C (P059+2 K...104 °F)                                                                                                                         | M       | M       | P001,<br>P150,<br>P153,<br>P155,<br>P258 |
| P061 <sup>11)</sup>                   | Setpoint ΔT cooling                        | ---             | --- (0), 1...40 K                                                                                                                                            | ✓       | ✓       | P150,<br>P153,<br>P155                   |
| P062 <sup>11)</sup>                   | Setpoint ΔT heating                        | ---             | --- (0), 1...40 K                                                                                                                                            | ✓       | ✓       | P150,<br>P153,<br>P155                   |
| P063                                  | Minimum supply air temperature             | ---             | ---, 0 °C...P064 (32 °F...P064)                                                                                                                              | ✓       | ✓       | P150,<br>P153,<br>P155                   |
| P064                                  | Maximum supply air temperature             | ---             | ---, P063...50 °C (P063...122 °F)                                                                                                                            | ✓       | ✓       | P150,<br>P153,<br>P155                   |
| <b>Mode and setpoints</b>             |                                            |                 |                                                                                                                                                              |         |         |                                          |
| P100 <sup>10)</sup>                   | Protection heating setpoint                | 8 °C (46 °F)    | --- (0), 5 °C...P101; (41 °F...P101)                                                                                                                         | M       | M       | P258                                     |
| P101 <sup>10)</sup>                   | Protection cooling setpoint                | ---             | --- (0), P100...40 °C; (P100...104 °F)                                                                                                                       | M       | M       | P258                                     |
| P102 <sup>3)</sup><br><sup>10)</sup>  | Temporary Comfort mode                     | ---             | --- (0), 1...360 min                                                                                                                                         | M       | M       | P002,<br>P005,<br>P258                   |
| P103 <sup>10)</sup>                   | Temporary Comfort setpoint                 | OFF             | 0 = Disabled (OFF)<br>1 = Enabled (ON)<br>2 = Enabled (ON), excluded Window contact<br>3 = Enabled (ON), excluded presence detector (include hotel presence) | M       | M       | P258                                     |
| P104 <sup>10)</sup>                   | Setpoint display (RDG2..KN)                | 1               | 1 = Absolute setpoints<br>2 = Relative setpoints                                                                                                             | M       | M       | P010<br>P258                             |
| P109 <sup>13)</sup><br><sup>19)</sup> | Outside damper frost protection (RDG2..KN) | ---             | ---; 2...14 °C (35.6...50 °F)                                                                                                                                | ✓       | ✓       | P450                                     |
| P110 <sup>10)</sup>                   | Energy indicator (RDG2..KN)                | 1               | OFF = Disabled<br>1 = Green and Red dimmed out<br>2 = Green dimmed out / Red fixed<br>3 = Green and Red fixed                                                | M       | M       | P258                                     |
| P111 <sup>10)</sup>                   | Energy indicator range (RDG2..KN)          | 2 K             | 0...10 K                                                                                                                                                     | M       | M       | P258                                     |

| Parameter           | Name                                                                                                                                 | Factory setting                                                                                      | Range                                                                                                                                                                                                                                                                                                                                                                                                                                                                                                                                                                                                       | RDG20.. | RDG26.. | Dependencies                                             |     |
|---------------------|--------------------------------------------------------------------------------------------------------------------------------------|------------------------------------------------------------------------------------------------------|-------------------------------------------------------------------------------------------------------------------------------------------------------------------------------------------------------------------------------------------------------------------------------------------------------------------------------------------------------------------------------------------------------------------------------------------------------------------------------------------------------------------------------------------------------------------------------------------------------------|---------|---------|----------------------------------------------------------|-----|
|                     | Expert level                                                                                                                         |                                                                                                      |                                                                                                                                                                                                                                                                                                                                                                                                                                                                                                                                                                                                             |         |         |                                                          |     |
| <b>Inputs</b>       |                                                                                                                                      |                                                                                                      |                                                                                                                                                                                                                                                                                                                                                                                                                                                                                                                                                                                                             |         |         |                                                          |     |
| P150                | Input X1<br>RDG2..KN: 0...14<br>RDG2..T: 0...6 & 9...14                                                                              | P150:1<br>P153:<br>RDG2..KN: 0                                                                       | <u>Synco ACS / PCT Go, ETS terminology</u><br>0 = --- (no function)<br>1 = Room / return temperature                                                                                                                                                                                                                                                                                                                                                                                                                                                                                                        | ✓       | ✓       | P153:<br>P150,<br>P155<br>P155:<br>P150,<br>P153<br>P258 |     |
| P153                | Input X2<br>RDG2..KN: 0...14<br>RDG2..T: 0...6 & 9...14                                                                              | RDG2..T: 2<br>P155:<br>RDG200KN,<br>RDG260KN,<br>RDG200T,<br>RDG260T: 3<br>RDG204KN &<br>RDG264KN: 0 | 2 = H/C changeover <sup>10)</sup><br>3 = Window contact (DI)<br>4 = Dewpoint (DI)<br>5 = Enable electric heater (DI)<br>6 = Fault input (DI)<br>7 = Monitor input (DI)<br>8 = Monitor input temp. (AI)<br>9 = Supply air temperature (AI)<br>10 = Presence detector (DI) <sup>10)</sup><br>11 = External temperature limit (AI)<br>12 = Coil flow temperature (AI)<br>13 = Hotel presence detector / card reader (DI) <sup>10)</sup><br>14 = Coil return temperature (AI)                                                                                                                                   | M       | M       |                                                          |     |
| P155 <sup>20)</sup> | Input U1 (RDG200KN&RDG260KN)<br>Input and output U1<br>(RDG204KN&RDG264KN)<br>RDG2..KN: 0...14<br>Input X3 (RDG2..T): 0...6 & 9...14 |                                                                                                      | <u>Desigo ABT Site terminology</u><br>0 = --- (no function)<br>1 = Room temperature control, external or<br>return air temperature sensor<br>2 = Heating/cooling changeover <sup>10)</sup><br>3 = Window contact<br>4 = Dewpoint sensor<br>5 = Electric heater, enabled<br>6 = Fault input<br>7 = Switching state input<br>8 = Temperature sensor input<br>9 = Supply air temperature<br>10 = Presence detector <sup>10)</sup><br>11 = External temperature sensor, limitation<br>12 = Coil flow temperature<br>13 = Presence detector or card reader, hotel <sup>10)</sup><br>14 = Coil return temperature | ✓       | ✓       |                                                          |     |
| P151                | X1: Normal position and sensor                                                                                                       | 0 when DI or                                                                                         | 0 = Normally Open                                                                                                                                                                                                                                                                                                                                                                                                                                                                                                                                                                                           | ✓       | ✓       |                                                          |     |
| P154                | X2: Normal position and sensor                                                                                                       | AI/DI                                                                                                | 1 = Normally Close                                                                                                                                                                                                                                                                                                                                                                                                                                                                                                                                                                                          |         |         |                                                          |     |
| P156                | U1 (RDG2..KN): Normal position and<br>sensor<br>X3 (RDG2..T): Normal position and<br>sensor                                          | 2 when AI                                                                                            | 2 = NTC-3K<br>3 = LG-Ni1000                                                                                                                                                                                                                                                                                                                                                                                                                                                                                                                                                                                 |         |         |                                                          |     |
| <b>Outputs</b>      |                                                                                                                                      |                                                                                                      |                                                                                                                                                                                                                                                                                                                                                                                                                                                                                                                                                                                                             |         |         |                                                          |     |
| P200                | Number of heating / cooling sequences<br>Note: for 2-/4-pipe 2-stage application                                                     | 1                                                                                                    | 1 = Heating 2 sequences, cooling 2 sequences<br>2 = Heating 2 sequences, cooling 1 sequence<br>3 = Heating 1 sequence, cooling 2 sequences                                                                                                                                                                                                                                                                                                                                                                                                                                                                  | ✓       | ✓       |                                                          | d01 |
| P201                | RDG20..: Output Y1 (and Y3 for 3-pos)<br>RDG26..: Output Y10 (DC) or Q1 (2-<br>pos)                                                  | RDG20..: 4<br>RDG26..: 5 (6<br>when<br>application type<br>is 4-pipe with 6-<br>port ball valve)     | 1 = 3-position                                                                                                                                                                                                                                                                                                                                                                                                                                                                                                                                                                                              | ✓       | -       |                                                          | -   |
|                     |                                                                                                                                      |                                                                                                      | 2 = On/Off (3 wires)                                                                                                                                                                                                                                                                                                                                                                                                                                                                                                                                                                                        | ✓       | -       |                                                          | -   |
|                     |                                                                                                                                      |                                                                                                      | 3 = PWM                                                                                                                                                                                                                                                                                                                                                                                                                                                                                                                                                                                                     | ✓       | -       | -                                                        |     |
|                     |                                                                                                                                      |                                                                                                      | 4 = On/Off                                                                                                                                                                                                                                                                                                                                                                                                                                                                                                                                                                                                  | ✓       | ✓       | -                                                        |     |
|                     |                                                                                                                                      |                                                                                                      | 5 = DC                                                                                                                                                                                                                                                                                                                                                                                                                                                                                                                                                                                                      | -       | ✓       | -                                                        |     |
|                     |                                                                                                                                      |                                                                                                      | 6 = 6-port valve (DC 0...10 V)                                                                                                                                                                                                                                                                                                                                                                                                                                                                                                                                                                              | -       | ✓       | Appl                                                     |     |
|                     |                                                                                                                                      |                                                                                                      | 7 = 6-port valve (DC 2...10 V)                                                                                                                                                                                                                                                                                                                                                                                                                                                                                                                                                                              | -       | ✓       | Appl                                                     |     |
| P203                | RDG20..: Output Y2 (and Y4 for 3-pos)<br>RDG26..: Output Y20 (DC) or Q2 (2-<br>pos)                                                  | RDG20..: 4<br>RDG26..: 5                                                                             | 8 = Inverse signal, 6-port valve (DC 10...0 V)                                                                                                                                                                                                                                                                                                                                                                                                                                                                                                                                                              | -       | ✓       | Appl                                                     |     |
|                     |                                                                                                                                      |                                                                                                      | 9 = Inverse signal 6-port valve (DC 10...2 V)                                                                                                                                                                                                                                                                                                                                                                                                                                                                                                                                                               | -       | ✓       | Appl                                                     |     |
|                     |                                                                                                                                      |                                                                                                      | 10 = 6-port valve (DC 0... 10 V) 3 <sup>rd</sup> part                                                                                                                                                                                                                                                                                                                                                                                                                                                                                                                                                       | -       | ✓       | Appl                                                     |     |
|                     |                                                                                                                                      |                                                                                                      | 11 = 6-port valve (DC 2... 10 V) 3 <sup>rd</sup> part                                                                                                                                                                                                                                                                                                                                                                                                                                                                                                                                                       | -       | ✓       | Appl                                                     |     |
|                     |                                                                                                                                      |                                                                                                      | 1 = 3-position                                                                                                                                                                                                                                                                                                                                                                                                                                                                                                                                                                                              | ✓       | -       | -                                                        |     |
|                     |                                                                                                                                      |                                                                                                      | 2 = On/Off (3 wires)                                                                                                                                                                                                                                                                                                                                                                                                                                                                                                                                                                                        | ✓       | -       | -                                                        |     |
|                     |                                                                                                                                      |                                                                                                      | 3 = PWM                                                                                                                                                                                                                                                                                                                                                                                                                                                                                                                                                                                                     | ✓       | -       | -                                                        |     |
|                     |                                                                                                                                      |                                                                                                      | 4 = On/Off                                                                                                                                                                                                                                                                                                                                                                                                                                                                                                                                                                                                  | ✓       | ✓       | -                                                        |     |
|                     |                                                                                                                                      |                                                                                                      | 5 = DC                                                                                                                                                                                                                                                                                                                                                                                                                                                                                                                                                                                                      | -       | ✓       | -                                                        |     |



| Parameter                            | Name                                                                                                             | Factory setting              | Range                                                                                                                                                                                                                                                                                  | RDG20.. | RDG26.. | Dependencies                                                     |
|--------------------------------------|------------------------------------------------------------------------------------------------------------------|------------------------------|----------------------------------------------------------------------------------------------------------------------------------------------------------------------------------------------------------------------------------------------------------------------------------------|---------|---------|------------------------------------------------------------------|
|                                      | Expert level                                                                                                     |                              |                                                                                                                                                                                                                                                                                        |         |         |                                                                  |
| P204                                 | RDG20...: Output Y3<br>RDG26...: Output Y30 (DC)                                                                 | RDG20...: 4<br>RDG26...: 5   | 3 = PWM                                                                                                                                                                                                                                                                                | ✓       | –       | –                                                                |
|                                      |                                                                                                                  |                              | 4 = On/Off                                                                                                                                                                                                                                                                             | ✓       | ✓       | –                                                                |
|                                      |                                                                                                                  |                              | 5 = DC                                                                                                                                                                                                                                                                                 | –       | ✓       | –                                                                |
| P205                                 | RDG20xKN: Output Y4<br>RDG26xKN: Output U1<br>Note: for 4-pipe 2-stage application                               | RDG20..KN: 4<br>RDG26..KN: 5 | 3 = PWM                                                                                                                                                                                                                                                                                | ✓       | –       | d01                                                              |
|                                      |                                                                                                                  |                              | 4 = On/Off                                                                                                                                                                                                                                                                             | ✓       | –       | d01                                                              |
|                                      |                                                                                                                  |                              | 5 = DC                                                                                                                                                                                                                                                                                 | –       | ✓       | d01                                                              |
| P206 <sup>5)</sup>                   | PWM algorithm cycle Y1                                                                                           | 1200 s                       | 20...3600 s                                                                                                                                                                                                                                                                            | ✓       | –       | P206:<br>P201<br>P207:<br>P203<br>P208:<br>P204<br>P209:<br>P205 |
| P207 <sup>5)</sup>                   | PWM algorithm cycle Y2                                                                                           |                              |                                                                                                                                                                                                                                                                                        |         |         |                                                                  |
| P208 <sup>5)</sup>                   | PWM algorithm cycle Y3                                                                                           |                              |                                                                                                                                                                                                                                                                                        |         |         |                                                                  |
| P209 <sup>5)</sup>                   | PWM algorithm cycle Y4 (RDG2..KN)                                                                                |                              |                                                                                                                                                                                                                                                                                        |         |         |                                                                  |
| P210                                 | On time minimum PWM output                                                                                       | 5 %                          | 1...20 %                                                                                                                                                                                                                                                                               | ✓       | –       | –                                                                |
| P211                                 | Off time minimum PWM output                                                                                      |                              |                                                                                                                                                                                                                                                                                        |         |         |                                                                  |
| P212                                 | On time minimum 2-pos output                                                                                     | 1 min                        | 1...20 min                                                                                                                                                                                                                                                                             | ✓       | ✓       | P400,<br>P401,<br>P402                                           |
| P213                                 | Off time minimum 2-pos output                                                                                    |                              |                                                                                                                                                                                                                                                                                        |         |         |                                                                  |
| P214 <sup>6)</sup>                   | RDG20...: Actuator running time Y1 and Y3 for 3-pos                                                              | 150 s                        | 20...300 s                                                                                                                                                                                                                                                                             | ✓       | –       | P214:<br>P201<br>P215:<br>P203                                   |
| P215 <sup>6)</sup>                   | RDG20...: Actuator running time Y2 and Y4 for 3-pos                                                              |                              |                                                                                                                                                                                                                                                                                        |         |         |                                                                  |
| P217                                 | RDG26...: Power of electric heater on Q2                                                                         | 0 kW                         | 0.0...1.2 kW                                                                                                                                                                                                                                                                           | ✓       | ✓       | P203,<br>P204                                                    |
| <b>Features</b>                      |                                                                                                                  |                              |                                                                                                                                                                                                                                                                                        |         |         |                                                                  |
| P250                                 | Valve kick                                                                                                       | OFF                          | ON = Enabled<br>OFF = Disabled                                                                                                                                                                                                                                                         | ✓       | ✓       | –                                                                |
| P251 <sup>7)</sup><br><sup>10)</sup> | Purge time (every 2 hours)                                                                                       | ---                          | --- (0, Not active), 1...5 min                                                                                                                                                                                                                                                         | M       | M       | P258                                                             |
| P252 <sup>8)</sup>                   | Flow temp limit floor heating                                                                                    | 28 °C (82 °F)                | 10...50 °C (50...122 °F)                                                                                                                                                                                                                                                               | ✓       | ✓       | –                                                                |
| P254 <sup>4)</sup>                   | Swap sequences between H and C (2-pipe / 2-stage)                                                                | OFF                          | ON = Enabled<br>OFF = Disabled                                                                                                                                                                                                                                                         | ✓       | ✓       | P001                                                             |
| P255 <sup>10)</sup>                  | Track setpoint for cooling depends on outside temperature (RDG2..KN)                                             | OFF                          | ON = Enabled<br>OFF = Disabled                                                                                                                                                                                                                                                         | M       | M       | P258                                                             |
| P256                                 | Flow limitation in heating mode for PICV (RDG264KN)<br>Note: Available on devices only with previous SW versions | 10 V                         | 0...10 V                                                                                                                                                                                                                                                                               | –       | ✓       | –                                                                |
| P258                                 | Manager/subordinate (M/S) (RDG2..KN)                                                                             | 1                            | 0 = Subordinate<br>1 = Manager                                                                                                                                                                                                                                                         | ✓       | ✓       | –                                                                |
| P259 <sup>12)</sup>                  | Subordinate identification (RDG2..KN)                                                                            | 1                            | "---"<br>1...9                                                                                                                                                                                                                                                                         | S       | S       | P258                                                             |
| P260                                 | PICV: Heating maximal position (RDG26..)                                                                         | 100 %                        | 0...100 %                                                                                                                                                                                                                                                                              | –       | ✓       | P001                                                             |
| P261                                 | PICV: Cooling maximal position (RDG26..)                                                                         | 100 %                        | 0...100 %                                                                                                                                                                                                                                                                              | –       | ✓       | P001                                                             |
| <b>Fan control</b>                   |                                                                                                                  |                              |                                                                                                                                                                                                                                                                                        |         |         |                                                                  |
| P350                                 | Fan control                                                                                                      | 1                            | 0 = Disabled<br>1 = Enabled<br>2 = Heating only<br>3 = Cooling only<br>4 = 2 <sup>nd</sup> stage<br>5 = Heating and 2 <sup>nd</sup> stage cooling<br>6 = Cooling and 2 <sup>nd</sup> stage heating<br>7 = 2 <sup>nd</sup> stage Cooling only<br>8 = 2 <sup>nd</sup> stage Heating only | ✓       | ✓       | –                                                                |

| Parameter                             | Name                                                    | Factory setting                                              | Range                                                                                                                                                                                                                                                                                                                    | RDG20.                          | RDG26.                          | Dependencies                                               |
|---------------------------------------|---------------------------------------------------------|--------------------------------------------------------------|--------------------------------------------------------------------------------------------------------------------------------------------------------------------------------------------------------------------------------------------------------------------------------------------------------------------------|---------------------------------|---------------------------------|------------------------------------------------------------|
|                                       | Expert level                                            |                                                              |                                                                                                                                                                                                                                                                                                                          |                                 |                                 |                                                            |
| P351                                  | Fan speeds                                              | 3                                                            | 1 = 1-speed fan<br>2 = 3-speed fan<br>3 = DC 0...10 V fan                                                                                                                                                                                                                                                                | ✓                               | ✓                               | P350,<br>P201,<br>P203,<br>P204,<br>P400,<br>P401,<br>P402 |
| P352                                  | Fan overrun time                                        | 2-pipe/4-pipe el.<br>Heater: 60 s<br>Other applications: 0 s | 0...600 s                                                                                                                                                                                                                                                                                                                | ✓                               | ✓                               | P350                                                       |
| P353                                  | Fan speed switching point low                           | 10 %                                                         | 1 %...Fan speed 2 (P354)                                                                                                                                                                                                                                                                                                 | ✓                               | ✓                               | P350                                                       |
| P354                                  | Fan speed switching point med                           | 65 %                                                         | Fan speed 1 (P353)...fan speed 3 (P355)                                                                                                                                                                                                                                                                                  | ✓                               | ✓                               | P350,<br>P351                                              |
| P355                                  | Fan speed switching point high                          | 100 %                                                        | Fan speed 2 (P354)...100 %                                                                                                                                                                                                                                                                                               | ✓                               | ✓                               | P350,<br>P351                                              |
| P356                                  | DC fan switching point                                  | DC: 10 %                                                     | DC: 1...100 %                                                                                                                                                                                                                                                                                                            | ✓                               | ✓                               | P350                                                       |
| P357                                  | DC fan speed low min. output                            | DC: 30 %                                                     | DC: 1 %...Fan speed med (P358)                                                                                                                                                                                                                                                                                           | ✓                               | ✓                               | P350                                                       |
| P358                                  | DC fan speed med output                                 | DC: 60 %                                                     | DC: fan speed low (P357)...fan speed high(lower value of P359 and P360)                                                                                                                                                                                                                                                  | ✓                               | ✓                               | P350                                                       |
| P359                                  | DC fan speed high max. out. heat                        | DC: 80 %                                                     | DC: fan speed med (P358)...100 %                                                                                                                                                                                                                                                                                         | ✓                               | ✓                               | P350                                                       |
| P360                                  | DC fan speed high max. out.cool                         |                                                              |                                                                                                                                                                                                                                                                                                                          |                                 |                                 |                                                            |
| P361                                  | Fan start kick                                          | ON                                                           | ON: Enabled<br>OFF: Disabled                                                                                                                                                                                                                                                                                             | ✓                               | ✓                               | P350                                                       |
| P362                                  | On time minimum fan                                     | 2 min                                                        | 1...6 min                                                                                                                                                                                                                                                                                                                | ✓                               | ✓                               | P350                                                       |
| P363                                  | Periodic fan kick Comfort                               | ---                                                          | 1...89 min, --- (0)                                                                                                                                                                                                                                                                                                      | ✓                               | ✓                               | P350                                                       |
| P364                                  | Periodic fan kick Economy                               | ---                                                          | 0...359 min, ---                                                                                                                                                                                                                                                                                                         | ✓                               | ✓                               | P350                                                       |
| P365                                  | Fan start delay                                         | 0 s                                                          | 0...360 s                                                                                                                                                                                                                                                                                                                | ✓                               | ✓                               | P350                                                       |
| P366                                  | Fan start, minimum water temperature                    | 30 °C                                                        | --- (0),5...60 °C                                                                                                                                                                                                                                                                                                        | ✓                               | ✓                               | P350<br>Input                                              |
| <b>Relay functions</b>                |                                                         |                                                              |                                                                                                                                                                                                                                                                                                                          |                                 |                                 |                                                            |
| P400 <sup>9)</sup>                    | Output Q1 function<br>RDG2..KN: 0...8<br>RDG2..T: 0...6 | 0                                                            | 0 = No function<br>1 = Switch OFF in Protection<br>2 = Switch ON in Heat/Cool demand<br>3 = Switch ON in Heat demand<br>4 = Switch ON in Cool demand<br>5 = Heating sequence active<br>6 = Cooling sequence active<br>7 = External dehumidifier control <sup>10)</sup><br>8 = External humidifier control <sup>10)</sup> | ✓                               | ✓                               | P350,<br>P351,<br>P258                                     |
| P401 <sup>9)</sup>                    | Output Q2 function<br>RDG2..KN: 0...8<br>RDG2..T: 0...6 |                                                              |                                                                                                                                                                                                                                                                                                                          | ✓                               | ✓                               |                                                            |
| P402 <sup>21)</sup>                   | Output Q3 function<br>RDG2..KN: 0...8<br>RDG2..T: 0...6 |                                                              |                                                                                                                                                                                                                                                                                                                          | ✓                               | ✓                               |                                                            |
| <b>Controller</b>                     |                                                         |                                                              |                                                                                                                                                                                                                                                                                                                          |                                 |                                 |                                                            |
| P450 <sup>15)</sup>                   | Control strategy (RDG2..KN)                             | RDG200KN &<br>RDG260KN: 0<br><br>RDG204KN &<br>RDG264KN: 2   | 0 = Temperature (T)<br>1 = Temperature (T) + Relative humidity (r.h.)<br>2 = Temperature (T) + Air quality (IAQ) <sup>13)</sup><br>3 = Temperature + Humidity + Air quality <sup>13)</sup><br>4 = T.+ Air quality (damper, fan)<br>5 = T + Air quality + Air cooling<br>6 = T + Air quality + 2nd air cool               | ✓<br>M<br>✓<br>M<br>M<br>M<br>M | ✓<br>M<br>✓<br>M<br>M<br>M<br>M | P258                                                       |
| P451 <sup>10)</sup>                   | Humidity control strategy (RDG2..KN)                    | 2                                                            | 1 = With setpoint shift<br>2 = With setpoint shift + external equipment (humid / dehum)                                                                                                                                                                                                                                  | M                               | M                               | P450,<br>P258                                              |
| P453 <sup>13)</sup><br><sup>16)</sup> | Indoor air quality damper (RDG2..KN)                    | 1 <sup>14)</sup>                                             | 1 = DC 0...10 V (U1)<br>2 = On/Off (normally open)<br>3 = On/Off (normally closed)                                                                                                                                                                                                                                       | ✓                               | ✓                               | P450                                                       |
| P454 <sup>13)</sup><br><sup>16)</sup> | IAQ damper P-band Xp (RDG2..KN)                         | 400 ppm (CO <sub>2</sub> )                                   | 10...2000 ppm (CO <sub>2</sub> )                                                                                                                                                                                                                                                                                         | ✓                               | ✓                               | P450                                                       |
| P455 <sup>13)</sup><br><sup>16)</sup> | Minimum damper position (RDG2..KN)                      | 0 %                                                          | 0...P457                                                                                                                                                                                                                                                                                                                 | ✓                               | ✓                               | P450                                                       |
| P456 <sup>13)</sup><br><sup>16)</sup> | IAQ fan P-band Xp (RDG2..KN)                            | 400 ppm (CO <sub>2</sub> )                                   | 10...2000 ppm (CO <sub>2</sub> )                                                                                                                                                                                                                                                                                         | ✓                               | ✓                               | P450                                                       |
| P457 <sup>16)</sup>                   | Maximum damper position                                 | 100 %                                                        | P455...100 %                                                                                                                                                                                                                                                                                                             | ✓                               | ✓                               | P450,<br>P453                                              |

| Parameter            | Name                                           | Factory setting | Range                                     | RDG20.. | RDG26.. | Dependencies  |
|----------------------|------------------------------------------------|-----------------|-------------------------------------------|---------|---------|---------------|
|                      | Expert level                                   |                 |                                           |         |         |               |
| P458 <sup>17)</sup>  | Fan during IAQ control                         | ON              | ON = Enabled<br>OFF = Disabled            | ✓       | ✓       | P450          |
| P461 <sup>10)</sup>  | T setpoint shift (humidity) (RDG2..KN)         | 3 K             | -3...3 K                                  | M       | M       | P450,<br>P258 |
| <b>Side Features</b> |                                                |                 |                                           |         |         |               |
| P500                 | NFC                                            | ON              | ON = Enabled<br>OFF = Disabled            | ✓       | ✓       | -             |
| P501 <sup>10)</sup>  | Service filter                                 | ---             | --- (OFF), 100...9900 h                   | M       | M       | P350,<br>P258 |
| P502                 | Password                                       | OFF             | ON = Enabled<br>OFF = Disabled            | ✓       | ✓       | -             |
| P503                 | Password                                       | 000             | 000...999                                 | ✓       | ✓       | -             |
| P505                 | Reset parameter setting                        | OFF             | OFF = Disabled<br>ON = Reload start       | ✓       | ✓       | -             |
| P506 <sup>18)</sup>  | Reset device                                   | OFF             | OFF = Disabled<br>ON = Reload start       | ✓       | ✓       | -             |
| <b>System</b>        |                                                |                 |                                           |         |         |               |
| P898                 | Area address (RDG2..KN)                        | 0               | 0...15                                    | ✓       | ✓       | -             |
| P899                 | Line address (RDG2..KN)                        | 2               | 0...15                                    | ✓       | ✓       | -             |
| P900                 | Device address 3) (RDG2..KN)                   | 255             | 1...255                                   | ✓       | ✓       | -             |
| P901                 | Geographical zone (apartment) 4)<br>(RDG2..KN) | ---             | ---(0), 1...126                           | ✓       | ✓       | -             |
| P902                 | Geographical zone (room) 3)<br>(RDG2..KN)      | 1               | ---(0), 1...63                            | ✓       | ✓       | -             |
| P903                 | Heat distr zone heating coil<br>(RDG2..KN)     | ---             | ---(0), 1...31                            | ✓       | ✓       | -             |
| P904                 | Refrig distr zone cooling coil<br>(RDG2..KN)   |                 |                                           |         |         |               |
| P905                 | Heat distr zone heating surface<br>(RDG2..KN)  |                 |                                           |         |         |               |
| P910                 | Transformation Precomfort<br>(RDG2..KN)        | 0               | 0 = Economy <sup>10)</sup><br>1 = Comfort | M       | M       | P258          |

Note: Appl means application.

- 1) When P201/P203 = 1/3/5, P204/P205 = 3/5, P057 & P058 are visible.
- 2) When P150, P153 or P155 = 2 and P001 = 2, P059 & P060 are visible.
- 3) For KNX version: When P002 ≠ 2 and P005 ≠ ON, P102 is visible.  
For standalone version: When P002 = 4, P102 is visible.
- 4) Only available for application 2-pipe/2-stage.
- 5) When P201 = 3, P206 is visible; P203 = 3, P207 is visible; P204 = 3, P208 is visible; P205 = 3, P209 is visible.
- 6) When P201 = 1, P214 is visible; P203 = 1, P215 is visible.
- 7) When "H/C changeover" function on X1, X2, U1 is selected, P251 is visible.
- 8) When "External temperature limit (AI)" on X1, X2, U1 is selected, P252 is visible.
- 9) When application is 4-pipe with 6-port ball valve as changeover and PICV, P400 & P401 are invisible.
- 10) If P258 = 0 (Subordinate), the parameter values are not visible.
- 11) Only available for applications 2-pipe, 2-pipe with electric heater and 2-pipe with radiator.
- 12) If P258 = 0 (Subordinate), the parameter values are visible.
- 13) The parameters are valid for RDG204KN and RDG264KN.
- 14) For RDG264KN, the parameter factory setting is 2 for the 4-pipe/2-stage application.
- 15) For RDG204KN and RDG264KN, values 0 and 2 are visible for P258 = 0 (Subordinate). Values 4...6 are visible for P453 = 1 (DC damper).
- 16) When P450 = 2...6 and P453 = 1, P457 is visible.

- 17) When P450 = 2...6, P458 is visible.  
 18) PL-Link reset device is available only on HMI on RDG2..0KN index E or higher and RDG2..4KN index C or higher. When P506 = ON, all parameters are factory reset including device address.  
 19) When P450 = 2...6 with IAQ control and P350 ≠ 0, P109 is visible.  
 20) When P450 = 2...6 with IAQ control and P453 = 1 (DC damper), P155 is invisible.  
 21) When P450 = 2...6 with IAQ control, P350 = 1, P351 = 3 and P453 = 1 (DC damper), P402 is visible.

### Diagnostics and test

| Parameter         | Name                                                             | Range                                                                                                                                                                                                                                                                                        | Dependencies |
|-------------------|------------------------------------------------------------------|----------------------------------------------------------------------------------------------------------------------------------------------------------------------------------------------------------------------------------------------------------------------------------------------|--------------|
|                   | <b>Diagnostics and test</b>                                      |                                                                                                                                                                                                                                                                                              |              |
| d01               | Application number                                               | 0 = (No application)<br>1 = 2-pipe<br>2 = 2-pipe with electric heater<br>3 = 2-pipe with radiator<br>4 = 4-pipe<br>5 = 2-pipe / 2-stage<br>6 = 4-pipe with electric heater<br>7 = 4-pipe / 2-stage (RDG2..KN)<br>8 = 4-pipe:6-port H/C<br>9 = 4-pipe:6-port CO +PICV<br>10 = 4-pipe 6vw PICV | –            |
| d02               | X1 state                                                         | "---" = Function not selected<br>0 = Not activated (for DI)<br>1 = Activated (DI)<br>0...49 °C = Current temp. value (for AI)<br>00 ❄️ = H/C Input shorted<br>100 🌀 = H/C Input open                                                                                                         | –            |
| d03               | X2 state                                                         | "---" = Function not selected<br>0 = Not activated (for DI)<br>1 = Activated (DI)<br>0...49 °C = Current temp. value (for AI)<br>00 ❄️ = H/C Input shorted<br>100 🌀 = H/C Input open                                                                                                         | –            |
| d04               | U1 state                                                         | "---" = Function not selected<br>0 = Not activated (for DI)<br>1 = Activated (DI)<br>2 = Activated (DC input)<br>3 = Activated (DC output)<br>0...49 °C = Current temp. value (for AI)<br>00 ❄️ = H/C Input shorted<br>100 🌀 = H/C Input open                                                | –            |
| d05 <sup>1)</sup> | Test mode for checking the Y1/Y3 actuator's running direction 5) | "---" = No signal on outputs Y1 and Y3<br>OPE = Output Y1 forced opening<br>CLO = Output Y3 forced closing                                                                                                                                                                                   | –            |
| d06 <sup>1)</sup> | Test mode for checking the Y2/Y4 actuator's running direction 5) | "---" = No signal on outputs Y2 and Y4<br>OPE = Output Y2 forced opening<br>CLO = Output Y4 forced closing                                                                                                                                                                                   | –            |
| d08               | Test mode for checking the Q1 output (ex P400 function)          | "---" = no signal at output Q1<br>OPE = output Q1 forced opening<br>CLO = output Q1 forced closing                                                                                                                                                                                           | –            |
| d09               | Test mode for checking the Q2 output (ex P401 function)          | "---" = no signal at output Q2<br>OPE = output Q2 forced opening<br>CLO = output Q2 forced closing                                                                                                                                                                                           | –            |
| d10               | Test mode for checking the Q3 output (ex P402 function)          | "---" = no signal at output Q3<br>OPE = output Q3 forced opening<br>CLO = output Q3 forced closing                                                                                                                                                                                           | –            |
| d14               | Firmware version                                                 | v x-x-x is displayed                                                                                                                                                                                                                                                                         | –            |
| d15               | Unit ID number (Serial number)                                   | Unit ID is displayed (Serial number)                                                                                                                                                                                                                                                         | –            |
| d16               | Bootloader version (RDG2..KN)                                    | v x-x-x is displayed                                                                                                                                                                                                                                                                         | –            |
| d17               | Touch firmware version                                           | v x-x-x is displayed                                                                                                                                                                                                                                                                         | –            |
| d18               | LCD version                                                      | –                                                                                                                                                                                                                                                                                            | –            |

Note: Parameter display depends on selected application and function.

<sup>1)</sup> When output type is 3-position/3-wire, d05 and d06 are visible.

## 5 Supported tools

Valid set of versions

| RDG200KN<br>RDG260KN | Product no.                |                      |                            |                    | Supported tools |                            |                       |                       |                    |                    |
|----------------------|----------------------------|----------------------|----------------------------|--------------------|-----------------|----------------------------|-----------------------|-----------------------|--------------------|--------------------|
|                      | RDG200KN/BK<br>RDG260KN/BK | RDG204KN<br>RDG264KN | RDG204KN/BK<br>RDG264KN/BK | RDG200T<br>RDG260T | ACS             | ETS                        | PCT Go An-<br>droid   | PCT Go Ap-<br>ple     | For Desigo PXC     |                    |
|                      |                            |                      |                            |                    |                 |                            |                       |                       | ABT<br>Site        | ABT<br>Go          |
| Z, A                 | -                          | -                    | -                          | -                  | ≥13.0           | 1.0                        | ≥V1.11.5              | ≥V1.11.5              | -                  | -                  |
| B                    | -                          | -                    | -                          | -                  | ≥14.1           | 2.0                        | ≥V3.1.7               | ≥V3.1.7               | -                  | -                  |
| -                    | Z, A                       | -                    | -                          | -                  | ≥14.1           | 2.0                        | ≥V3.1.7               | ≥V3.1.7               | -                  | -                  |
| -                    | -                          | Z, A                 | -                          | -                  | ≥14.1           | 2.0                        | ≥V3.1.7               | ≥V3.1.7               | -                  | -                  |
| D                    | D                          | -                    | -                          | -                  | ≥14.1           | 2.1                        | ≥V7.1.0               | ≥V7.1.0               | -                  | -                  |
| -                    | -                          | -                    | -                          | Z, A               | N/A             | N/A                        | ≥V7.1.0               | ≥V7.1.0               | -                  | -                  |
| -                    | -                          | B                    | -                          | -                  | ≥14.2           | 2.1                        | ≥V7.1.0               | ≥V7.1.0               | -                  | -                  |
| E                    | E                          | -                    | -                          | -                  | ≥14.4           | V3.0<br>V3.1 <sup>2)</sup> | ≥V7.2.6 <sup>1)</sup> | ≥V7.2.6 <sup>1)</sup> | V5.2 <sup>1)</sup> | V5.2 <sup>1)</sup> |
| -                    | -                          | C                    | C                          | -                  | ≥14.4           | V3.0                       | ≥V7.2.6 <sup>1)</sup> | ≥V7.2.6 <sup>1)</sup> | V5.2 <sup>1)</sup> | V5.2 <sup>1)</sup> |

<sup>1)</sup> RDG commissioning for PXC4, 5, or 7 integration must be done via ABT Site. PCT Go must not be used.

<sup>2)</sup> V3.1 supports RDG260KN only.

To commission and modify older RDG SW versions, see workflow in PCT Go – Smartphone app [→ 183].

### Important!

If a controller had been tooled with ABT Site and later to be used in combination with ACS / ETS, parameter P506 reset on RDG HMI is needed.

## 5.1 ETS



ETS

ETS is an engineering tool to fully commission RDG2..KN room thermostats.

ETS can implement the following functions:

- Define and download the physical address
- Define and download the application (plant type, control sequence)
  - For partial download, ensure the application uses the same DIP switch setting
- Set up and download thermostat control parameters
- Set up and download group addresses

This document does not describe how to operate ETS and set up a device. Refer to the KNX Manual [5] [→ 6] for more details.

**ETS can be updated online.**



Note!

## 5.1.1 Setting parameters in ETS

- 1 Open the project in ETS and select a device.
- 2 Click the **Parameter** tab, and adjust the control parameters as follows:

| --- RDG204KN Room Thermostat > Device |                                                                                                          |
|---------------------------------------|----------------------------------------------------------------------------------------------------------|
| Basic Configuration                   | [P002] Operation via room operating mode selector <span>Auto - Comf - Eco - Prot</span>                  |
| <b>Device</b>                         | [P003] Operation via fan operating selector <span>Auto - Manual</span>                                   |
| Room Operating Mode                   | [P004] Unit <input checked="" type="radio"/> Degrees Celsius <input type="radio"/> Degrees Fahrenheit    |
| Room Temperature and Setpoi...        | [P005] Scheduler <input checked="" type="radio"/> Disabled <input type="radio"/> Enabled                 |
| Room Relative Humidity                | [P008] Standard display <input checked="" type="radio"/> Room temperature <input type="radio"/> Setpoint |
| Controller                            | [P009] Additional display information <span>Humidity (%)</span>                                          |
| Alarm                                 | [P017] Summer time <span>Europe</span>                                                                   |
| Inputs                                | [P028] Keypad <span>Unlocked</span>                                                                      |
| Outputs                               | [P030] Buzzer function <input type="radio"/> Disabled <input checked="" type="radio"/> Enabled           |
| Fan                                   | [P031] Language <span>English</span>                                                                     |
|                                       | [P500] NFC <input type="radio"/> Disabled <input checked="" type="radio"/> Enabled                       |
|                                       | [P502] Password <input checked="" type="radio"/> Disabled <input type="radio"/> Enabled                  |
|                                       | [P901] Geographical zone (apartment) <span>-----</span>                                                  |
|                                       | [P902] Geographical zone (room) <span>1</span>                                                           |

Group Objects    Parameter

### 3 Plant type (application), Control Sequence and other control parameters ([Pxx] description) can be downloaded.

--- RDG204KN Room Thermostat > Basic Configuration

|                                |                                    |                                                                                                     |
|--------------------------------|------------------------------------|-----------------------------------------------------------------------------------------------------|
| Basic Configuration            | [DIP] Plant type                   | 4-pipe                                                                                              |
| Device                         | [P001] Control sequence            | <input type="radio"/> H/C changeover manual<br><input checked="" type="radio"/> Heating and cooling |
| Room Operating Mode            | [P258] Manager / Subordinate (M/S) | <input type="radio"/> Subordinate <input checked="" type="radio"/> Manager                          |
| Room Temperature and Setpoints | [P450] Control strategy            | Temp. (T) + Humidity (r.H)                                                                          |
| Room Relative Humidity         |                                    |                                                                                                     |
| Controller                     |                                    |                                                                                                     |
| Alarm                          |                                    |                                                                                                     |
| Inputs                         |                                    |                                                                                                     |
| Outputs                        |                                    |                                                                                                     |
| Fan                            |                                    |                                                                                                     |

For more details on control parameters, see Control parameters [→ 163].

#### Notes

- ETS version 4 or higher is used to assign communication objects to group addresses (S-Mode)
- ETS version 4 or higher is used to download the application and parameters

#### Humidity parameters

- 1 Select **Room relative humidity** in the left pane to display humidity parameters.
- 2 Adjust the parameters as needed. See Control parameters [→ 163] for more details on control parameters.

--- RDG204KN Room Thermostat > Room Relative Humidity

|                                |                                           |                                                                                                                                 |
|--------------------------------|-------------------------------------------|---------------------------------------------------------------------------------------------------------------------------------|
| Basic Configuration            | Humidity setpoints                        | <input type="radio"/> As parameters only <input checked="" type="radio"/> As group object                                       |
| Device                         | [P451] Humidity control strategy          | <input type="radio"/> With setpoint shift<br><input checked="" type="radio"/> With setpoint shift + external equipment (humi... |
| Room Operating Mode            | [P461] Temp setpoint shift (humidity) [K] | 3.0 K                                                                                                                           |
| Room Temperature and Setpoints | [P024] Humidity setpoint high [%]         | 50%                                                                                                                             |
| Room Relative Humidity         | [P026] Humidity setpoint low [%]          | -----                                                                                                                           |
| Controller                     |                                           |                                                                                                                                 |
| Alarm                          |                                           |                                                                                                                                 |
| Inputs                         |                                           |                                                                                                                                 |
| Outputs                        |                                           |                                                                                                                                 |
| Fan                            |                                           |                                                                                                                                 |

- 3 Select **as group object** in checkbox **Humidity setpoints**, to display the S-Mode humidity setpoint in the **Group Objects** tab as follows:

|    |                                   |         |         |
|----|-----------------------------------|---------|---------|
| 79 | Room rel. humidity: Setpoint high | Receive | 2 bytes |
| 80 | Room rel. humidity: Setpoint low  | Receive | 2 bytes |

## 5.2 ACS tool



ACS



Note!

The ACS tool is used to commission the RDG2..KN KNX room thermostats (physical address, application, parameters). They can be operated or monitored by bus during normal operation.

This section does not describe how to define the physical address and only provides a brief overview of ACS main function.

For more information, refer to the ACS online help.

**Setting RDG2..KN KNX parameters is only supported by ACS version 13.03 or higher.**

### 5.2.1 Setting parameters in ACS

In the ACS program, select **Plant** → **Open** to open the plant.

To open the parameter settings, select **Applications** → **Plant engineering**.

The screenshot shows the ACS Tool interface for project 'RDG200&260'. The 'Applications' menu is open, highlighting 'Plant engineering...'. The main window shows project status and details:

Project status: Get started | Service contact

Project: RDG200&260 [Edit project properties...]

Categories:

Description:

Project type: KNX (KNX bus)

| Communication | Device                      | Address | Connection type | Details       |
|---------------|-----------------------------|---------|-----------------|---------------|
| Disconnected  | OCI700 (KNX cable) / OCI702 |         | USB             | OCI700 [V1.0] |

Number of devices: 3  
Not found: 0

Current view: Administration  
Startup view: Administration

The application and control parameters can be adjusted and downloaded.

**Line no.** contains the parameter number as displayed in the parameter table. See Control parameters [→ 163].



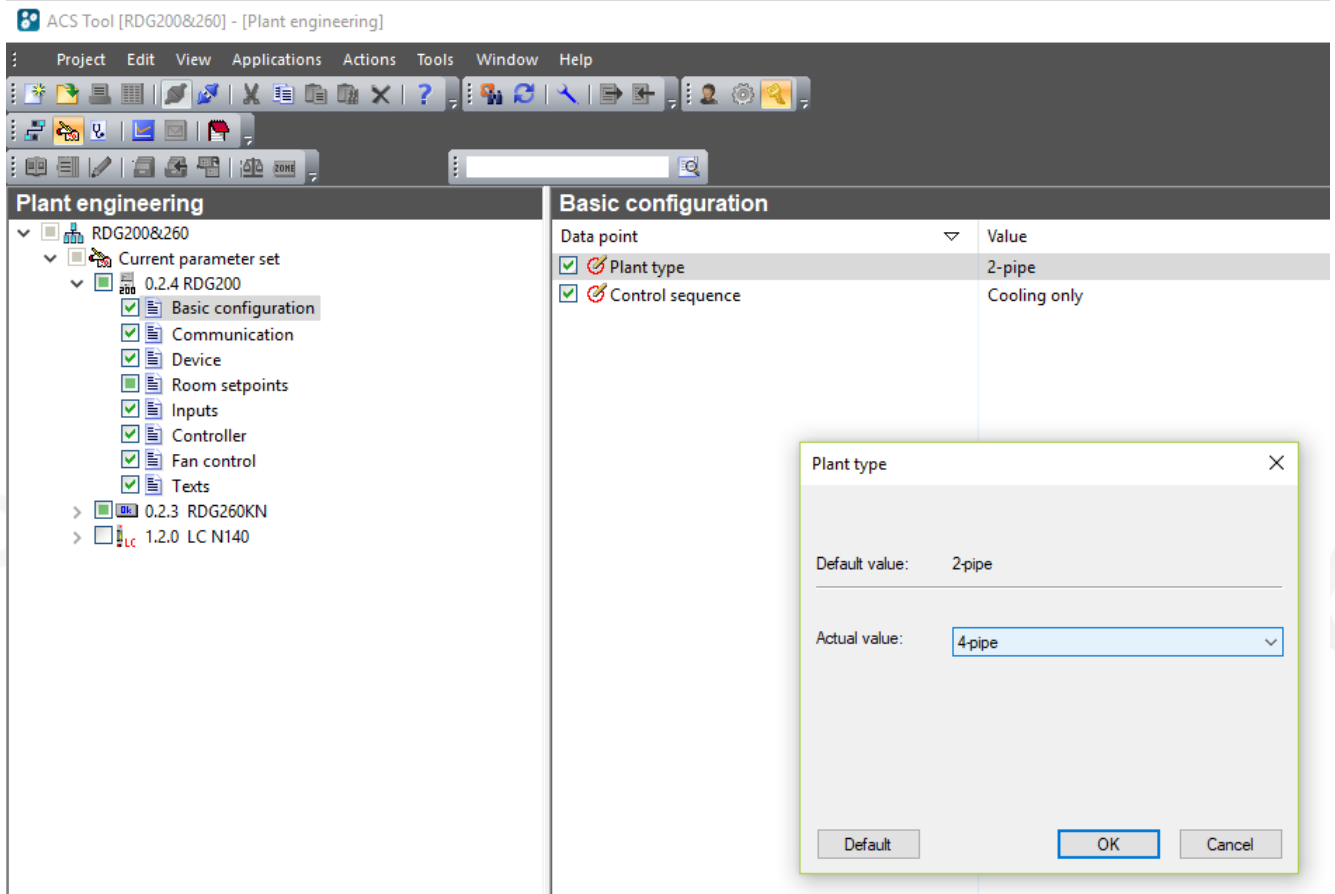

**Note!**

Some parameters in ACS have a range different from that on the room thermostats.

The thermostat does not accept changes outside its range. This can be seen online in that a changed value returns to the original value.

Use the ranges described in the parameter tables in Control parameters [→ 163].

## 5.2.2 Operation and monitoring with ACS



**ACS**

In the ACS program, select **Plant** → **Open** to open the plant.

To open monitoring and operation, select **Applications** → **Plant operation**.

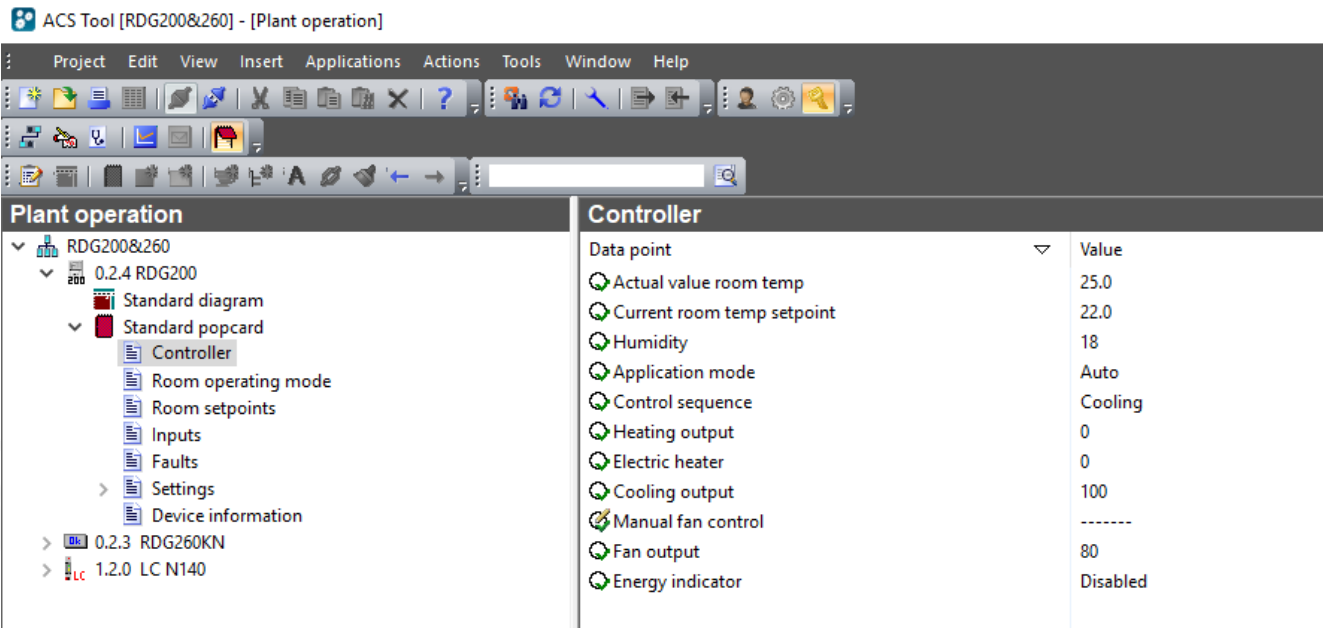

### Parameter settings in ACS

The ACS tool supports parameter settings even during normal operation. To change a control parameter, double-click the parameter in **Standard popcard** for the settings.

### Notes

- Make sure you are logged in with sufficient access right.
- Only control parameters can be changed, not the application!

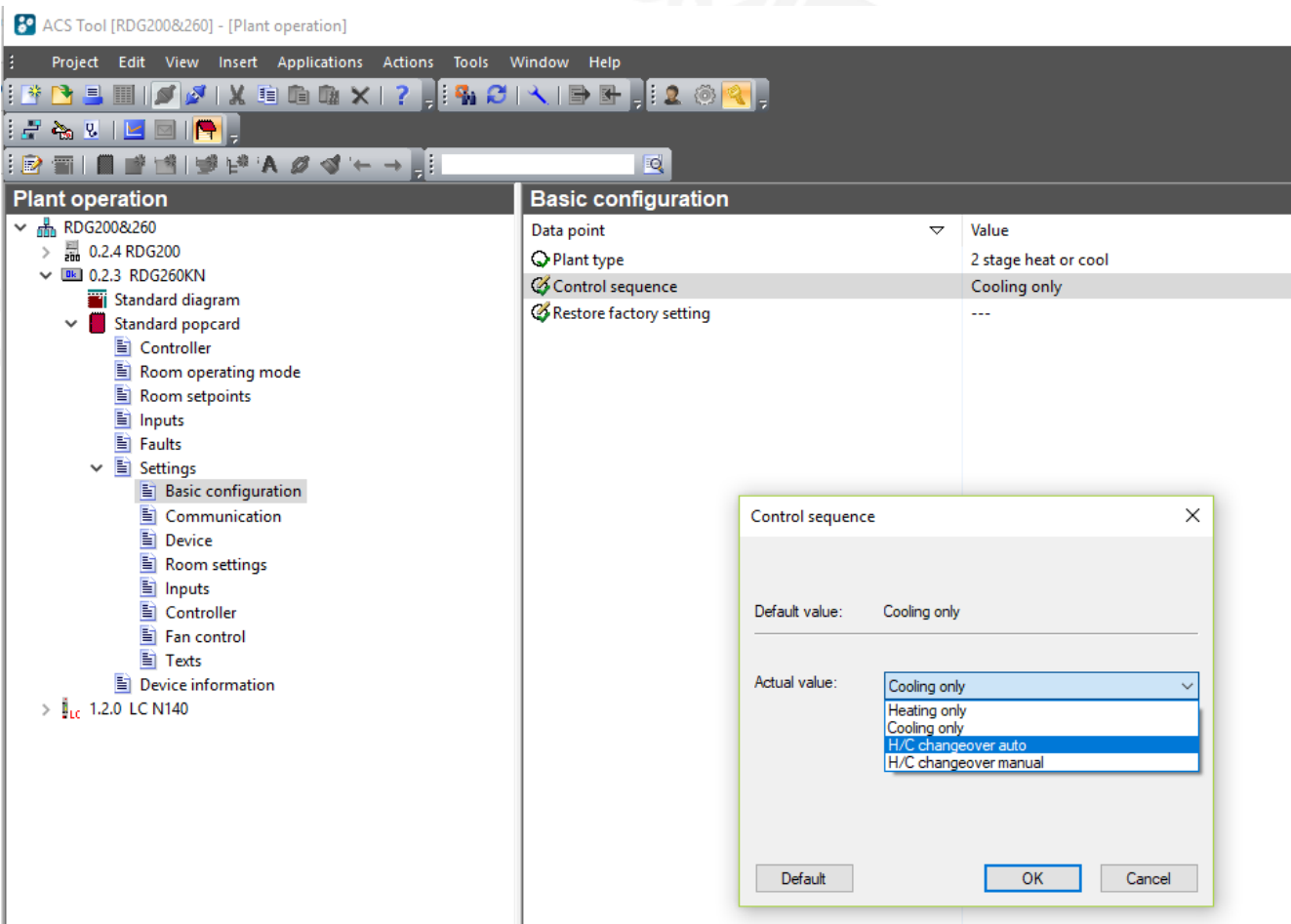



### Plant diagram in ACS

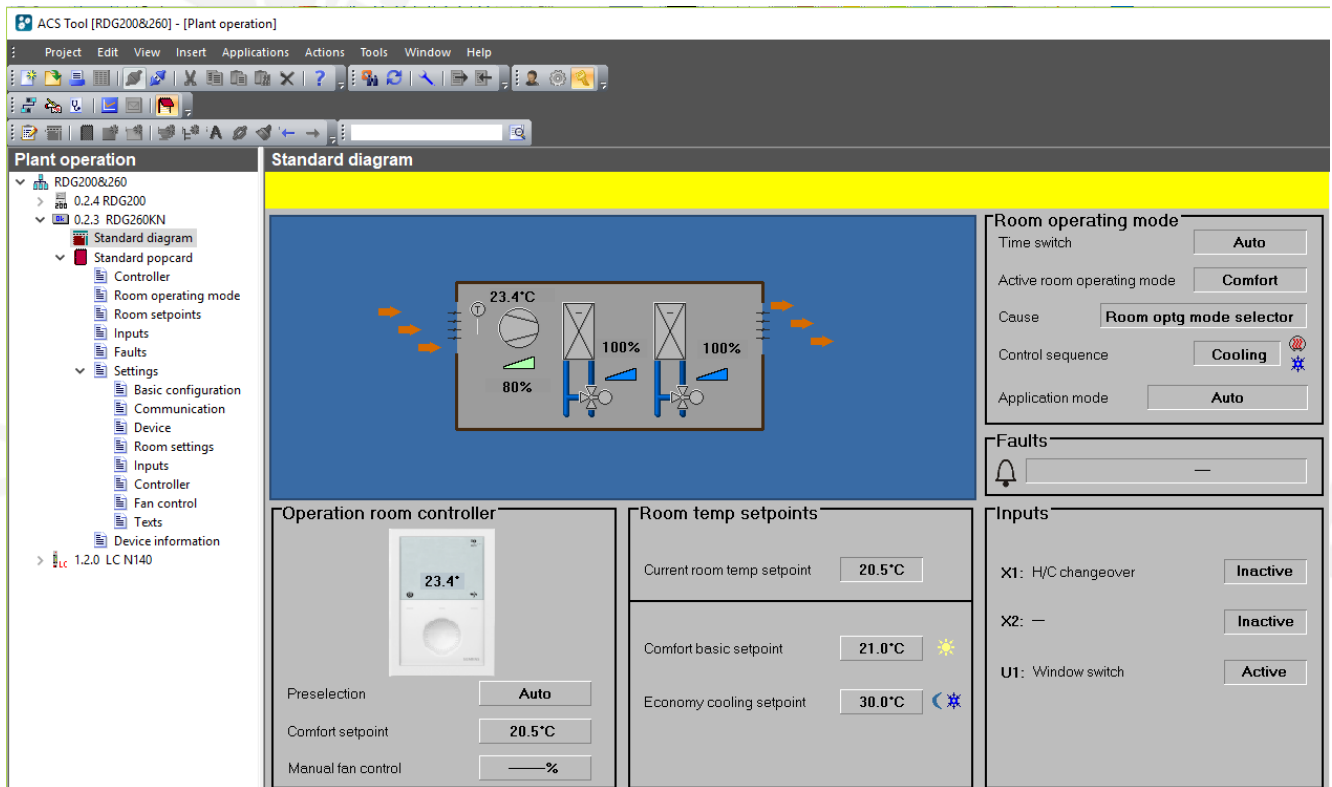

The ACS tool offers plant diagrams for easy monitoring and operation of the thermostat.

To start the application, select **Applications → Plant operation → Standard diagram**.

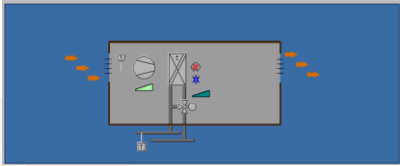

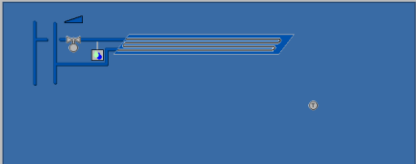
The ACS tool provides standard plant diagrams for RDG2..KN room thermostats, depending on the following configuration:

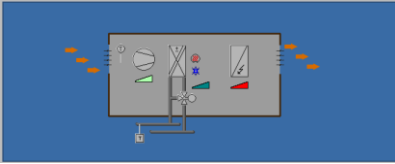
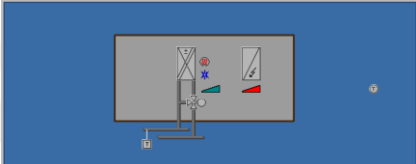
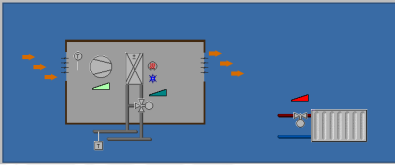
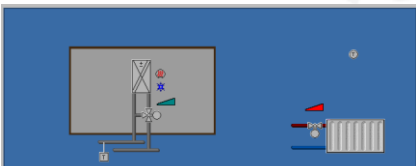
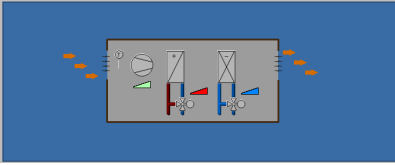
| Plant type | Application configuration                                                                                                                                                                                                          | Application configuration                                                                                                                                                                             |
|------------|------------------------------------------------------------------------------------------------------------------------------------------------------------------------------------------------------------------------------------|-------------------------------------------------------------------------------------------------------------------------------------------------------------------------------------------------------|
| 2-pipe     | <b>2-pipe fan coil unit</b><br>– Control sequence: No impact (P001 = any)<br>– Fan operation: Enabled (P350 <math>\leftrightarrow 0</math>)<br> | <b>Radiator</b><br>– Control sequence: Heating only (P001 = 0)<br>– Fan operation: Disabled (P350 = 0)<br>        |
|            | <b>Chilled/heated ceiling</b><br>– Control sequence: Changeover<br>– Fan operation: Disabled (P350 = 0)<br>                                     | <b>Chilled ceiling</b><br>– Control sequence: Cooling only (P001 = 1)<br>– Fan operation: Disabled (P350 = 0)<br> |

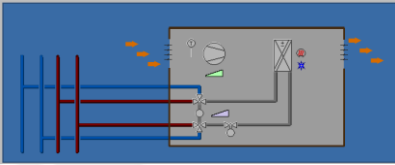
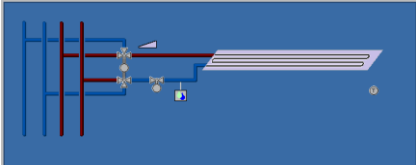
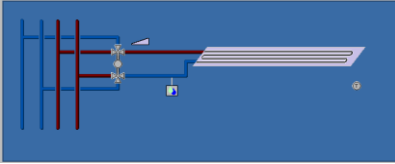
| Plant type                  | Application configuration                                                                                                                                                                                                                                                                  | Application configuration                                                                                                                                                                                                                                                     |
|-----------------------------|--------------------------------------------------------------------------------------------------------------------------------------------------------------------------------------------------------------------------------------------------------------------------------------------|-------------------------------------------------------------------------------------------------------------------------------------------------------------------------------------------------------------------------------------------------------------------------------|
| 2-pipe with electric heater | <p><b>2-pipe fan coil unit with electric heater</b></p> <ul style="list-style-type: none"> <li>– Control sequence: No impact (P001 = any)</li> <li>– Fan operation: Enabled (P350 &lt;&gt; 0)</li> </ul>  | <p><b>Single-stage with electric heater</b></p> <ul style="list-style-type: none"> <li>– Control sequence: No impact (P001 = any)</li> <li>– Fan operation: Disabled (P350 = 0)</li> </ul>  |
| 2-pipe with radiator        | <p><b>2-pipe fan coil unit with radiator</b></p> <ul style="list-style-type: none"> <li>– Control sequence: No impact (P001 = any)</li> <li>– Fan operation: Enabled (P350 &lt;&gt; 0)</li> </ul>         | <p><b>Single-stage with radiator</b></p> <ul style="list-style-type: none"> <li>– Control sequence: No impact (P001 = any)</li> <li>– Fan operation: Disabled (P350 = 0)</li> </ul>         |
| 4-pipe                      | <p><b>4-pipe fan coil unit</b></p> <ul style="list-style-type: none"> <li>– Control sequence: Not auto c/o (P001 &lt;&gt; 3)</li> <li>– Fan operation: Enabled (P350 &lt;&gt; 0)</li> </ul>             | <p><b>Chilled ceiling with radiator</b></p> <ul style="list-style-type: none"> <li>– Control sequence: No impact (P001 = any)</li> <li>– Fan operation: Disabled (P350 = 0)</li> </ul>    |
|                             | <p><b>4-pipe fan coil unit with PICV and 6-port control ball valve as changeover</b></p> <ul style="list-style-type: none"> <li>– Fan operation: Must be enabled (P350 &lt;&gt; 0)</li> </ul>           | <p><b>H/C ceiling with PICV and 6-port control ball valve as changeover</b></p> <ul style="list-style-type: none"> <li>– Fan operation: Disabled (P350 = 0)</li> </ul>                    |
|                             | <p><b>H/C ceiling with 6-port valve</b></p> <ul style="list-style-type: none"> <li>– Fan operation: Disabled (P350 = 0)</li> </ul>                                                                      |                                                                                                                                                                                                                                                                               |

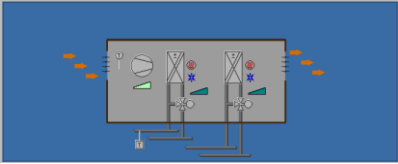
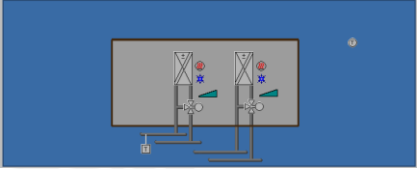
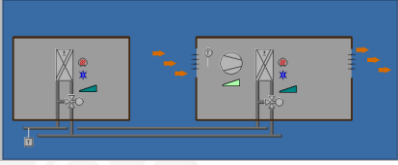
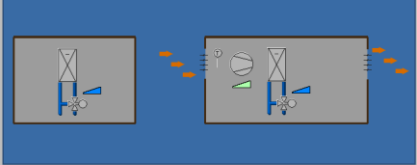
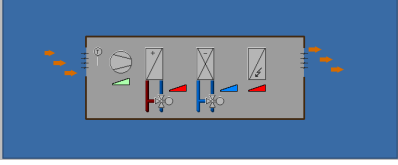
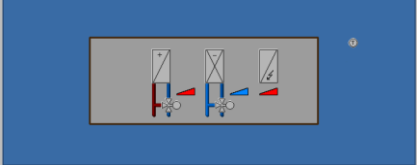
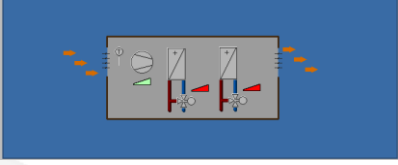
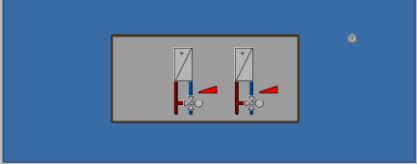
| Plant type                        | Application configuration                                                                                                                                                                                                      | Application configuration                                                                                                                                                                                                      |
|-----------------------------------|--------------------------------------------------------------------------------------------------------------------------------------------------------------------------------------------------------------------------------|--------------------------------------------------------------------------------------------------------------------------------------------------------------------------------------------------------------------------------|
| 2-pipe/2-stage heating or cooling | <b>2-pipe/2-stage fan coil unit</b><br>– Control sequence: No impact (P001 = any)<br>– Fan operation: Enabled (P350 <> 0)<br>                 | <b>2-pipe/2-stage</b><br>– Control sequence: No impact (P001 = any)<br>– Fan operation: Disabled (P350 = 0)<br>                              |
|                                   | <b>2-pipe/2-stage fan coil unit</b><br>– Control sequence: No impact (P001 = any)<br>– Fan operation: 2 <sup>nd</sup> stage (P350 = 4)<br>    | <b>2-pipe/2-stage</b><br>– Control sequence: No impact (P001 = any)<br>– Fan operation: 2 <sup>nd</sup> stage (P350 = 5)<br>                 |
| 4-pipe with electric heater       | <b>4-pipe fan coil unit with electric heater</b><br>– Control sequence: Not auto c/o (P001 > 2)<br>– Fan operation: Enabled (P350 <> 0)<br> | <b>1 stage Heat and Cool with electric heater</b><br>– Control sequence: No impact (P001 <> 2)<br>– Fan operation: Disabled (P350 = 0)<br> |
| 4-pipe/2-stage                    | <b>4-pipe/2-stage fan coil unit</b><br>– Control sequence: Not auto c/o (P001 > 2)<br>– Fan operation: Enabled (P350 <> 0)<br>              | <b>4-pipe/2-stage</b><br>– Control sequence: Not auto c/o (P001 > 2)<br>– Fan operation: Disabled (P350 = 0)<br>                           |

### 5.2.3 Operation and monitoring with OZW772

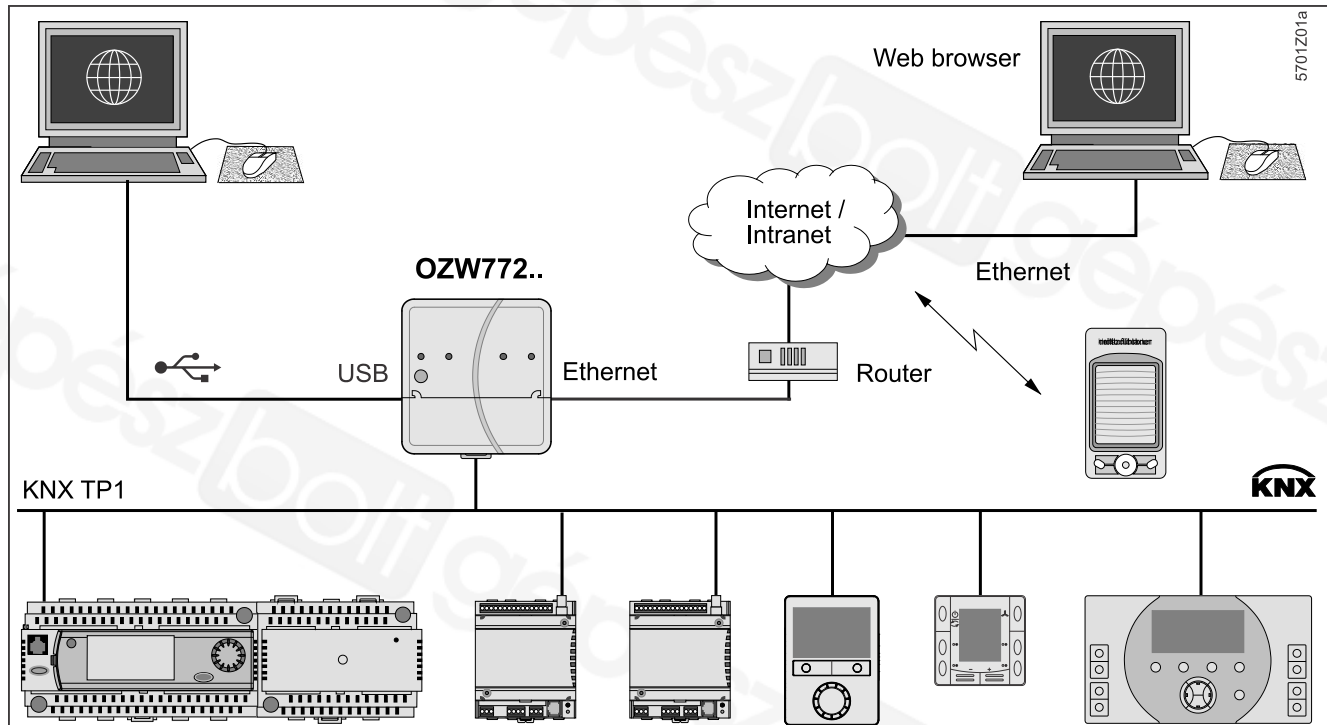

5701201a



#### HomeControl app for plant control

The OZW772 web server allows users to operate a Synco HVAC system from a remote location – via a PC or from a smart phone using the HomeControl app.

The start page displays the most important data points. A combination of menu/path navigation allows users to access all data points quickly and easily. The entire installation can be visualized in the form of plant diagrams. Alarm and state messages can be forwarded to different message recipients, such as e-mail, SMS, etc.

For details, see Commissioning Instructions [→ 6] CE1C5701 [20].

## 5.3 PCT Go – Smartphone app



The Siemens smartphone app, Product Commissioning Tool (PCT Go) is a commissioning and service tool for RDG2.. thermostats.

It supports all communicative and standalone models of the RDG200 series.

PCT Go uses NFC (Near Field Communication) to read and write data, while the device is either powered, or unpowered, even from the individual package.

Setting the devices locally is useful:

- System and system commissioning tools are not available.
- Function and wiring test is required.
- The thermostats are standalone.

To read or write settings, the smartphone must have embedded NFC and be activated, and the phone must be held close to the NFC antenna (in the thermostat) at a distance up to  $\pm 2$  cm.

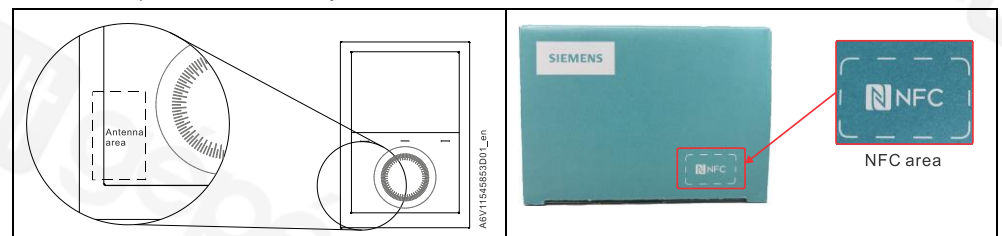

### Note

NFC function required. (for example, iPad does not support.)

PCT Go is available for smartphones (version 8 or higher) compatible with NFC. It can be downloaded from Google Play and Apple store.

Download app from App Store



Available on the  
App Store

Download app from Google Play Store



GET IT ON  
Google Play

### Commissioning RDG2.. for PXC4/5/7 integration

RDG commissioning for PXC4, 5, or 7 integrations must be done via ABT Site. PCT Go must not be used.

### Commissioning old version RDG2.. via PCT Go

When commissioning parameters on earlier versions of RDG2.. via PCT Go:

- Tap **Add parameter set**  $\Rightarrow$  **Read from device** to read configured parameters from the device
- Change the parameters as per desired
- Send the modified parameters to the device

For valid PCT Go and RDG2.. versions, see Supported tools [ $\rightarrow$  173].

### 5.3.1 Commissioning parameter via PCT Go

Selecting "Commissioning" in the menu, PCT Go can:

- Read and write thermostat parameters
- Set the application (e.g. 2-pipe)
- Change settings (e.g. setpoints)
- Set KNX addressing (device address) (RDG2..KN)
- Share commissioning data via standard communication tools, e.g., email
- Generate commissioning report

When set locally with the PCT Go app, the device can be reset using the system tools and reconfigured as needed.

DIP switch settings take priority:

- PCT Go can be used to change the application (e.g. 2-pipe) if all DIP switches are set to Off (default).
- PCT Go cannot change settings if an application is set via DIP switches.

Change settings while the device is powered and running:

- Application settings require a device reboot.
- Settings such as setpoint and HMI tuning take effect a few seconds later.

Change settings while the device is unpowered:

- Current thermostat settings can be read and written any time while unpowered
- The thermostat needs to be powered to store the new settings and ensure they are correct.

#### Notes

- Each time the application is changed, the thermostat reloads the factory setting for all control parameters, except KNX device and zone addresses.

#### Security

- Access to the thermostat settings can be password protected (P502). PCT Go requires that the password be read and write-protected. The thermostat is locked after 5 attempts for 5 minutes.
- Commissioning using PCT Go can be disabled via parameters to prevent unexpected changes of the thermostat (P500).



### 5.3.2 Read live data via PCT Go

After installation, commissioning and power-on, installers can load the working data for the thermostat to the PCT Go via NFC, by selecting "Read live data".

The information allows the installer to verify if the device operates in expected conditions and correctly wired.

The following data can be read via PCT Go:

- Data menu:
  - Sensor measurement and correction
  - Working conditions (H/C demand, H/C sequence, operating mode)
  - Application information
  - Input / output information
  - KNX related settings
- Device menu:
  - Device information

#### Example:

|                    | Measured values                                 | Data                                              | Device                        |
|--------------------|-------------------------------------------------|---------------------------------------------------|-------------------------------|
| ☰ Commissioning    | S01 : Room temperature<br>25.3 °C               | d11 : Active H/C sequence<br>1 - Heating sequence | Device<br>RDG260T             |
| 🔧 Read live data   | P06 : Measured value correction<br>0.0 K        | d12 : Current H/C demand<br>100.0 %               | Firmware version<br>04.00.11  |
| 🕒 Device time sync | S02 : Current room temp. setpoint<br>28.0 °C    | S201 : Output 1<br>45.0 %                         | Protocol version<br>4.01      |
| ⚙️ Settings        | S03 : Active room operating mode<br>0 - Comfort | S203 : Output 2<br>0.0 %                          | Serial number<br>332012250030 |
| ℹ️ Info            |                                                 |                                                   |                               |

The live data can be saved and a project report (PDF file) generated.

#### Note

For the application with 6-port PICV, live data displays the selected limitation and measurement of the waterflow in liters per hours.

## 5.4 ABT Site / ABT Go (PXC, PL-link integration)

KNX PL-Link RDG are configured by using the Desigo standard tool ABT Site and the assignment is supported by ABT Go.

Follow instructions and indications described in the Desigo documentation A6V13054432 and A6V13054435 for the integration.

See also PL-Link integration in PXC 4, 5 and 7 [→ 153].

### 5.4.1 Operation with ABT Site

For the PL-Link integration into PXC4/5/7, ABT Site needs to be used. For related commissioning workflow, see Desigo document (A6V13054435) listed in Reference documents [→ 6].

The screenshot displays the Siemens ABT Site software interface. The main window is titled "Siemens - ABT Site - 1" and shows the "Engineering" tab. The left sidebar contains navigation options: Projects, Building, Startup, Web Interface, Configuration, Engineering (selected), Reports, Advanced, and Settings. The main area is divided into several sections:

- Plants:** A tree view showing a "Plant" under "Plants".
- KNX PL-Link:** A section showing a "5mA" current setting and a "50mA" limit. It includes a "Filter" input and a list of KNX networks, including "[RDG200KN] Room thermostat, triac control outputs for C".
- Configuration:** A section showing a "Name" and "Value" table for the selected device. The table lists various parameters and their values.

| Name               | Value             |
|--------------------|-------------------|
| Filter             | Filter            |
| Power consump...   | 5 [mA]            |
| Application type   | 2-pipe / 2-stage  |
| Service paramet... |                   |
| P001: Control...   | Cooling only      |
| P002: Operati...   | Auto / Protection |
| P003: Operati...   | Auto / Manual     |
| P004: Unit         | °C                |
| P005: Schedu...    | Disable           |
| P006: Measur...    | 0 [K]             |
| P007: Humidi...    | 0 [%]             |
| P008: Default...   | Room temperature  |

At the bottom of the interface, a status bar indicates "Field device operation in progress, wait".

## 6 Connection

### 6.1 Connection terminals

| RDG20..                        |                                                                                                                                                                                                                                                                                               |
|--------------------------------|-----------------------------------------------------------------------------------------------------------------------------------------------------------------------------------------------------------------------------------------------------------------------------------------------|
| RDG20..KN (AC 230 V / AC 24 V) |                                                                                                                                                                                                                                                                                               |
|                                |                                                                                                                                                                                                                                                                                               |
| RDG20..T (AC 230 V)            |                                                                                                                                                                                                                                                                                               |
|                                |                                                                                                                                                                                                                                                                                               |
| L, N                           | Operating voltage AC 230 V / AC 24 V                                                                                                                                                                                                                                                          |
| X1, X2, X3                     | Multifunctional input for temperature sensor (NTC 3k or LG-Ni1000) or potential-free switch (function can be selected via parameter)                                                                                                                                                          |
| U1                             | Selectable input/output function: <ul style="list-style-type: none"> <li>• Multifunctional input for temperature sensor (NTC 3k or LG-Ni1000) or potential-free switch (function can be selected via parameter)</li> <li>• Multifunctional output DC 0...10 V for fresh air damper</li> </ul> |
| M                              | Measuring neutral for sensors and switches                                                                                                                                                                                                                                                    |
| CE+, CE-                       | KNX Bus + and – terminals                                                                                                                                                                                                                                                                     |
| Q1                             | Control output for fan speed I AC 230 V / AC 24 V                                                                                                                                                                                                                                             |
| Q2                             | Control output for fan speed II AC 230 V / AC 24 V                                                                                                                                                                                                                                            |
| Q3                             | Control output for fan speed III AC 230 V / AC 24 V                                                                                                                                                                                                                                           |
| Q1...Q3                        | Also for special functions AC 230 V / AC 24 V                                                                                                                                                                                                                                                 |
| Y1...Y4                        | Control outputs "Valve" AC 230 V or AC 24 V (Normally open triac, for normally closed valves), output for electric heater via external relay                                                                                                                                                  |
| Y50                            | Control output "Fan" DC 0...10 V                                                                                                                                                                                                                                                              |

| RDG26..       |                                                                                                                                                                                                                                                                                                                                                             |
|---------------|-------------------------------------------------------------------------------------------------------------------------------------------------------------------------------------------------------------------------------------------------------------------------------------------------------------------------------------------------------------|
| RDG26..KN     |                                                                                                                                                                                                                                                                                                                                                             |
|               |                                                                                                                                                                                                                                                                                                                                                             |
| RDG26..T      |                                                                                                                                                                                                                                                                                                                                                             |
|               |                                                                                                                                                                                                                                                                                                                                                             |
| G, G0         | Operating voltage AC 24 V / DC 24 V                                                                                                                                                                                                                                                                                                                         |
| L1            | Feed for relays AC 24...230 V                                                                                                                                                                                                                                                                                                                               |
| X1, X2, X3    | Multifunctional input for temperature sensor (NTC 3k or LG-Ni1000) or potential-free switch (function can be selected via parameter)                                                                                                                                                                                                                        |
| U1            | Selectable input/output function: <ul style="list-style-type: none"> <li>• Multifunctional input for temperature sensor (NTC 3k or LG-Ni1000) or potential-free switch (function can be selected via parameter)</li> <li>• Multifunctional output DC 0...10 V for fresh air damper or 2<sup>nd</sup> stage cooling in 4-pipe/2-stage application</li> </ul> |
| M             | Measuring neutral for sensors and switches                                                                                                                                                                                                                                                                                                                  |
| CE+, CE-      | KNX bus + and – terminals                                                                                                                                                                                                                                                                                                                                   |
| Q1 (L1)       | Control output for fan speed I AC 230 V / AC 24 V                                                                                                                                                                                                                                                                                                           |
| Q2 (L1)       | Control output for fan speed II AC 230 V / AC 24 V                                                                                                                                                                                                                                                                                                          |
| Q3 (L1)       | Control output for fan speed III AC 230 V / AC 24 V                                                                                                                                                                                                                                                                                                         |
| Q1...Q3 (L1)  | For special functions AC 24...230 V                                                                                                                                                                                                                                                                                                                         |
| Y10, Y20, Y30 | Control outputs "Valve" DC 0...10 V                                                                                                                                                                                                                                                                                                                         |
| Y50           | Control output "Fan" DC 0...10 V                                                                                                                                                                                                                                                                                                                            |

## 6.2 Connection diagrams

Connection workflow:

- Select fan control type: DC, 1-speed or 3-speed fan
- Select application type, e.g. 4-pipe
- Columns V1, V2, V3, V4 show the output types (e.g. for 4-pipe: YH for heating and YC for cooling) as well the available control signals
- Select the requested control output signals (e.g. 2-pos for heating, 2-pos for cooling)
- Equipment V1, V2 etc. stands for the connected equipment on each terminal, e.g. 4-pipe with outputs of 2-pos and 2-pos, V1 (valve actuator) connects to Y1 and V2 (valve actuator) to Y2

### Notes

- "2-pos" can be used for control signal On/Off and PWM
- For universal applications, fan function needs to be switched off via P350

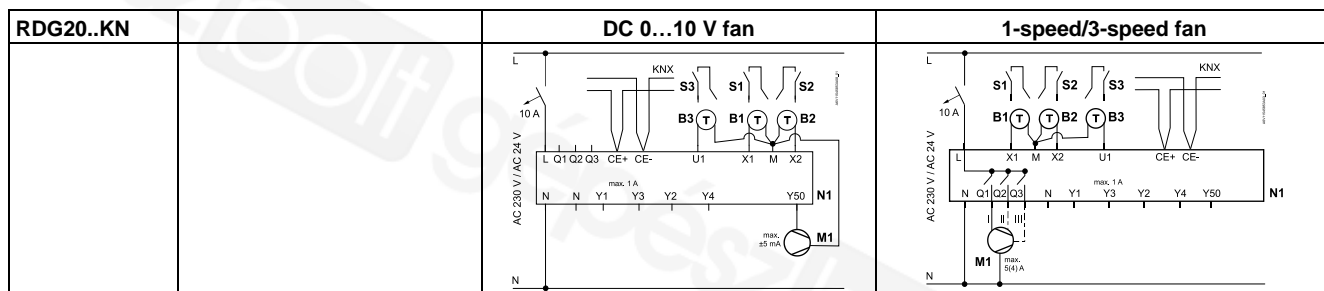

| Application      | Equipment | Terminals |  |  |        | Terminals |  |  |     |            |        |    |  |  |
|------------------|-----------|-----------|--|--|--------|-----------|--|--|-----|------------|--------|----|--|--|
|                  | V1        |           |  |  | Y1     | Y3        |  |  | Y50 | Q1, Q2, Q3 | Y1     | Y3 |  |  |
| 2-pipe           | YHC       |           |  |  |        |           |  |  |     |            |        |    |  |  |
| Control outputs: | 2-pos     |           |  |  | V1     |           |  |  | ✓   | ✓          | V1     |    |  |  |
|                  | 3-pos     |           |  |  | ▲ V1 ▼ |           |  |  |     |            | ▲ V1 ▼ |    |  |  |

| Application      | Equipment |       | Terminals |  |  |  | Terminals |    |        |    |     |            |        |    |        |    |
|------------------|-----------|-------|-----------|--|--|--|-----------|----|--------|----|-----|------------|--------|----|--------|----|
|                  | V1        | V2    |           |  |  |  | Y1        | Y3 | Y2     | Y4 | Y50 | Q1, Q2, Q3 | Y1     | Y3 | Y2     | Y4 |
| 2-pipe + RAD     | YHC       | YR    |           |  |  |  |           |    |        |    |     |            |        |    |        |    |
| 4-pipe           | YH        | YC    |           |  |  |  |           |    |        |    | ✓   | ✓          |        |    |        |    |
| 2-pipe/2-stage   | YHC1      | YHC2  |           |  |  |  |           |    |        |    |     |            |        |    |        |    |
| Control outputs: | 2-pos     | 2-pos |           |  |  |  | V1        |    | V2     |    |     |            | V1     |    | V2     |    |
|                  | 2-pos     | 3-pos |           |  |  |  | V1        |    | ▲ V2 ▼ |    |     |            | V1     |    | ▲ V2 ▼ |    |
|                  | 3-pos     | 2-pos |           |  |  |  | ▲ V1 ▼    |    | V2     |    |     |            | ▲ V1 ▼ |    | V2     |    |
|                  | 3-pos     | 3-pos |           |  |  |  | ▲ V1 ▼    |    | ▲ V2 ▼ |    |     |            | ▲ V1 ▼ |    | ▲ V2 ▼ |    |

| Application                 | Equipment |       | Terminals |  |  |  | Terminals |    |        |    |     |            |        |    |        |    |
|-----------------------------|-----------|-------|-----------|--|--|--|-----------|----|--------|----|-----|------------|--------|----|--------|----|
|                             | V1        | V2    |           |  |  |  | Y1        | Y3 | Y2     | Y4 | Y50 | Q1, Q2, Q3 | Y1     | Y3 | Y2     | Y4 |
| 2-pipe with electric heater | YHC       | YE    |           |  |  |  |           |    |        |    |     |            |        |    |        |    |
| Control outputs:            | 2-pos     | 2-pos |           |  |  |  | V1        |    | V2     |    |     |            | V1     |    | V2     |    |
|                             | 2-pos     | 3-pos |           |  |  |  | V1        |    | ▲ V2 ▼ |    |     |            | V1     |    | ▲ V2 ▼ |    |
|                             | 3-pos     | 2-pos |           |  |  |  | ▲ V1 ▼    |    | V2     |    |     |            | ▲ V1 ▼ |    | V2     |    |
|                             | 3-pos     | 3-pos |           |  |  |  | ▲ V1 ▼    |    | ▲ V2 ▼ |    |     |            | ▲ V1 ▼ |    | ▲ V2 ▼ |    |

| Application                 | Equipment |       |       | Terminals |  |  |  | Terminals |        |    |    |     |            |    |        |    |    |
|-----------------------------|-----------|-------|-------|-----------|--|--|--|-----------|--------|----|----|-----|------------|----|--------|----|----|
|                             | V1        | V2    | V3    |           |  |  |  | Y1        | Y2     | Y4 | Y3 | Y50 | Q1, Q2, Q3 | Y1 | Y2     | Y4 | Y3 |
| 4-pipe with electric heater | YH        | YC    | YE    |           |  |  |  |           |        |    |    |     |            |    |        |    |    |
| Control outputs:            | 2-pos     | 2-pos | 2-pos |           |  |  |  | V1        | V2     |    | V3 |     |            | V1 | V2     |    | V3 |
|                             | 2-pos     | 3-pos | 2-pos |           |  |  |  | V1        | ▲ V2 ▼ |    | V3 |     |            | V1 | ▲ V2 ▼ |    | V3 |

| Application                | Equipment |       |       |       | Terminals |    |    |    | Terminals |            |    |    |    |    |
|----------------------------|-----------|-------|-------|-------|-----------|----|----|----|-----------|------------|----|----|----|----|
|                            | V1        | V2    | V3    | V4    | Y1        | Y2 | Y3 | Y4 | Y50       | Q1, Q2, Q3 | Y1 | Y2 | Y3 | Y4 |
| 4-pipe/2-stage (RDG20..KN) | YH1       | YC1   | YH2   | YC2   |           |    |    |    |           |            |    |    |    |    |
| Control outputs:           | 2-pos     | 2-pos | 2-pos | 2-pos | V1        | V2 | V3 | V4 | ✓         | ✓          | V1 | V2 | V3 | V4 |

N1 Room thermostat RDG20..

S1, S2, S3 Switch (keycard, window contact, presence detector etc.)

V1, V2, V3, V4 Valve actuators:  
On/Off or PWM, 3-position, heating, cooling, radiator, heating/cooling, 1<sup>st</sup> or 2<sup>nd</sup> stage

YE Electric heater

K Relay

CE+ KNX data +

CE- KNX data -

M1

B1, B2, B3

YH

YH

YH

YH

YH

YH

YH

YH

YH

YH

1-speed or 3-speed fan, DC 0...10 V fan

Temperature sensor (return air temperature, external room temperature, changeover sensor, etc.)

Heating valve actuator

Heating valve actuator

Heating valve actuator

Cooling valve actuator

Heating/cooling valve actuator

Radiator valve actuator

1<sup>st</sup>/2<sup>nd</sup> stage

1<sup>st</sup>/2<sup>nd</sup> stage

1<sup>st</sup>/2<sup>nd</sup> stage

Note: Use X3 instead if there is no KNX.

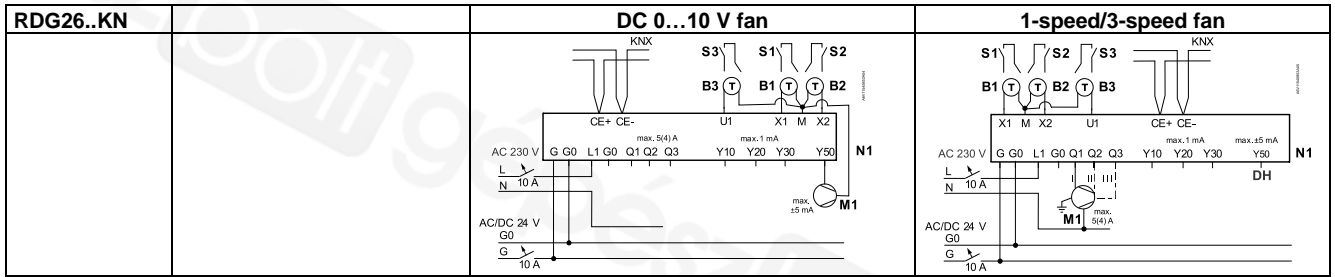

| Application      | Equipment | Terminals |     |     |            | Terminals |  |  |  |
|------------------|-----------|-----------|-----|-----|------------|-----------|--|--|--|
|                  | V1        | Q1        | Y10 | Y50 | Q1, Q2, Q3 | Y10       |  |  |  |
| 2-pipe           | YHC       |           |     |     |            |           |  |  |  |
| Control outputs: | DC        |           | V1  |     |            | V1        |  |  |  |
|                  | On/Off    | V1        |     | ✓   | ✓          |           |  |  |  |

| Application      | Equipment |        | Terminals |    |     |     | Terminals |            |     |     |
|------------------|-----------|--------|-----------|----|-----|-----|-----------|------------|-----|-----|
|                  | V1        | V2     | Q1        | Q2 | Y10 | Y20 | Y50       | Q1, Q2, Q3 | Y10 | Y20 |
| 2-pipe + RAD     | YHC       | YR     |           |    |     |     |           |            |     |     |
| 4-pipe           | YH        | YC     |           |    |     |     |           |            |     |     |
| 2-pipe/2-stage   | YHC1      | YHC2   |           |    |     |     |           |            |     |     |
| Control outputs: | DC        | DC     |           |    | V1  | V2  |           |            | V1  | V2  |
|                  | DC        | On/Off |           | V2 | V1  |     | ✓         | ✓          |     |     |
|                  | On/Off    | DC     | V1        |    |     | V2  |           |            |     |     |
|                  | On/Off    | On/Off | V1        | V2 |     |     |           |            |     |     |

| Application                 | Equipment |        | Terminals |    |     |     | Terminals |            |     |     |
|-----------------------------|-----------|--------|-----------|----|-----|-----|-----------|------------|-----|-----|
|                             | V1        | V2     | Q1        | Q2 | Y10 | Y20 | Y50       | Q1, Q2, Q3 | Y10 | Y20 |
| 2-pipe with electric heater | YHC       | YE     |           |    |     |     |           |            |     |     |
| Control outputs:            | DC        | DC     |           |    | V1  | V2  |           |            | V1  | V2  |
|                             | DC        | On/Off |           | V2 | V1  |     | ✓         | ✓          |     |     |
|                             | On/Off    | DC     | V1        |    |     | V2  |           |            |     |     |
|                             | On/Off    | On/Off | V1        | V2 |     |     |           |            |     |     |

| Application                 | Equipment |    |        | Terminals |     |     |     |     | Terminals  |     |     |     |
|-----------------------------|-----------|----|--------|-----------|-----|-----|-----|-----|------------|-----|-----|-----|
|                             | V1        | V2 | V3     | Q2        | Y10 | Y20 | Y30 | Y50 | Q1, Q2, Q3 | Y10 | Y20 | Y30 |
| 4-pipe with electric heater | YH        | YC | YE     |           |     |     |     |     |            |     |     |     |
| Control outputs:            | DC        | DC | DC     |           | V1  | V2  | V3  |     |            | V1  | V2  | V3  |
|                             | DC        | DC | On/Off |           | V3  | V1  | V2  | ✓   | ✓          |     |     |     |

| Application                | Equipment |     |     |     | Terminals |     |     |     |     | Terminals  |     |     |     |    |
|----------------------------|-----------|-----|-----|-----|-----------|-----|-----|-----|-----|------------|-----|-----|-----|----|
|                            | V1        | V2  | V3  | V4  | U1        | Y10 | Y20 | Y30 | Y50 | Q1, Q2, Q3 | Y10 | Y20 | Y30 | U1 |
| 4-pipe/2-stage (RDG26..KN) | YH1       | YC1 | YH2 | YC2 |           |     |     |     |     |            |     |     |     |    |
| Control outputs:           | DC        | DC  | DC  | DC  | V4        | V1  | V2  | V3  | ✓   | ✓          | V1  | V2  | V3  | V4 |

- |            |                                                          |                               |                                                                                                                                   |
|------------|----------------------------------------------------------|-------------------------------|-----------------------------------------------------------------------------------------------------------------------------------|
| N1         | Room thermostat RDG26..                                  | M1                            | 1-speed or 3-speed fan, DC 0...10 V fan                                                                                           |
| S1, S2, S3 | Switch (keycard, window contact, presence detector etc.) | V1, V2, V3, V4                | Valves actuators:<br>On/Off or DC 0...10 V, heating, cooling, radiator, heating/cooling, 1 <sup>st</sup> or 2 <sup>nd</sup> stage |
| YE         | Electric heater                                          | B1, B2, B3                    | Temperature sensor (return air temperature, external room temperature, changeover sensor, etc.)                                   |
| YH         | Heating valve actuator                                   | YHC                           | Heating/cooling valve actuator                                                                                                    |
| YC         | Cooling valve actuator                                   | YR                            | Radiator valve actuator                                                                                                           |
| CE+        | KNX data +                                               | YHC1/YH1/YH2/<br>YHC2/YC1/YC2 | 1 <sup>st</sup> /2 <sup>nd</sup> stage                                                                                            |
| CE-        | KNX data -                                               |                               |                                                                                                                                   |

Note: Use X3 instead if there is no KNX.

|                     |                                                             |
|---------------------|-------------------------------------------------------------|
| <b>RDG26..KN</b>    |                                                             |
| <b>Application</b>  | <b>4-pipe with 6-port PICV</b>                              |
| DC 0...10 V fan     |                                                             |
| 1-speed/3-speed fan |                                                             |
| <b>Application</b>  | <b>4-pipe with 6-port ball valve as changeover and PICV</b> |
|                     |                                                             |

|            |                                                                                                 |     |                                         |
|------------|-------------------------------------------------------------------------------------------------|-----|-----------------------------------------|
| N2         | Room thermostat RDG26..KN                                                                       | V3  | 6-port modulating control actuator      |
| S1, S2, S3 | Switch (keycard, window contact, presence detector etc.)                                        | V4  | PICV control valve                      |
| B1, B2, B3 | Temperature sensor (return air temperature, external room temperature, changeover sensor, etc.) | M1  | 1-speed or 3-speed fan, DC 0...10 V fan |
| CE-        | KNX data -                                                                                      | CE+ | KNX data +                              |

**Note:**

- In application "4-pipe with 6-port ball valve as changeover and PICV", Y50 can be connected with a DC 0...10 V fan.
- Use X3 instead if there is no KNX.



### 6.3 IAQ - CO2 connection diagrams (RDG2..KN)

For all applications and equipment combination supporting the IAQ -CO<sub>2</sub> function (see IAQ - CO2 monitoring and control (RDG2..KN) [→ 75]), the fresh air damper (DC or On/Off) can be controlled via KNX S-Mode objects or directly connected to the thermostat as follows:

- DC damper is connected to terminal U1
- ON/Off damper is connected to terminal Q3 (relay output).  
Exception:  
RDG204KN, for applications with 3-speed fan control: terminal Y4 (triac output)

### 6.4 Application examples

The examples are described for RDG26..KN, but they also apply to RDG20..KN. Control output (P201, P204) and terminals for the valves (Y1, Y2) need to be adapted accordingly.

#### 6.4.1 Humidity control

**Note:**

In the following examples, P461 is configured based on the connected type of equipment. See details in Humidity (RDG2..KN) [→ 65].

**Example 1:  
Dehumidifier,  
DC 0...10 V fan and valve**

2-pipe fan coil application for dehumidification, with temperature setpoint shifting and dehumidifier contact, DC 0...10 V fan and DC valve:

| Commissioning                                                                                                                                                                                                                                                                                                | Outputs used                                                                                                                                         |
|--------------------------------------------------------------------------------------------------------------------------------------------------------------------------------------------------------------------------------------------------------------------------------------------------------------|------------------------------------------------------------------------------------------------------------------------------------------------------|
| <ul style="list-style-type: none"> <li>• Fan P351 = 3 (or DIP6 = OFF)</li> <li>• Control strategy P450 = 1</li> <li>• Setpoint high P024 = 50 % (factory setting)</li> <li>• Temp. shift P461 = 3 K (factory setting)</li> <li>• Valve P201 = 5</li> <li>• Relay function P402 = 7 (dehumidifier)</li> </ul> | <ul style="list-style-type: none"> <li>• M1 DC 0...10 V fan</li> <li>• V1 DC valve</li> <li>• L3*) Dehumidifier</li> </ul> <p>*) Release contact</p> |
| <p>⚠ See Technical data [→ 207] for min. and max. ratings</p>                                                                                                                                                                                                                                                |                                                                                                                                                      |
| RDG26..KN                                                                                                                                                                                                                                                                                                    |                                                                                                                                                      |

**Example 2:**  
Dehumidifier,  
DC 0...10 V fan + valve,  
No shifting setpoint

2-pipe fan coil application for dehumidification, with DC 0...10 V fan and DC valve (without temperature setpoint shifting):

| Commissioning                                                                                                                                                                                                                                                                | Outputs used                                                                                                                                   |
|------------------------------------------------------------------------------------------------------------------------------------------------------------------------------------------------------------------------------------------------------------------------------|------------------------------------------------------------------------------------------------------------------------------------------------|
| <ul style="list-style-type: none"> <li>Fan P351 = 3 (or DIP6 = OFF)</li> <li>Control strategy P450 = 1</li> <li>Setpoint high P024 = 50 % (factory setting)</li> <li>Temp. shift P461 = 0</li> <li>Valve P201 = 5</li> <li>Relay function P402 = 7 (dehumidifier)</li> </ul> | <ul style="list-style-type: none"> <li>M1 DC 0...10 V fan</li> <li>V1 DC valve</li> <li>L3*) Dehumidifier</li> </ul> <p>*) Release contact</p> |
| <p>See Technical data [→ 207] for min. and max. ratings</p>                                                                                                                                                                                                                  | RDG26..KN                                                                                                                                      |

**Example 3:**  
Dehum./DC 0...10 V fan,  
On/Off valves

4-pipe fan coil application for dehumidification, with temperature setpoint shifting, dehumidifier contact, DC 0...10 V fan and On/Off valves:

| Commissioning                                                                                                                                                                                                                                                                                         | Outputs used                                                                                                                                            |
|-------------------------------------------------------------------------------------------------------------------------------------------------------------------------------------------------------------------------------------------------------------------------------------------------------|---------------------------------------------------------------------------------------------------------------------------------------------------------|
| <ul style="list-style-type: none"> <li>Fan P351 = 3 (or DIP6 = OFF)</li> <li>Control strategy P450 = 1</li> <li>Setpoint high P024 = 50 % (factory setting)</li> <li>Temp. shift P461 = 3 K (factory setting)</li> <li>Valve P201/P203 = 4</li> <li>Relay function P402 = 7 (dehumidifier)</li> </ul> | <ul style="list-style-type: none"> <li>M1 DC 0...10 V fan</li> <li>V1, V2 On/Off valves</li> <li>L3*) Dehumidifier</li> </ul> <p>*) Release contact</p> |
| <p>See Technical data [→ 207] for min. and max. ratings</p>                                                                                                                                                                                                                                           | RDG26..KN                                                                                                                                               |

**Example 4:**  
**Dehumidifier +**  
**humidifier/DC 0...10 V**  
**fan**

2-pipe fan coil application for dehumidification, with temperature setpoint shifting, dehumidifier contact, DC 0...10 V fan and DC valve, humidification is controlled by release contact:

| Commissioning                                                                                                                                                                                                                                                                                                                                                                  |                                                                                                                                                                                                          | Outputs used |
|--------------------------------------------------------------------------------------------------------------------------------------------------------------------------------------------------------------------------------------------------------------------------------------------------------------------------------------------------------------------------------|----------------------------------------------------------------------------------------------------------------------------------------------------------------------------------------------------------|--------------|
| <ul style="list-style-type: none"> <li>Fan P351 = 3 (or DIP6 = OFF)</li> <li>Control strategy P450 = 1</li> <li>Setpoint high P024 = 50 % (factory setting)</li> <li>Setpoint low P026 = 30 %</li> <li>Temp. shift P461 = 3 K (factory setting)</li> <li>Valve P201 = 5</li> <li>Relay function P402 = 7 (Q3) (dehum.)</li> <li>Relay function P401 = 8 (Q2) (hum.)</li> </ul> | <ul style="list-style-type: none"> <li>M1 DC 0...10 V fan</li> <li>V1 DC valve</li> <li>L2<sup>*)</sup> Humidifier</li> <li>L3<sup>*)</sup> Dehumidifier</li> </ul> <p><sup>*)</sup> Release contact</p> |              |
| <p>See Technical data [→ 207] for min. and max. ratings</p>                                                                                                                                                                                                                                                                                                                    |                                                                                                                                                                                                          | RDG26..KN    |

**Example 5:**  
**Dehum./3-speed fan**

2-pipe fan coil application for dehumidification, with temperature setpoint shifting, dehumidifier contact (via external converter) and 3-speed fan:

| Commissioning                                                                                                                                                                                                                                   |                                                                                                                                                                                                    | Outputs used |
|-------------------------------------------------------------------------------------------------------------------------------------------------------------------------------------------------------------------------------------------------|----------------------------------------------------------------------------------------------------------------------------------------------------------------------------------------------------|--------------|
| <ul style="list-style-type: none"> <li>Fan P351 = 2 (or DIP6 = ON)</li> <li>Control strategy P450 = 1</li> <li>Setpoint high P024 = 50 % (factory setting)</li> <li>Temp. shift P461 = 3 K (factory setting)</li> <li>Valve P201 = 5</li> </ul> | <ul style="list-style-type: none"> <li>M1 3-speed fan</li> <li>V1 DC valve</li> <li>C1 DC - On/Off converter</li> <li>L3<sup>*)</sup> Dehumidifier</li> </ul> <p><sup>*)</sup> Release contact</p> |              |
| <p>See Technical data [→ 207] for min. and max. ratings</p>                                                                                                                                                                                     |                                                                                                                                                                                                    | RDG26..KN    |

## 6.4.2 Relay functions

### Example 1: Switching off the fan coil unit

2-pipe fan coil application, fan coil unit off during Protection mode.

| Commissioning                                                                                                                                                   | Outputs used                                                                                                                                                 |
|-----------------------------------------------------------------------------------------------------------------------------------------------------------------|--------------------------------------------------------------------------------------------------------------------------------------------------------------|
| <ul style="list-style-type: none"> <li>• Fan P351 = 3 (or DIP6 = OFF)</li> <li>• Valve P201 = 5</li> <li>• Relay function P402 = 1 (Protection mode)</li> </ul> | <ul style="list-style-type: none"> <li>• M1 DC 0...10 V fan</li> <li>• V1 DC valve</li> <li>• L3*) Fan coil</li> <li>• K Relay</li> </ul> *) Release contact |
| <p>See Technical data [→ 207] for min. and max. ratings</p>                                                                                                     | RDG26..KN                                                                                                                                                    |

### Example 2: Switching on pumps

4-pipe fan coil application, pumps on during heating and cooling demand.

| Commissioning                                                                                                                                                                                                       | Outputs used                                                                                                                                                                                      |
|---------------------------------------------------------------------------------------------------------------------------------------------------------------------------------------------------------------------|---------------------------------------------------------------------------------------------------------------------------------------------------------------------------------------------------|
| <ul style="list-style-type: none"> <li>• Fan P351 = 3 (or DIP6 = OFF)</li> <li>• Valve P201/P203 = 5</li> <li>• Relay function P401 = 3 (heating pump)</li> <li>• Relay function P402 = 4 (cooling pump)</li> </ul> | <ul style="list-style-type: none"> <li>• M1 DC 0...10 V fan</li> <li>• V1, V2 DC valve</li> <li>• L2*) Heating pump</li> <li>• L3*) Cooling pump</li> <li>• K Relay</li> </ul> *) Release contact |
| <p>See Technical data [→ 207] for min. and max. ratings</p>                                                                                                                                                         | RDG26..KN                                                                                                                                                                                         |

**Example 3:  
Compressor and  
reversing valve**

Compressor application, with reversing valve (heating/cooling) and DC 0...10 V fan fan:

| Commissioning                                                                                                                                                                                                                                                                                                                                                                                        | Outputs used                                                                                                                                                                                                    |
|------------------------------------------------------------------------------------------------------------------------------------------------------------------------------------------------------------------------------------------------------------------------------------------------------------------------------------------------------------------------------------------------------|-----------------------------------------------------------------------------------------------------------------------------------------------------------------------------------------------------------------|
| <ul style="list-style-type: none"> <li>• Application 4-pipe</li> <li>• Control output P201 = 4 (On/Off)</li> <li>• Fan P351 = 3 (or DIP6 = OFF)</li> <li>• Relay function Heating/cooling                             <ul style="list-style-type: none"> <li>– ON in demand: P401 = 2</li> <li>– Energized mode: Heating P401 = 5</li> <li>– Energized mode: Cooling P401 = 6</li> </ul> </li> </ul> | <ul style="list-style-type: none"> <li>• M1 DC 0...10 V fan</li> <li>• V1<sup>*)</sup> Reversing valve</li> <li>• V2<sup>*)</sup> Compressor</li> <li>• K Relay</li> </ul> <p><sup>*)</sup> Release contact</p> |
| <p>The diagram shows a terminal block with terminals CE+, CE-, U1, X1, M, X2, G, G0, L1, Q1, Q2, Q3, Y10, Y20, Y30, Y50. It includes connections for AC 230V (L, N, G), AC/DC 24V (G0, G), and components K, V1, V2, and M1. A note indicates 'max. ± 1 mA' for the control lines and 'See Technical data [-&gt; 207] for min. and max. ratings'.</p>                                                | <p>RDG26..KN</p>                                                                                                                                                                                                |

### 6.4.3 Swap function and/or fan in the 2nd stage

#### Example 1: Fan in the 2<sup>nd</sup> stage

2-pipe fan coil application for floor heating/cooling (2-stage heating/cooling), fan runs only in the 2<sup>nd</sup> stage:

| Commissioning                                                                                                                                                                                                                                                                                             | Outputs used                                                                                                                                                                                                                                                                                              |
|-----------------------------------------------------------------------------------------------------------------------------------------------------------------------------------------------------------------------------------------------------------------------------------------------------------|-----------------------------------------------------------------------------------------------------------------------------------------------------------------------------------------------------------------------------------------------------------------------------------------------------------|
| <ul style="list-style-type: none"> <li>Fan P350 = 4 (2<sup>nd</sup> stage)</li> <li>Valve P201 = 5 (floor)</li> <li>Valve P203 = 5 (fan coil unit)</li> </ul>                                                                                                                                             | <ul style="list-style-type: none"> <li>M1 DC 0...10 V fan</li> <li>V1 DC valve floor</li> <li>V2 DC valve fan coil units</li> </ul>                                                                                                                                                                       |
| <p>The top graph shows the fan output (Y) as a function of room temperature (TR [°C]). The fan is 100% on for heating (W) and 0% for cooling (W). The bottom graph shows the fan output (Fan) as a function of room temperature (TR [°C]). The fan is 100% on for heating (W) and 0% for cooling (W).</p> | <p>The top graph shows the fan output (Y) as a function of room temperature (TR [°C]). The fan is 100% on for heating (W) and 0% for cooling (W). The bottom graph shows the fan output (Fan) as a function of room temperature (TR [°C]). The fan is 100% on for heating (W) and 0% for cooling (W).</p> |
| <p>See Technical data [→ 207] for min. and max. ratings</p>                                                                                                                                                                                                                                               | RDG26..KN                                                                                                                                                                                                                                                                                                 |

**Example 2:  
Swap and fan in the 2<sup>nd</sup>  
stage**

2-pipe and 2-stage application with radiant heating/cooling panels, the fan only operates with the fan coil unit:

- Heating sequence: 1<sup>st</sup> panel and 2<sup>nd</sup> fan coil unit
- Cooling sequence: 1<sup>st</sup> fan coil unit and 2<sup>nd</sup> panel

| Commissioning                                                                                                                                                                                                    | Outputs used                                                                                                                                                    |
|------------------------------------------------------------------------------------------------------------------------------------------------------------------------------------------------------------------|-----------------------------------------------------------------------------------------------------------------------------------------------------------------|
| <ul style="list-style-type: none"> <li>• Fan P350 = 6 (Cooling and 2<sup>nd</sup> stage heating)</li> <li>• Valve P201 = 5 (panel)</li> <li>• Valve P203 = 5 (fan coil unit)</li> <li>• Swap P254 = 1</li> </ul> | <ul style="list-style-type: none"> <li>• M1 DC 0...10 V fan (2<sup>nd</sup> stage)</li> <li>• V1 DC valve panel</li> <li>• V2 DC valve fan coil unit</li> </ul> |
|                                                                                                                                                                                                                  |                                                                                                                                                                 |
| <p>⚠ See Technical data [→ 207] for min. and max. ratings</p>                                                                                                                                                    | <p>RDG26..KN</p>                                                                                                                                                |

### Example 3: Swap and fan in the 2<sup>nd</sup> stage

2-pipe fan coil and 2-stage application with different types of equipment (On/Off control outputs), the fan only operates if output V1 is energized.

| Commissioning                                                                                                                                                                         | Outputs used                                                                                                                                                              |
|---------------------------------------------------------------------------------------------------------------------------------------------------------------------------------------|---------------------------------------------------------------------------------------------------------------------------------------------------------------------------|
| <ul style="list-style-type: none"> <li>Fan P350 = 5 (Heating and 2<sup>nd</sup> stage cooling)</li> <li>Valve P201 = 2 (equipment 1)</li> <li>Valve P203 = 2 (equipment 2)</li> </ul> | <ul style="list-style-type: none"> <li>M1 DC 0...10 V fan (2<sup>nd</sup> stage)</li> <li>V1 On/Off valve (equipment 1)</li> <li>V2 On/Off valve (equipment 2)</li> </ul> |
| <p>3191D94</p>                                                                                                                                                                        | <p>3191D95</p>                                                                                                                                                            |
| <p>ABV11545892A10</p> <p>max. ± 1 mA</p> <p>⚠ See Technical data [→ 207] for min. and max. ratings</p>                                                                                | RDG26..KN                                                                                                                                                                 |



### 6.4.4 IAQ -CO<sub>2</sub> control (RDG2..KN)

**Example 1:  
IAQ monitoring**

4-pipe heating and cooling fan coil system, for DC valves and fan, with IAQ indication (text) on the display:

| Commissioning                                                                                                                                                                                                                                                   | Outputs used                                                                                                   |
|-----------------------------------------------------------------------------------------------------------------------------------------------------------------------------------------------------------------------------------------------------------------|----------------------------------------------------------------------------------------------------------------|
| <ul style="list-style-type: none"> <li>Application 4-pipe</li> <li>Fan P351 = 3 (DC 0...10 V)</li> <li>Valve P201 = 5 (default)</li> <li>Valve P203 = 5 (default)</li> <li>Control strategy P450 = 0 (temp.)</li> <li>IAQ indication P009 = 7 (text)</li> </ul> | <ul style="list-style-type: none"> <li>M1 DC 0...10 V fan</li> <li>V1 DC valve</li> <li>V2 DC valve</li> </ul> |
| <p>See Technical data [→ 207] for min. and max. ratings</p>                                                                                                                                                                                                     | RDG264KN                                                                                                       |

**Example 2:  
IAQ control with DC damper**

4-pipe heating and cooling fan coil system, power supply 230 V, for PWM valves and 3-speed fan, CO<sub>2</sub> indication (ppm) on the display, IAQ control via DC damper:

| Commissioning                                                                                                                                                                                                                                                                                                                              | Outputs used                                                                                                                             |
|--------------------------------------------------------------------------------------------------------------------------------------------------------------------------------------------------------------------------------------------------------------------------------------------------------------------------------------------|------------------------------------------------------------------------------------------------------------------------------------------|
| <ul style="list-style-type: none"> <li>Application 4-pipe</li> <li>Fan P351 = 2 (3-speed)</li> <li>Valve P201 = 3 (heating)</li> <li>Valve P203 = 3 (cooling)</li> <li>Control strategy P450 = 2 (default)</li> <li>Damper signal P453 = 1 (DC)</li> <li>IAQ setpoint P023 = 1000 (def.)</li> <li>IAQ indication P009 = 6 (ppm)</li> </ul> | <ul style="list-style-type: none"> <li>M1 3-speed V fan</li> <li>V1 PWM valve H</li> <li>V2 PWM valve C</li> <li>D1 DC damper</li> </ul> |
| <p>See Technical data [→ 207] for min. and max. ratings</p>                                                                                                                                                                                                                                                                                | RDG204KN                                                                                                                                 |

**Example 3:**  
**IAQ control with On/Off damper**

4-pipe heating and cooling fan coil system, power supply 230 V, for PWM valves and DC fan, CO<sub>2</sub> indication (ppm) on the display, IAQ control via On/Off damper:

| Commissioning                                                 |                      | Outputs used       |
|---------------------------------------------------------------|----------------------|--------------------|
| • Application                                                 | 4-pipe               | • M1 DC fan        |
| • Fan                                                         | P351 = 3 (DC fan)    | • V1 PWM valve H   |
| • Valve                                                       | P201 = 3 (heating)   | • V2 PWM valve C   |
| • Valve                                                       | P203 = 3 (cooling)   | • D1 On/Off damper |
| • Control strategy                                            | P450 = 2 (default)   |                    |
| • Damper signal                                               | P453 = 3 (On/Off NC) |                    |
| • IAQ setpoint                                                | P023 = 1000 (def.)   |                    |
| • IAQ indication                                              | P009 = 6 (ppm)       |                    |
| <p>△ See Technical data [→ 207] for min. and max. ratings</p> |                      | RDG204KN           |

### 6.4.5 Ventilation air cooling (RDG2..KN)

**Example 1: fan coil - air cooling and IAQ control**

4-pipe heating and cooling fan coil system, for DC valves and fan, with IAQ control and air cooling by cooling demand:

| Commissioning                                                                                                                                                                   |                                                                                                                                                                                                                   | Outputs used                                                                                                                             |
|---------------------------------------------------------------------------------------------------------------------------------------------------------------------------------|-------------------------------------------------------------------------------------------------------------------------------------------------------------------------------------------------------------------|------------------------------------------------------------------------------------------------------------------------------------------|
| <ul style="list-style-type: none"> <li>Application</li> <li>Fan</li> <li>Valve</li> <li>Valve</li> <li>Control strategy</li> <li>Damper signal</li> <li>IAQ setpoint</li> </ul> | <ul style="list-style-type: none"> <li>4-pipe</li> <li>P351 = 2 (3-speed)</li> <li>P201 = 3 (heating)</li> <li>P203 = 3 (cooling)</li> <li>P450 = 5</li> <li>P453 = 1 (DC)</li> <li>P023 = 1000 (def.)</li> </ul> | <ul style="list-style-type: none"> <li>M1 3-speed V fan</li> <li>V1 PWM valve H</li> <li>V2 PWM valve C</li> <li>D1 DC damper</li> </ul> |
| <p>Plant diagram:</p>                                                                                                                                                           |                                                                                                                                                                                                                   | <p>Sequence</p>                                                                                                                          |
| <p>⚠ See Technical data [→ 207] for min. and max. ratings</p>                                                                                                                   |                                                                                                                                                                                                                   | <p><b>RDG204KN</b></p>                                                                                                                   |

**Example 2:**  
**Universal H/C, with air**  
**cooling in 2<sup>nd</sup> stage**  
**(“Nordic” application)**

Chilled ceiling, floor heating, fresh air control IAQ and support cooling during cooling demand

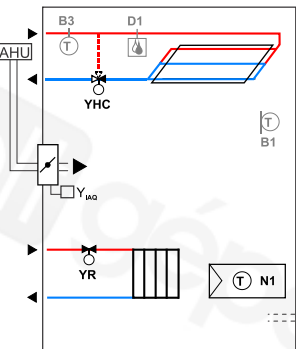
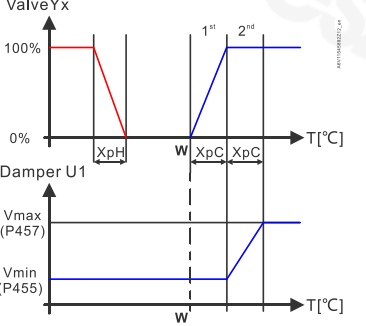
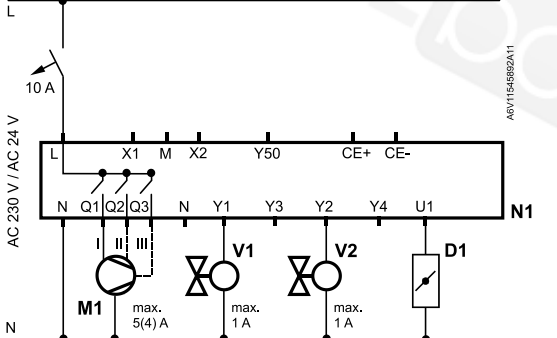
| Commissioning                                                                                                                                                                                                                                                                                           | Outputs used                                                                                                                                     |
|---------------------------------------------------------------------------------------------------------------------------------------------------------------------------------------------------------------------------------------------------------------------------------------------------------|--------------------------------------------------------------------------------------------------------------------------------------------------|
| <ul style="list-style-type: none"> <li>• Application 4-pipe</li> <li>• Fan P350 = 0 (disable)</li> <li>• Valve P201 = 3 (heating)</li> <li>• Valve P203 = 3 (cooling)</li> <li>• Control strategy P450 = 6</li> <li>• Damper signal P453 = 1 (DC)</li> <li>• IAQ setpoint P023 = 1000 (def.)</li> </ul> | <ul style="list-style-type: none"> <li>• M1 3-speed V fan</li> <li>• V1 PWM valve H</li> <li>• V2 PWM valve C</li> <li>• D1 DC damper</li> </ul> |
| <p>Plant diagram</p>                                                                                                                                                                                                  | <p>Control sequence</p>                                      |
|  <p>⚠ See Technical data [→ 207] for min. and max. ratings</p>                                                                                                                                                      | <p>RDG204KN</p>                                                                                                                                  |

**Example 3:  
Ventilation, IAQ, cooling  
with air**

Single duct air cooling and IAQ control. Reduce temperature in the room with fresh air and control CO<sub>2</sub> concentration. (RDG2..4KN with CO<sub>2</sub> sensor)

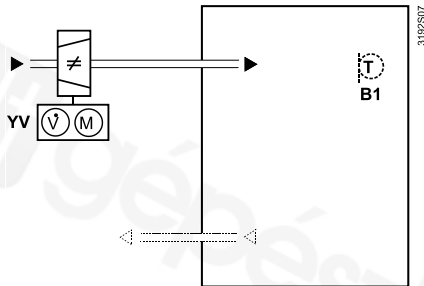
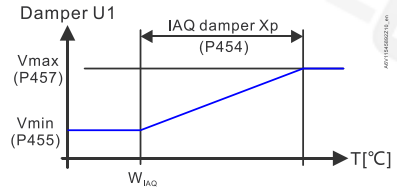
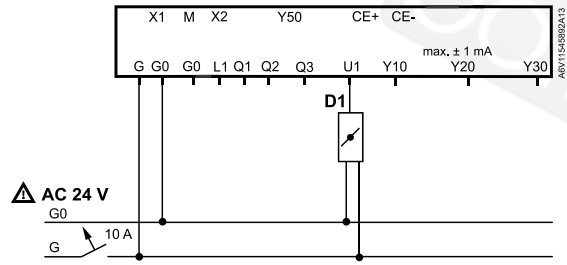
| Commissioning                                                                                                                                                                                                                                                                                                                                                                                          | Outputs used                                                                                                |
|--------------------------------------------------------------------------------------------------------------------------------------------------------------------------------------------------------------------------------------------------------------------------------------------------------------------------------------------------------------------------------------------------------|-------------------------------------------------------------------------------------------------------------|
| <ul style="list-style-type: none"> <li>• Application 2-pipe</li> <li>• Sequence P001 = 1 (cooling only)</li> <li>• IAQ SP P023 = 1000</li> <li>• P-band Cool P052 = 1</li> <li>• Fan P350 = 0 (disable)</li> <li>• Control strategy P450 = 5 (air cool.)</li> <li>• Damper signal P453 = 1 (DC)</li> <li>• IAQ Damper Xp P454 = 400</li> <li>• Vmin P455 = 30 %</li> <li>• Vmax P457 = 80 %</li> </ul> | <ul style="list-style-type: none"> <li>• D1 DC damper</li> </ul>                                            |
| <p>Plant diagram</p>                                                                                                                                                                                                                                                                                                 | <p>Control sequence</p>  |
|  <p>⚠ See Technical data [→ 207] for min. and max. ratings</p>                                                                                                                                                                                                                                                     | <p>RDG264KN</p>                                                                                             |

**Example 4:**  
Ventilation, cooling with  
air

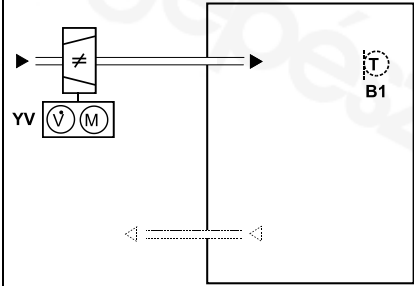
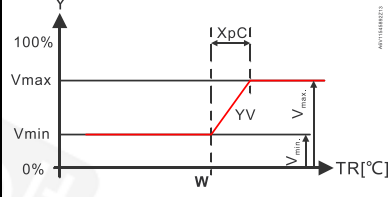
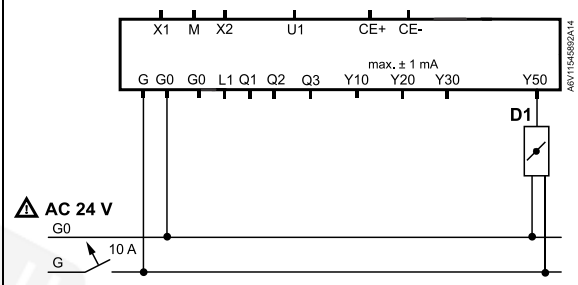

Single duct air cooling. Reduce temperature in the room with fresh air.  
(RDG260KN)

| Commissioning                                                                                                                                                                                                                                                                                                                                                                                                                                                                                                                                                                                                                                                          | Outputs used                                                                                                 |
|------------------------------------------------------------------------------------------------------------------------------------------------------------------------------------------------------------------------------------------------------------------------------------------------------------------------------------------------------------------------------------------------------------------------------------------------------------------------------------------------------------------------------------------------------------------------------------------------------------------------------------------------------------------------|--------------------------------------------------------------------------------------------------------------|
| <ul style="list-style-type: none"> <li>• Application 2-pipe</li> <li>• Sequence P001 = 1 (cooling only)</li> <li>• Fan DZ, COM P029 = 1 (Vmin)</li> <li>• P-band Cool P052 = 1</li> <li>• Fan speed P351 = 3 (DC)</li> <li>• Switching point P356 = 1</li> <li>• Vmin P357 = 30%</li> <li>• Vmax P360 = 80%</li> <li>• Fan DZ, ECO P364 = 0 (Vmin)</li> </ul> <p>Recommendations (fan functions not used):</p> <ul style="list-style-type: none"> <li>• P352 = 0 (default)</li> <li>• P365 = 0 (default)</li> </ul> <p>For correct user operation:</p> <ul style="list-style-type: none"> <li>• Fan op. selector P003 = 3</li> <li>• Keypad locked P028 = 5</li> </ul> | <ul style="list-style-type: none"> <li>• D1 DC damper</li> </ul>                                             |
| <p>Plant diagram</p>                                                                                                                                                                                                                                                                                                                                                                                                                                                                                                                                                                 | <p>Control sequence</p>  |
|  <p>AC 24 V<br/>G0 10 A</p> <p>max. ± 1 mA</p> <p>See Technical data [→ 207] for min. and max. ratings</p>                                                                                                                                                                                                                                                                                                                                                                                                                                                                         | <p>RDG260KN</p>                                                                                              |

## 7 Technical data



| Power supply (RDG20..KN)                                                                                                                                                                                                                                                                                                                                                                |                                                                     |
|-----------------------------------------------------------------------------------------------------------------------------------------------------------------------------------------------------------------------------------------------------------------------------------------------------------------------------------------------------------------------------------------|---------------------------------------------------------------------|
| Operating voltage (L-N)                                                                                                                                                                                                                                                                                                                                                                 | AC 24 V $\pm$ 20 % or<br>AC 230 V +10/-15 % (selectable via slider) |
| Frequency                                                                                                                                                                                                                                                                                                                                                                               | 50/60 Hz                                                            |
| Power consumption                                                                                                                                                                                                                                                                                                                                                                       | 4 VA @ AC 24 V, 7 VA @ AC 230 V                                     |
|  <ul style="list-style-type: none"> <li>• <b>No internal fuse!</b><br/>External preliminary protection with max. C 10 A circuit breaker required in all cases.</li> <li>• Before switching on power, select the right power supply needed using the power switch on the rear of the device.</li> </ul> |                                                                     |

| Power supply (RDG20..T)                                                                                                                                                                                                                                      |                    |
|--------------------------------------------------------------------------------------------------------------------------------------------------------------------------------------------------------------------------------------------------------------|--------------------|
| Operating voltage (L-N)                                                                                                                                                                                                                                      | AC 230 V +10/-15 % |
| Frequency                                                                                                                                                                                                                                                    | 50/60 Hz           |
| Power consumption                                                                                                                                                                                                                                            | 7 VA @ AC 230 V    |
| Power reserve clock during power failure                                                                                                                                                                                                                     | Min. 20 h          |
|  <ul style="list-style-type: none"> <li>• <b>No internal fuse!</b><br/>External preliminary protection with max. C 10 A circuit breaker required in all cases.</li> </ul> |                    |

| Outputs (RDG20..)                                                                                                                                                                                                      |                                                                               |
|------------------------------------------------------------------------------------------------------------------------------------------------------------------------------------------------------------------------|-------------------------------------------------------------------------------|
| Fan control Q1, Q2, Q3 – N                                                                                                                                                                                             | RDG20..KN: AC 24 V or AC 230 V (linked to power supply)<br>RDG20..T: AC 230 V |
| Qx rating min., max. resistive (inductive)                                                                                                                                                                             | 5 mA...5 (4) A                                                                |
|  <p><b>No internal fuse!</b><br/>External preliminary protection with max. C 10 A circuit breaker required for all cases.</p>       |                                                                               |
|  <p><b>Do not connect 3-speed fans in parallel!</b><br/>Connect one fan directly, one relay for each speed for additional fans.</p> |                                                                               |
| Use for actuator control (Q1, Q2)                                                                                                                                                                                      |                                                                               |
| <ul style="list-style-type: none"> <li>• Q1 - rating min., max. resistive/inductive</li> <li>• Q2 - rating min., max. resistive/inductive</li> </ul>                                                                   | 5 mA...1 A<br>5 mA...1 A                                                      |
| Use for external equipment (Q1, Q2, Q3)                                                                                                                                                                                |                                                                               |
| <ul style="list-style-type: none"> <li>• Rating min., max. resistive/inductive Qx</li> <li>• Max total load current Q1+Q2+Q3</li> </ul>                                                                                | 5 mA...1 A<br>2 A                                                             |
| DC 0...10 V fan control; Y50-M                                                                                                                                                                                         | SELV DC 0...10 V, max. $\pm$ 5 mA                                             |

| Outputs (RDG20..)                                                                   |                                                                                                                                               |
|-------------------------------------------------------------------------------------|-----------------------------------------------------------------------------------------------------------------------------------------------|
| Damper control (RDG204KN):<br>DC (U1)<br>On/Off (Q3/Y4)                             | SELV DC 0...10 V, $\pm 1$ mA<br>See Qx and Y4                                                                                                 |
| Control outputs<br>Y1, Y2, Y3, Y4-N<br>RDG20..KN<br>RDG20..T<br>Yx power limitation | Solid state (triacs)<br><br>AC 24 V or AC 230 V (linked to power supply)<br>AC 230 V<br>8 mA...1 A<br>3 A fast microfuse, cannot be exchanged |

| Power supply (RDG26..)                                                                                                                                                                                    |                                         |
|-----------------------------------------------------------------------------------------------------------------------------------------------------------------------------------------------------------|-----------------------------------------|
| Operating voltage (G-G0)<br>DC 24 V: Make sure to connect G to + and G0 to -                                                                                                                              | AC 24 V $\pm 20$ %<br>DC 24 V $\pm 2$ V |
| Frequency                                                                                                                                                                                                 | 50/60 Hz                                |
| Power consumption                                                                                                                                                                                         | 4 VA @ AC 24 V                          |
| Power reserve clock during power failure (RDG26..T)                                                                                                                                                       | Min. 20 h                               |
| <br><b>No internal fuse!</b><br>External preliminary protection with max. C 10 A circuit breaker required for all cases. |                                         |

| Outputs (RDG26..)                                                                                                                                                                                                           |                                               |
|-----------------------------------------------------------------------------------------------------------------------------------------------------------------------------------------------------------------------------|-----------------------------------------------|
| Fan control Q1/Q2/Q3/L-N                                                                                                                                                                                                    | AC 24...230 V / DC 24 V                       |
| Use for 3-speed fan control<br>Rating min, max resistive (inductive)                                                                                                                                                        | AC 24...230 V: 5 mA...5 (4) A<br>DC 24 V: 3 A |
| <br><b>No internal fuse!</b><br>External preliminary protection with max. C 10 A circuit breaker required for all cases.                 |                                               |
| <br><b>Do NOT connect 3-speed fans in parallel!</b><br>Connect one fan directly, for additional fans, one relay for each speed.          |                                               |
| Use for actuator control (Q1, Q2)<br><ul style="list-style-type: none"> <li>Q1 - rating min., max. resistive/inductive</li> <li>Q2 - rating min., max. resistive/inductive</li> <li>Max total load current Q1+Q2</li> </ul> | 5 mA...1 A<br>5 mA...5 (4) A<br>5 A           |
| Use for external equipment (Q1, Q2, Q3)<br><ul style="list-style-type: none"> <li>Rating min., max. resistive/inductive Qx</li> <li>Max total load current Q1+Q2+Q3</li> </ul>                                              | 5 mA...1 A<br>2 A                             |
| <br><b>No internal fuse!</b><br>External preliminary protection with max. C 10 A circuit breaker required for all cases.                 |                                               |
| DC 0...10 V fan control (Y50-M)                                                                                                                                                                                             | SELV DC 0...10 V, max. $\pm 5$ mA             |
| Actuator control (Y10-G0/Y20-G0/Y30-G0 (G))                                                                                                                                                                                 | SELV DC 0...10 V, max. $\pm 1$ mA             |



| Outputs (RDG26..)                                    |                                   |
|------------------------------------------------------|-----------------------------------|
| Damper control (RDG264KN):<br>DC (U1)<br>On/Off (Q3) | SELV DC 0...10 V, ±1 mA<br>See Qx |

| Multifunctional inputs                     |                       |
|--------------------------------------------|-----------------------|
| X1-M/X2-M/U1-M (RDG20..KN)/X3-M (RDG20..T) |                       |
| Temperature sensor input                   |                       |
| Type                                       | NTC 3k                |
| Temperature range                          | -20...70 °C           |
| Temperature sensor input                   |                       |
| Type                                       | LG-Ni1000             |
| Temperature range                          | -40...70 °C           |
| Digital input                              |                       |
| Operating action                           | Selectable (NO/NC)    |
| Contact sensing                            | DC 0...5 V, max. 5 mA |
| Insulation against mains                   | SELV                  |

| KNX bus (RDG20..KN)                                      |                                        |
|----------------------------------------------------------|----------------------------------------|
| Interface type                                           | KNX, TP Uart 2 (electrically isolated) |
| Bus current                                              | 5 mA                                   |
| Bus topology: See KNX manual ("Reference documentation") |                                        |

| Operational data                                        |             |                                                                        |
|---------------------------------------------------------|-------------|------------------------------------------------------------------------|
| Switching differential, adjustable                      |             |                                                                        |
| Heating mode                                            | (P051)      | 1 K (0.5...6 K)                                                        |
| Cooling mode                                            | (P053)      | 1 K (0.5...6 K)                                                        |
| P-band Xp                                               |             |                                                                        |
| Heating mode                                            | (P050)      | 2 K (0.5...6 K)                                                        |
| Cooling mode                                            | (P052)      | 1 K (0.5...6 K)                                                        |
| Setpoint setting and setpoint range                     |             |                                                                        |
| Comfort mode                                            | (P011)      | 21 °C (5...40 °C)                                                      |
| Economy mode                                            | (P019-P020) | 15 °C/30 °C (OFF, 5...40 °C)                                           |
| Protection mode                                         | (P100-P101) | 8 °C/OFF (OFF, 5...40 °C)                                              |
| Multifunctional inputs X1/X2/U1 (RDG2..KN)/X3 (RDG2..T) |             | RDG2..KN: Selectable (0...14)<br>RDG2..T: Selectable (0...6 & 9...14)  |
| Input X1 default value                                  | (P150)      | 1 (external temperature sensor, room or return air)                    |
| Input X2 default value                                  | (P153)      | 0 (no function)                                                        |
| Input U1 (RDG2..KN)/X3 (RDG2..T) default value          | (P155)      | RDG2..0KN & RDG2..0T: 3 (window contact)<br>RDG2..4KN: 0 (no function) |
| Built-in room temperature sensor                        |             |                                                                        |

| Operational data                               |                                                                                             |
|------------------------------------------------|---------------------------------------------------------------------------------------------|
| Measuring range                                | 0...49 °C                                                                                   |
| Accuracy at 25 °C                              | < ±0.5 K                                                                                    |
| Temperature calibration range                  | ±3 K                                                                                        |
| Built-in humidity sensor                       |                                                                                             |
| Measuring range                                | 10...90 %                                                                                   |
| Accuracy (after calibration via P007)          | < 5 %                                                                                       |
| Humidity calibration range                     | ±10 %                                                                                       |
| Built-in CO <sub>2</sub> sensor (RDG2..KN)     |                                                                                             |
| Measuring range                                | 0...5000 ppm                                                                                |
| Measuring accuracy at 25 °C and 1013 hPa       | ±(50 ppm + 4 % of measured value)                                                           |
| Temperature stability in the range of 0..50 °C | 3 ppm / °C                                                                                  |
| Long-time drift                                | 80 ppm over 5 years (typically)                                                             |
| Time constant t <sub>63</sub>                  | < 5 min                                                                                     |
| Calibration                                    | ASC<br><br>For details, see CO <sub>2</sub> (IAQ) monitoring and control (RDG2..4KN) [→ 75] |
| Settings and display resolution                |                                                                                             |
| Setpoint                                       | 0.5 °C                                                                                      |
| Present temperature value displayed            | 0.5 °C                                                                                      |

| Environmental conditions |               |
|--------------------------|---------------|
| Storage                  | IEC 60721-3-1 |
| Climatic conditions      | Class 1K3     |
| Temperature              | -25...65 °C   |
| Humidity                 | < 95 % r.h.   |
| Transport                | IEC 60721-3-2 |
| Climatic conditions      | Class 2K3     |
| Temperature              | -25...65 °C   |
| Humidity                 | < 95 % r.h.   |
| Mechanical conditions    | Class 2M2     |
| Operation                | IEC 60721-3-3 |
| Climatic conditions      | Class 3K5     |
| Temperature              | 0...50 °C     |
| Humidity                 | < 95 % r.h.   |

| Standards and directives |                                        |
|--------------------------|----------------------------------------|
| EU conformity (CE)       | A5W00120120A*                          |
| Electronic control type  | 2.B (micro-disconnection on operation) |

| Standards and directives                                                                                                                                                                                           |           |                                                                                                                                                                      |                            |             |
|--------------------------------------------------------------------------------------------------------------------------------------------------------------------------------------------------------------------|-----------|----------------------------------------------------------------------------------------------------------------------------------------------------------------------|----------------------------|-------------|
| RCM conformity                                                                                                                                                                                                     |           | A5W00120121A*                                                                                                                                                        |                            |             |
| Protection class                                                                                                                                                                                                   |           | II as per EN 60730                                                                                                                                                   |                            |             |
| Pollution class                                                                                                                                                                                                    |           | Normal                                                                                                                                                               |                            |             |
| Degree of protection of housing                                                                                                                                                                                    |           | IP30 as per EN 60529                                                                                                                                                 |                            |             |
| Eco design and labeling directives                                                                                                                                                                                 |           | Based on EU directive 813/2013 (Eco design directive) and 811/2013 (Labelling directive) concerning space heaters, combination heaters, the following classes apply: |                            |             |
| RDG20..                                                                                                                                                                                                            |           | Class I value 1 %                                                                                                                                                    |                            |             |
| <ul style="list-style-type: none"> <li>Application with On/Off operation of a heater</li> <li>PWM (TPI) room thermostat, for use with On/Off output heaters</li> </ul>                                             |           | Class IV value 2 %                                                                                                                                                   |                            |             |
| RDG26..                                                                                                                                                                                                            |           | Class I value 1 %                                                                                                                                                    |                            |             |
| <ul style="list-style-type: none"> <li>Application with On/Off operation of a heater</li> <li>PWM (TPI) room thermostat, for use with On/Off output heaters</li> </ul>                                             |           | Class IV value 2 %                                                                                                                                                   |                            |             |
| Meets the requirements for eu.bac certification (RDG2..KN) as per EN 15500-1<br>See product list at: <a href="http://www.eubacert.eu/licences-by-criteria.asp">http://www.eubacert.eu/licences-by-criteria.asp</a> |           |                                                                                                                                                                      |                            |             |
|                                                                                                                                  |           |                                                                                                                                                                      |                            |             |
| Application                                                                                                                                                                                                        | Device    | Actuator outputs                                                                                                                                                     | CA value (K)               | License No. |
| Fan coil units (2 pipes)                                                                                                                                                                                           | RDG20..KN | Thermal actuator                                                                                                                                                     | Heating 0.4<br>Cooling 0.3 | 220019      |
| Variable speed fan                                                                                                                                                                                                 | RDG26..KN | Motorized DC                                                                                                                                                         | Heating 0.1<br>Cooling 0.1 | 220020      |
| Fan coil units (2 pipes, 2 wires)                                                                                                                                                                                  | RDG20..KN | Thermal actuator                                                                                                                                                     | Heating 0.1<br>Cooling 0.3 | 220019      |
| Variable speed fan                                                                                                                                                                                                 | RDG26..KN | Motorized DC                                                                                                                                                         | Heating 0.1<br>Cooling 0.1 | 220020      |
| Fan coil units (4 pipes)                                                                                                                                                                                           | RDG20..KN | Thermal actuator                                                                                                                                                     | Heating 0.4<br>Cooling 0.3 | 220019      |
| Variable speed fan                                                                                                                                                                                                 | RDG26..KN | Motorized DC                                                                                                                                                         | Heating 0.1<br>Cooling 0.1 | 220020      |
| Ceiling systems                                                                                                                                                                                                    | RDG26..KN | Motorized DC                                                                                                                                                         | Heating 0.2<br>Cooling 0.2 | 220020      |
|                                                                                                                                                                                                                    |           | 6-port control ball valves VWG41.10...                                                                                                                               | Heating 0.2<br>Cooling 0.4 | 220020      |
|                                                                                                                                                                                                                    |           | 6-port control ball valves VWG41.20...                                                                                                                               | Heating 0.2<br>Cooling 0.4 | 220020      |

| Standards and directives                                                                                                      |                                                                                                                                                                                                                                                                                                                                                                                                                                                                                                                                |
|-------------------------------------------------------------------------------------------------------------------------------|--------------------------------------------------------------------------------------------------------------------------------------------------------------------------------------------------------------------------------------------------------------------------------------------------------------------------------------------------------------------------------------------------------------------------------------------------------------------------------------------------------------------------------|
| Environmental compatibility                                                                                                   | The product environmental declaration ( RDG200KN: A5W00085404A*, RDG260KN: A5W00116569A*, RDG200KN/BK: A5W00242785A*, RDG260KN/BK: A5W00242797A*, RDG204KN: A5W00242787A*, RDG264KN: A5W00242790A*, RDG200T: A5W00304666A*, RDG260T: A5W00304667A*) contains data on environmentally compatible product design and assessments (RoHS compliance, materials composition, packaging, environmental benefit, disposal).                                                                                                           |
| General                                                                                                                       |                                                                                                                                                                                                                                                                                                                                                                                                                                                                                                                                |
| Connection terminals                                                                                                          | Solid wires or stranded wires with wire-end sleeves<br>1 x 0.4...2.5 mm <sup>2</sup> or 2 x 0.4...1.5 mm <sup>2</sup>                                                                                                                                                                                                                                                                                                                                                                                                          |
| Minimal wiring cross section on L, N, Q1, Q2, Q3, Y1, Y2, Y3, Y4                                                              | Min. 1.5 mm <sup>2</sup>                                                                                                                                                                                                                                                                                                                                                                                                                                                                                                       |
| Maximal wiring cross section on L, N, Q1, Q2, Q3, Y1, Y2, Y3, Y4                                                              | Max. 2.5 mm <sup>2</sup>                                                                                                                                                                                                                                                                                                                                                                                                                                                                                                       |
| Housing front color                                                                                                           | RAL 9016 white<br>RAL 9011 black (RDG2..KN/BK)                                                                                                                                                                                                                                                                                                                                                                                                                                                                                 |
| Weight without/with packaging<br>RDG200KN / RDG200KN/BK / RDG200T<br>RDG204KN<br>RDG260KN / RDG260KN/BK / RDG260T<br>RDG264KN | 266 g/336 g<br>270.3 g/345.9 g<br>242 g/311 g<br>269.5 g/324.6 g                                                                                                                                                                                                                                                                                                                                                                                                                                                               |
| Reference documentation (RDG2..KN)                                                                                            | Handbook for Home and Building Control - Basic Principles<br>(EN: <a href="https://my.knx.org/shop/product?language=en&amp;product_type_category=books&amp;product_type=handbook">https://my.knx.org/shop/product?language=en&amp;product_type_category=books&amp;product_type=handbook</a><br>DE: <a href="https://my.knx.org/shop/product?language=de&amp;product_type_category=books&amp;product_type=handbook">https://my.knx.org/shop/product?language=de&amp;product_type_category=books&amp;product_type=handbook</a> ) |
| Synco™ (RDG2..KN)                                                                                                             | CE1P3127 Communication via KNX bus for Synco 700, 900 and RXB/RXL<br>Basic documentation                                                                                                                                                                                                                                                                                                                                                                                                                                       |
| Desigo (RDG2..KN)                                                                                                             | CM1Y9775 Desigo RXB integration – S-Mode<br>CM1Y9776 Desigo RXB/RXL integration – individual addressing<br>CM1Y9777 Third-party integration<br>CM1Y9778 Synco integration<br>CM1Y9779 Working with ETS                                                                                                                                                                                                                                                                                                                         |

\*) The documents can be downloaded from <https://hit.sbt.siemens.com>.

# 8 Dimensions

Dimensions in mm

**RDG2..**

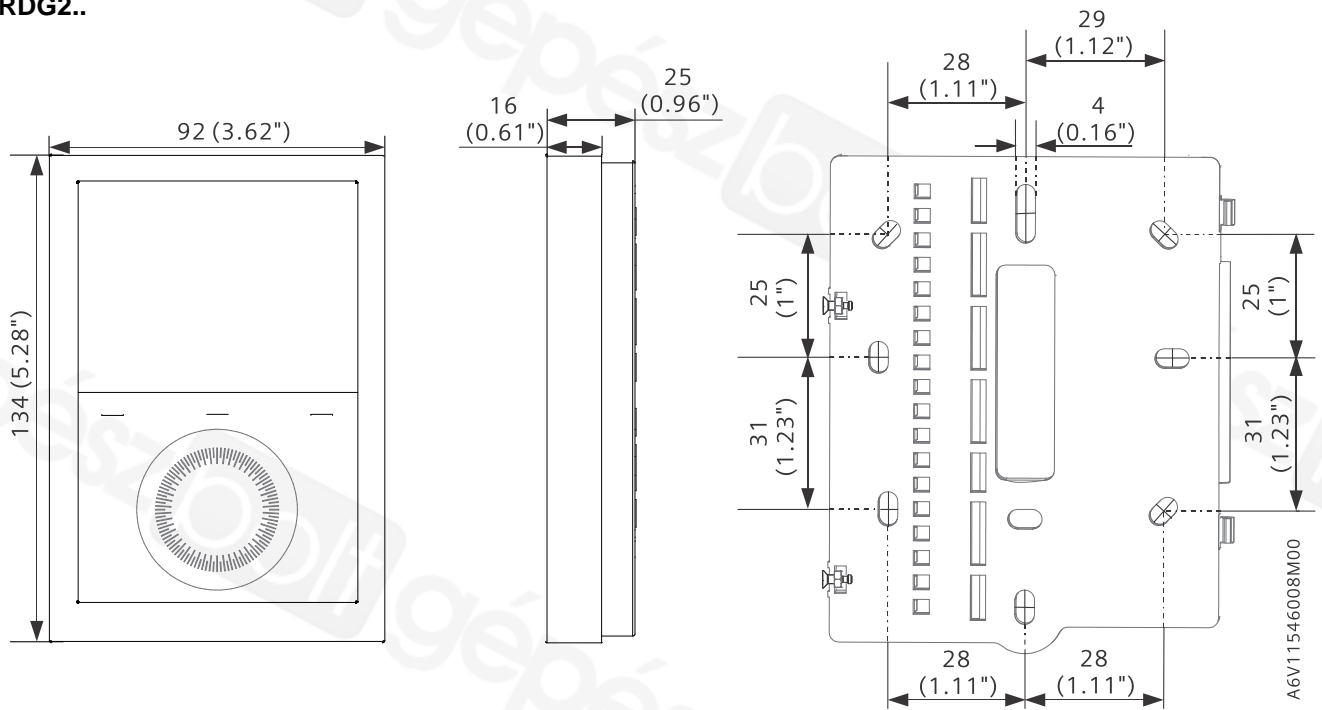

**ARG200**

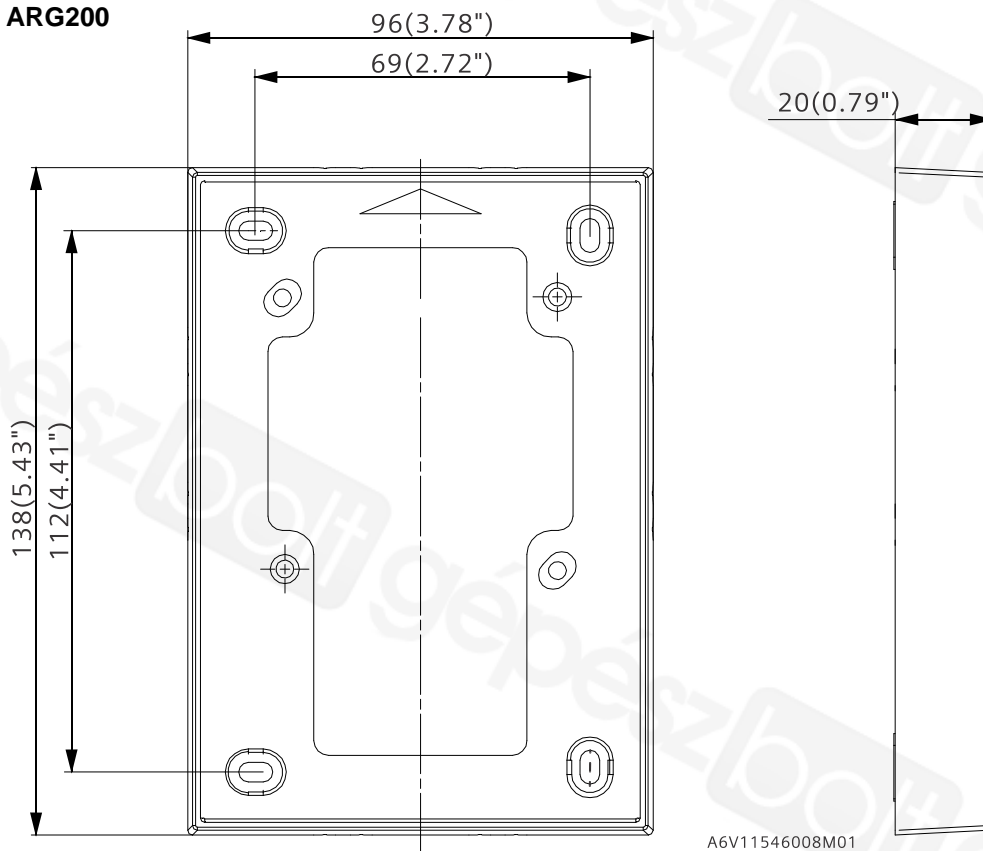

# Index

- 1**  
1-speed ..... 133
- 3**  
3-position control signal ..... 124  
3-speed ..... 133
- A**  
Absolute setpoint ..... 42  
ACS tool ..... 176  
Adaptive temperature compensation ..... 91  
air cooling ..... 78  
Automatic heating/cooling changeover ..... 54, 87
- B**  
Basic application ..... 107  
Bus - setting and adjusting setpoints ..... 42  
Button lock ..... 63
- C**  
Cable length for sensors ..... 140  
Changeover switch ..... 55  
Changeover via KNX ..... 54, 138  
Chilled/heated ceiling applications ..... 107  
Clean fan filter reminder ..... 137  
CO<sub>2</sub> air cooling ..... 6  
Comfort setpoint ..... 40  
Commissioning ..... 42, 163  
Communication objects ..... 141, 154  
Compressor application ..... 108  
Control outputs configuration ..... 129  
Control outputs overview ..... 124  
Control parameters ..... 163  
Control sequences ..... 87  
Cooling demand ..... 150  
Cooling sequence ..... 87
- D**  
DC 0...10 V for electric heaters ..... 126  
DC 0...10 V for valve actuators ..... 126, 127, 128  
Delta temperature control ..... 12, 62  
Desigo ..... 22  
Dewpoint monitoring ..... 61, 139  
digital input ..... 138  
DIP switches ..... 124, 129  
Download via tool ..... 164
- E**  
Economy cooling setpoint ..... 42  
Economy heating setpoint ..... 42  
Electric heater enable/disable ..... 139  
Enable/disable electric heater ..... 91, 105, 139  
Expert level parameters ..... 163  
External/return air temperature ..... 138  
External/return air temperature sensor ..... 55
- F**  
Fan in Auto mode ..... 137  
Fan kick ..... 136  
Fan minimum on- time ..... 136  
Fan operation as per heating/cooling mode, or disabled ..... 136  
Fan overrun ..... 137  
Fan stage in dead zone ..... 136  
Fan start delay ..... 137, 138  
Fan start kick ..... 137  
Fault ..... 139  
Fault handling ..... 141  
Fault on KNX ..... 151  
Floor cooling ..... 58  
Floor heating ..... 58  
Floor temperature limitation function ..... 59  
Flow and return temperature ..... 62  
Flow limitation ..... 60  
Flow temperature ..... 62  
Forced ventilation ..... 6, 79
- G**  
Geographical zone ..... 5, 146  
Green leaf indication ..... 63
- H**  
Heartbeat ..... 150  
Heating and cooling sequence ..... 87  
Heating demand ..... 150  
Heating sequence ..... 87  
Heating/cooling changeover ..... 55, 138  
Heating/cooling changeover via bus ..... 54  
HomeControl app ..... 182  
HumDehumMode ..... 67  
Humidification ..... 67
- I**  
IAQ ..... 78  
Integration via KNX ..... 20

|                                                 |        |
|-------------------------------------------------|--------|
| <b>K</b>                                        |        |
| KNX functions .....                             | 20     |
| KNX LTE-Mode .....                              | 145    |
| KNX overview .....                              | 141    |
| KNX parameters .....                            | 174    |
| KNX S-Mode .....                                | 141    |
| KNX tools .....                                 | 173    |
| <b>L</b>                                        |        |
| Local time of day .....                         | 69     |
| LTE-Mode .....                                  | 145    |
| <b>M</b>                                        |        |
| M/S - manager/subordinate .....                 | 71     |
| manager/subordinate .....                       | 5      |
| Manual heating/cooling changeover .....         | 55     |
| Manually select heating or cooling sequence ... | 87     |
| Minimum output .....                            | 57     |
| Moisture .....                                  | 74     |
| Monitoring with ACS .....                       | 177    |
| Monitoring with OZW772 .....                    | 182    |
| Multifunctional input .....                     | 138    |
| <b>N</b>                                        |        |
| NFC .....                                       | 75     |
| <b>O</b>                                        |        |
| On/Off control signal .....                     | 124    |
| Operation with ACS .....                        | 177    |
| Operation with OZW772 .....                     | 182    |
| OZW772 .....                                    | 182    |
| <b>P</b>                                        |        |
| Parallel connection of switches .....           | 140    |
| Parameter setting in ACS .....                  | 176    |
| Parameter setting in ETS .....                  | 174    |
| Parameter setting via tool .....                | 164    |
| Parameter settings in ACS .....                 | 178    |
| Plant diagram in ACS .....                      | 178    |
| PL-Link .....                                   | 6      |
| Power reserve clock .....                       | 85     |
| Presence detector .....                         | 36     |
| product index .....                             | 5, 6   |
| Purge function .....                            | 57     |
| PWM .....                                       | 124    |
| PWM for electric heater .....                   | 125    |
| <b>R</b>                                        |        |
| Radiator applications .....                     | 107    |
| Read live data .....                            | 185    |
| Remote heating/cooling changeover .....         | 55     |
| Remote operation .....                          | 182    |
| Reset parameters .....                          | 163    |
| Return flow temperature control .....           | 5      |
| Room humidity .....                             | 66     |
| <b>S</b>                                        |        |
| Scheduler .....                                 | 5, 69  |
| Sensor input .....                              | 138    |
| Setpoint Comfort mode .....                     | 122    |
| Setpoint Economy mode .....                     | 122    |
| Setpoint high .....                             | 66     |
| Setpoint low .....                              | 66     |
| Setpoint priority .....                         | 44     |
| Setpoint Protection mode .....                  | 122    |
| Setpoints - setting via bus .....               | 42     |
| Setpoints and sequences .....                   | 122    |
| S-Mode .....                                    | 141    |
| Supply air temperature limitation .....         | 60     |
| Swap function .....                             | 57, 60 |
| Switching off external equipment .....          | 58     |
| Synchronization .....                           | 125    |
| Synco 700 .....                                 | 20     |
| <b>T</b>                                        |        |
| Temperature out of range .....                  | 141    |
| Temporary comfort setpoint .....                | 40     |
| Time of day via bus .....                       | 69     |
| Tool - Parameter setting and download .....     | 164    |
| <b>V</b>                                        |        |
| Valid set of versions .....                     | 173    |
| Valve kick/exercising .....                     | 62     |
| <b>W</b>                                        |        |
| Water flow limitation .....                     | 60     |
| Window contact .....                            | 138    |
| <b>Z</b>                                        |        |
| Zone addressing .....                           | 145    |
| <b>Δ</b>                                        |        |
| ΔT control .....                                | 62     |

Issued by  
Siemens Switzerland Ltd  
Smart Infrastructure  
Global Headquarters  
Theilerstrasse 1a  
CH-6300 Zug  
+41 58 724 2424  
[www.siemens.com/buildingtechnologies](http://www.siemens.com/buildingtechnologies)

© Siemens 2020

Technical specifications and availability subject to change without notice.