

GAMMA instabus

Binary input, 4 x potential-free, 8 x potential-free

N 262D31, N 262D51



Binary input devices with 4 or 8 inputs for potential-free contacts for processing binary signals (signal contacts, door/window contacts).

- Potential-free contacts with internally generated polling voltage for connection to a KNX system
- Clear direct operating level for simulating input states during commissioning without conventional switches, push-buttons or signal contacts connected
- Extensive range of applications for the control of lighting, solar protection, HVAC, signaling of system states and pulse counting
- Maintenance-free terminals for connecting and looping through solid, stranded and conductors

Functions for configuration with ETS:

- Extensive operating and control functions such as switching, dimming, solar protection control, sending different values, scene control, color temperature control, etc.
- Recording and counting pulses with threshold monitoring and difference counting for two neighboring channels
- Simultaneous execution of different functions on one channel by sending an operating command via an additional KNX telegram
- Logic operations per input

Characteristics

Binary inputs serve as an interface for operating KNX systems via potential-free binary signals recorded by conventional switches or push-buttons, for example.

In addition, the binary inputs are used to record switching or system states, fault or alarm signals, or to count pulses.

Binary inputs offer both functions that use just one input channel and functions for which two input channels are required. Which adjacent channels are connected for this purpose can be configured in the device settings.

Depending on the function selected for the input channel, it can be defined whether a telegram is sent on a rising edge and/or falling edge, on a short and/or long press of the push-button or on a change of state.

Potential-free input:

Binary inputs with potential-free inputs:

- Binary input N 262D31, 4 x potential-free 5WG1262-1DB31
- Binary input N 262D51, 8 x potential-free 5WG1262-1DB51

The devices with potential-free input channels are used to detect potential-free contacts. The pulsed polling voltage is generated internally.

The device is a rail-mounted device in N dimension for installation in arrangements and installation on TH 35-mm DIN rails as per standard IEC 60715.

The bus connection of the device uses a bus terminal block. The electronics of the device are supplied via the bus voltage (no additional supply voltage required).

The maintenance-free terminals are designed for the connection of solid or fine-stranded conductors with a conductor cross-section of 0.5 to 2.5 mm² or for the connection of stranded conductors with a conductor cross-section of 2.5 mm². Stranded and fine-stranded conductors can be plugged into the terminals without ferrules.

Direct operating level via membrane keypad with one control button and one status LED per channel. Input states can be simulated via the control buttons. The input states are indicated via red status LEDs.

Functions

Factory settings

In the delivery state, all inputs (channels) are assigned the function "Switching" for the building site function and for direct operation.

Building site function

The building site function provided ex-factory enables switching the building site lighting on and off via a bus wall switch or binary input and a respective actuator, even if these devices have not yet been commissioned with the Engineering Tool Software ETS.

Switching the site lighting on and off via the "Channel state On/Off" push-button on the front of the binary input is also possible.

Programming mode

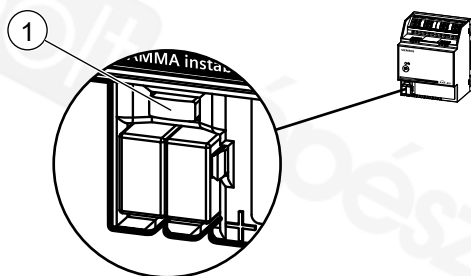

Fig. 1: Programming button and programming LED (example illustration)



After bus voltage recovery, wait several seconds before pushing the programming (1) button (not before booting is complete).

Activate programming mode

- a) Briefly press the programming push-button (1) (< 2 seconds).
- ⇒ Programming mode is activated.
- ⇒ The programming LED (1) illuminates continuously.

Deactivating programming mode

- ✓ Programming mode is activated. The programming LED (1) illuminates continuously.
- a) Briefly press the programming push-button (1) (< 2 seconds).
- ⇒ Programming mode is deactivated.
- ⇒ The programming LED (1) is not illuminated.

Resetting the device to factory settings

A very long push of the programming button of more than 20 seconds resets the device to its factory settings. This is indicated by the programming LED flashing steadily for 8 seconds.

All configuration settings are deleted. The building site function of the delivery state is re-activated.

Behavior on unloading the application program

After unloading the application program with the ETS, the unloaded device has no functions.

Behavior on voltage failure/recovery

The electronics of the device are bus powered. Therefore, a grid voltage failure only leads to a functional failure of the device if the bus voltage also fails as a result of the grid voltage failure.

In the event of bus voltage failure, the current status and other values for each input are permanently saved so that they can be restored when the bus voltage is recovered.

When bus voltage is recovered, the configured actions for each input are configured and, depending on the parameters set, new statuses are reported.

Direct operation

In direct operation, the transmission of the output telegrams can be triggered directly via the push-buttons available at the binary input. This simulates the opening and closing of the contact without the need to physically connect components to the channels or to trigger them.

Each channel of the binary input can be operated via a separate push-button ("Channel state On/Off" push-button).

Factory settings

In the delivery state (see also Building site function [▶ 2]), the function in direct mode is as if the "switching (On/Off)" function had been configured.

See also

📖 Building site function [▶ 2]

Send switching state / binary value

The "Send switching status/binary value" function is used, for example, to query and transmit the switching state of a contact. The binary value "0" or "1" is sent.

Various parameters can be used to set which switching value is sent after a status change, when the switching value is sent, and whether an additional telegram is sent.

Switching

With the "Switching" function, lights or lighting groups can be switched on and off with one push-button in conjunction with an actuator.

The sending of the switching telegram can be triggered by pressing the push-button for a short and/or long time or, alternatively, by a rising and/or falling signal edge (generated by pressing and/or letting go of the button).

Dimming

With the "Dimming" function, lights or lighting groups can be switched on and off and dimmed up and down with one or two push-buttons.

The "Dimming" function can be implemented using the following push-button options. The "1/2 push-button dimming (...)" and "2 push-button dimming" options differ only in terms of connections and programming, but not for the end user. In both cases, the end user has one push-button to turn the lights on and dim them up, and a second push-button to dim the lights down and turn them off.

- 1 push-button dimming
- 1/2 push-button dimming
- 2 push-button dimming

Scene control

With the "Scene control" function, for example, various devices can be set simultaneously to a certain predefined value at the touch of a push-button.

During configuration, a choice can be made between 1-bit scenes and 8-bit scenes.

Solar protection control

With the "Solar protection control" function, solar protection can be raised and lowered with one or two push-buttons. In addition, slats can be opened and closed.

The "Solar protection control" function can be implemented using the following push-button options. The "1/2 push-button solar protection" and "2 button shutter" options differ only in terms of connections and configuration, but not for the end user. In both cases, the end user has a push-button to raise the solar protection and open the slats, and a push-button to lower the solar protection and close the slats.

- 1 push-button solar protection
- 1/2 push-button solar protection
- 2 push-button solar protection

Send value

With the function "Send value" one or two configured values of a defined data type can be sent.

It is possible to set what triggers the sending of the value as well as when which value is sent, e.g. value "A" on a rising edge and value "B" on a falling edge or alternatively on a short and long press of a push-button.

Logic operations

With the function "Logic operations" the input channel physically arriving at the input from a switch or sensor can be linked to one or two further signals received via the bus.

The following logical operators are available for operations:

- AND
- OR
- XOR
- FILTER
- TRIGGER

Pulse counting

With the "Pulse counting" function, pulses arriving at the binary input can be recorded, counted and saved. It is possible to count in the positive as well as in the negative direction.

Difference counting

With the function "Differential counting" two adjacent channels of the binary input are used and configured together.

With difference counting, for example, the telegrams from two sensors are detected, counted and the difference is calculated.

Color temperature control

The "Colour temperature control" function is a 1/2 push-button function in which 2 push-buttons are configured and connected completely separately, one push-button being assigned the "1/2 button dimming On/brighter, warm/warmer" function and the other the "1/2 button dimming Off/darker, cold/colder" function.

With the "Colour temperature control" function, in contrast to the "Dimming" function, the color temperature can be dimmed in addition to the brightness or optionally only the color temperature.

Forced control

With the function "Forced Control" at the binary input, the override function of an actuator can be switched on, off or inactive via a switch. Combinations can also be configured such that, for example, the switching value "Forced off" is sent when the push-button is pressed briefly and the switching value "Inactive" is also sent when the push-button is pressed for a long time.

If the forced control is switched to inactive via the binary input, the binary input does not specify a switching value for forced control, but passes on the regular value to the actuator, where it is further evaluated.

Effect control

The effect control is used to trigger or terminate an effect programmed on another device (e.g. KNX/DALI gateway) with a push-button (or similar) connected to the binary input.

You can define which of 64 possible effects is triggered or terminated. Furthermore, a distinction is made between short and long presses of the push-button.

Group control

With the "Sequenced switching group control" function, for example, 2 or 3 lamps can be switched on and off in succession with a single push-button. Lamp groups can also be switched instead of lamps. The sequence of the circuits is determined via the assigned communication objects and cannot be changed via parameters.

Multiple operation

The function "Multi-touch control" can be used to configure, for example, that different consumers are switched at short intervals when the switch is pressed several times. Pressing the switch once, twice and three times can be assigned the function "toggle," "switch off" or "switch on" respectively.

Technical design

Position and function of the connections and labeling

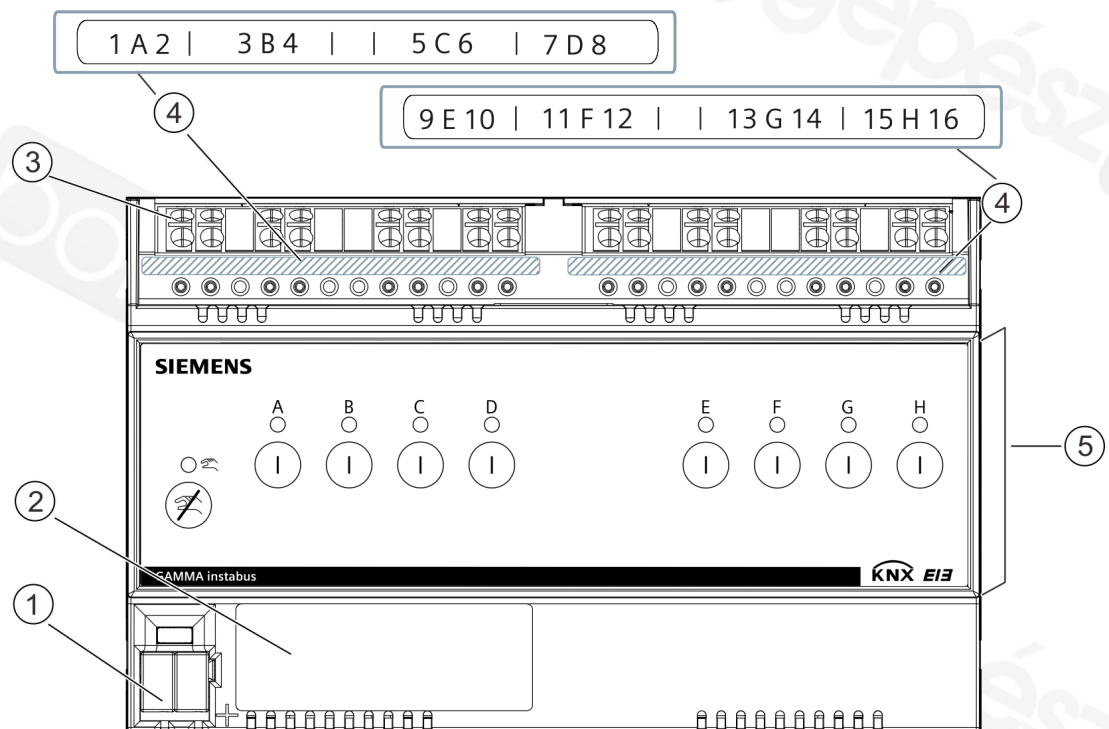

Fig. 2: Position and function of the connections and labeling, example: Binary input 8 x potential-free

Pos.	Element	Function
1	Connection pins for KNX bus terminal block	Connect KNX bus
2	Label field	Enter physical address
3	Terminals of the potential-free binary inputs	Connection of the potential-free binary signals: Push-buttons, switches or contacts
4	Labeling of the potential-free binary inputs for the channels	
5	Membrane keypad	Execute direct operation Display switch status

Position and function of the operating and display elements

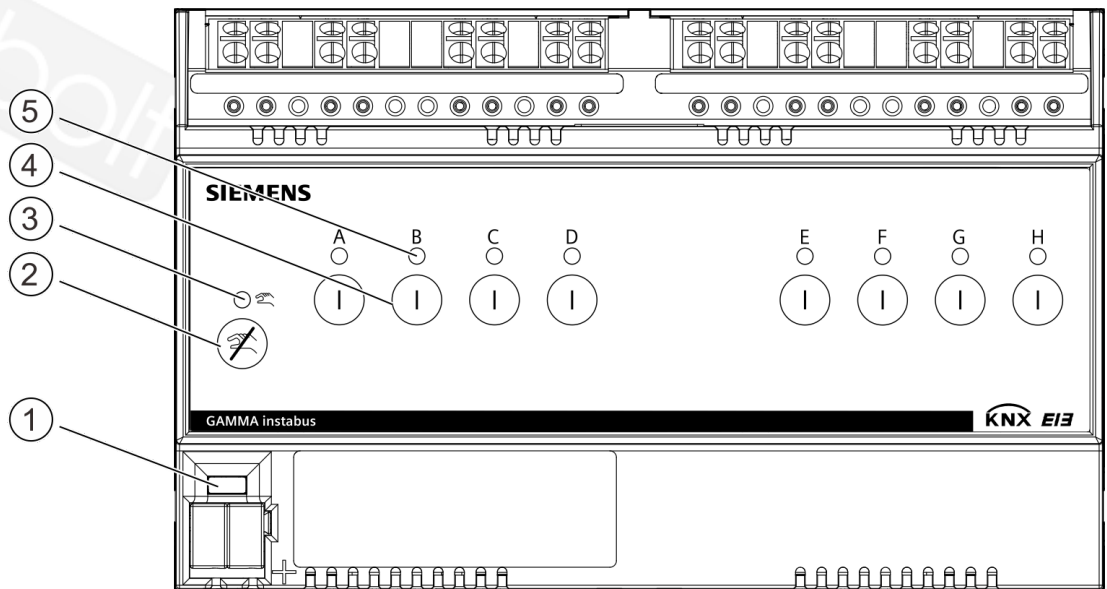



Fig. 3: Control and display elements, example: Binary input 8 x potential-free

Pos.	Operating or display elements	Function
1	Programming LED (red), Programming button	Short push of button (< 2 s): <ul style="list-style-type: none"> Activate programming mode, display status (LED on = active). Very long push of button (> 20 s): <ul style="list-style-type: none"> Reset to factory settings (after 20 s, the LED starts flashing for about 8 s).
2	Button: Deactivate direct operation	Deactivate direct operation for all channels.
3	Status LED of direct operation (yellow)	LED flashes if direct operation is active for at least one channel.
4	Button: Channel state On/Off	Function according to the ETS configuration. In the delivery state, the "switching" function is active. Short or long pressing of push-buttons have a related effect.
5	Status LED of the channel (red)	Indicates the switching state (On/Off) of the respective channel. <ul style="list-style-type: none"> LED switched off: Direct operation is switched off. The contact of the channel is open. LED lit: Direct operation is switched off. The contact of the channel is closed. LED flashes at short intervals: Direct operation is switched on. An open contact is simulated for this channel. LED flashes at long intervals: Direct operation is switched on. A closed contact is simulated for this channel.

Type overview

Type	Description	Article number	KNX PL-Link
	Binary input N 262D31, 4 x potential-free	5WG1262-1DB31	yes
	Binary input N 262D51, 8 x potential-free	5WG1262-1DB51	yes

Version of the Engineering Tool Software

Application	Version
Engineering Tool Software (ETS)	ETS 5 or above

Product documentation

Documents related the product, such as operating and installation instructions, application program description, product database, additional software and CE declarations can be downloaded from the following website:

<http://www.siemens.com/gamma-td>



Frequently asked questions

For frequently asked questions about the product and their solutions, see:

<https://support.industry.siemens.com/cs/products?dtp=FAQ&mfnc=ps&lc=de-WW>



Support

Contact details for additional questions relating to the product:

Tel.: +49 911 895-7222

Fax: +49 911 895-7223

Email: support.automation@siemens.com

<http://www.siemens.com/supportrequest>



⚠ CAUTION**National safety regulations**

Failure to comply with national safety regulations may result in personal injury and property damage.

- Observe national provisions and comply with the appropriate safety regulations.



- Electrical expertise is required for the installation.
- The installation must be performed by a specialist.
- Do not open the casing of the device.
- No DC or AC voltage may be connected to the inputs for connecting the potential-free contacts. This leads to damage or destruction of the input or the device as well as to voltage carry-over to the bus.
- When connecting the potential-free contacts to the terminals, safe isolation from dangerous voltages must be maintained.

Incorrect installation can deactivate electrical safety features without this being apparent to a lay person.

Commissioning**Connection of the contacts to the binary inputs**

Fig. 4: Example graphic: Binary input 8 x potential-free

Cu	
	0.5...2.5 mm ²
	2.5 mm ²



Connecting KNX

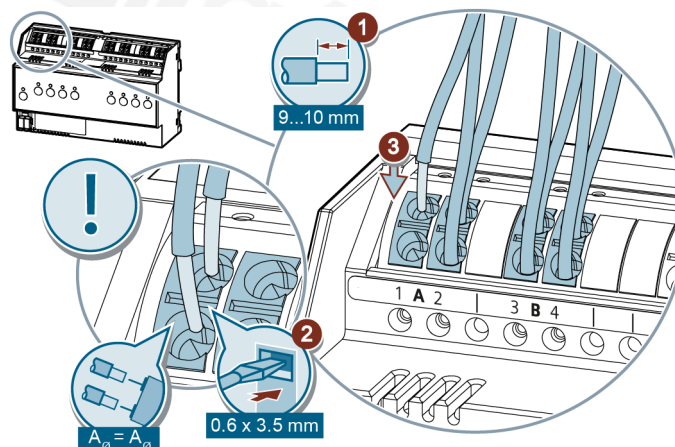
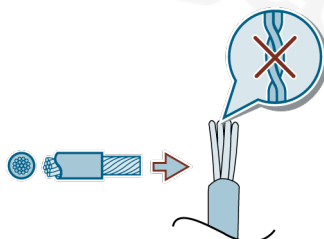
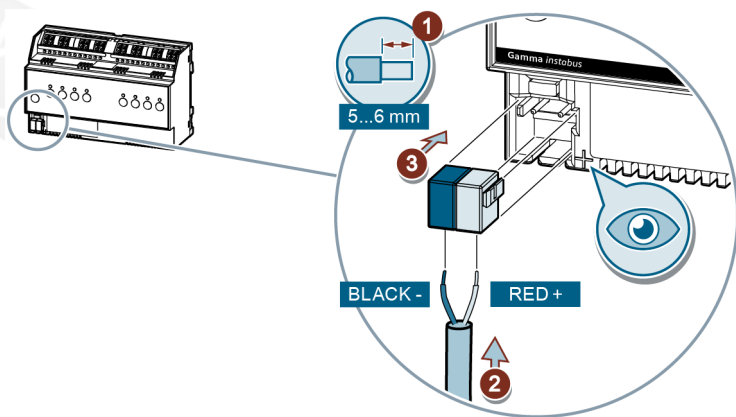



Fig. 5: Example graphic: Binary input 8 x potential-free

Cu	
	0.6...0.8 mm

Test of KNX 24 V DC type SELV

This test can be used to check whether the bus connection cable is connected with the correct polarity and whether device is supplied with bus voltage.

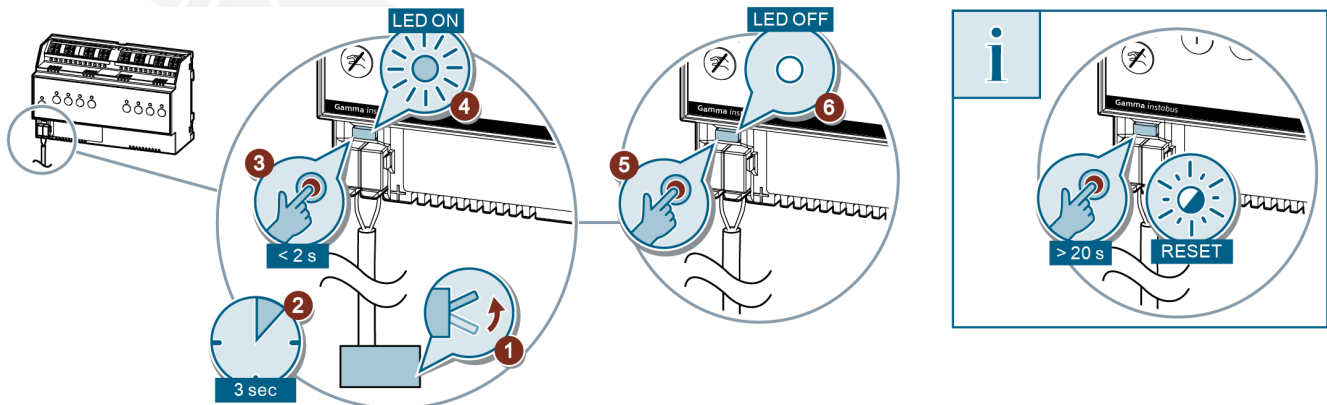

Fig. 6: Example graphic: Binary input 8 x potential-free

A very long push of the programming button of more than 20 seconds resets the device to its factory settings.

Operation in direct operation (A|B|C|D|E|F|G|H)

This test can be used to simulate input states by operating the relevant channel push-buttons. This allows the system to be tested without wiring on the potential-free input.

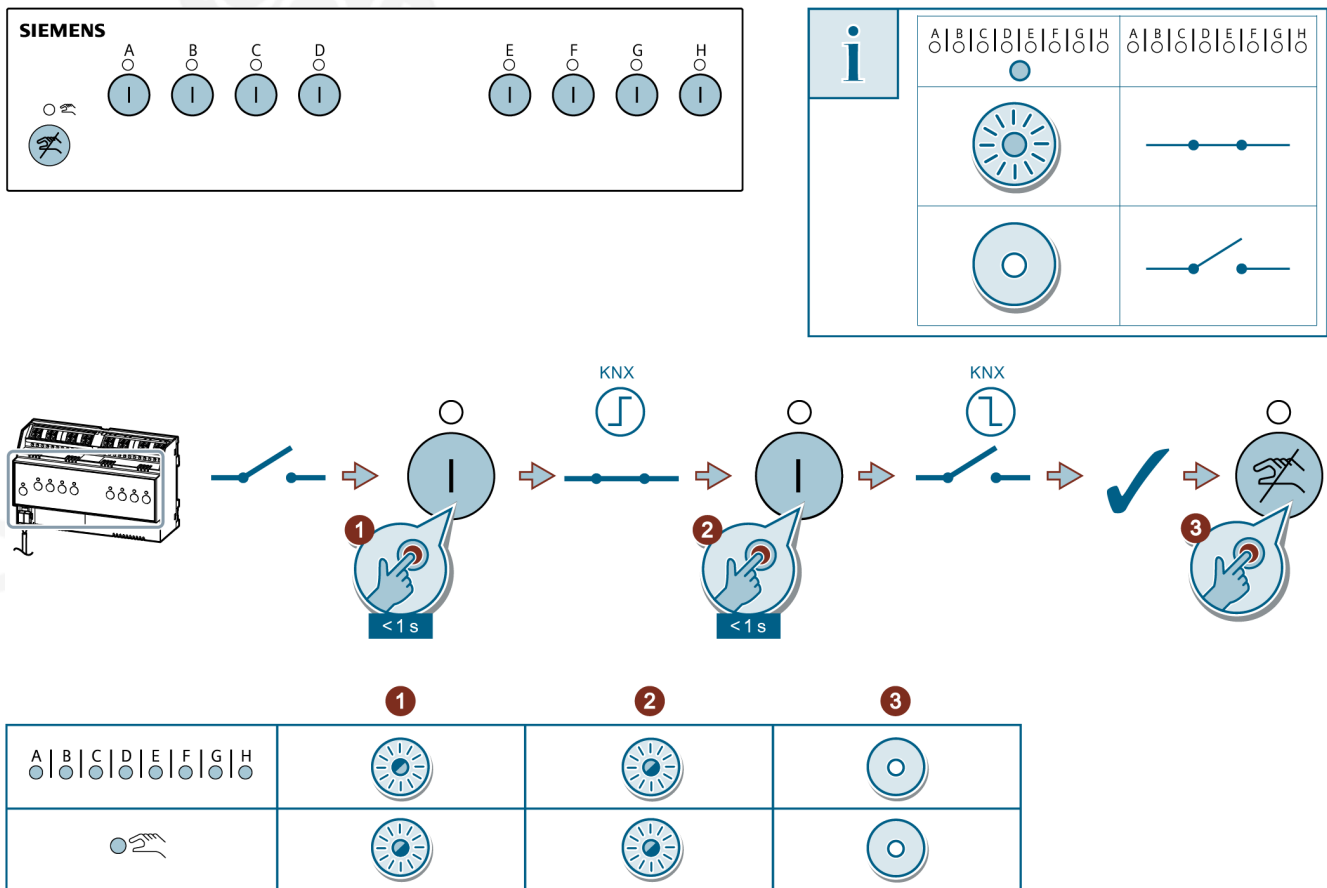

Fig. 7: Example graphic: Binary input 8 x potential-free

Disposal



The device is considered an electronic device for disposal in accordance with European Directive and may not be disposed of as domestic waste.

- Use only designated channels for disposing the devices.
- Comply with all local and currently applicable laws and regulations.

Technical data

Power supply	N 262D31	N 262D51
KNX bus voltage	DC 24 V (DC 21...30 V)	DC 24 V (DC 21...30 V)
KNX bus current	9.5 mA	12.5 mA
Power loss (internal consumption)	0.2 W	0.3 W

Inputs for potential-free contacts	N 262D31	N 262D51
Number of inputs	4	8

Determining the switching state of a potential-free contact connected to an input via voltage pulses generated in the device:

Pulse voltage if contact is open:	20 Vss
Pulse current if contact is closed:	0.66 Ass

Input signal delay until first bus telegram

After the contact is closed:	60 ms
After the contact is opened:	60 ms
Contact ON time:	100 ms
Contact OFF time	100 ms
Debounce time (configurable)	Min. (= from) 30 ms
	Max. (= to) 300 ms
Max. detectable switching frequency:	5 Hz
Max. length of connecting lines with pairs of twisted cables:	100 m
Max. length NYM connection cable:	100 m

Power loss	N 262D31	N 262D51
Maximum device power loss	0.25 W	0.35 W

Mechanical data	N 262D31	N 262D51
Housing material	Plastic	Plastic
Dimensions	4 HP (1 HP = 18 mm) Dimensions [▶ 16]	8 HP (1 HP = 18 mm) Dimensions [▶ 16]
Weight (device)	140 g	250 g
Fire load	4 MJ	6 MJ

Environmental conditions

Environmental category (as per EN 60721-3-3)	Class 3k5
Ambient temperature in operation	-5 °C...+45 °C (23 °F...113 °F)
Storage temperature	-20 °C...+70 °C (-4 °F...158 °F)
Transport temperature	-25 °C...+70 °C (-13 °F...158 °F)
Relative humidity (non-condensing)	5 %...95 %

Protection settings	
Degree of pollution (according to IEC 60664-1)	2
Overtoltage category (according to IEC 60664-1)	III
Protection type IP	IP20
Electrical safety, bus	Yes
Electrical safety, device complies with	EN 50428
EMC requirements, device complies with	EN 50428

Test mark	
CE marking	Yes
KNX approval mark	Yes
UL approval mark	No
EAC marking	Yes
RCM marking	Yes

Reliability	N 262D31	N 262D51
Failure rate (at 40°C)	341 fit	565 fit

Connection example

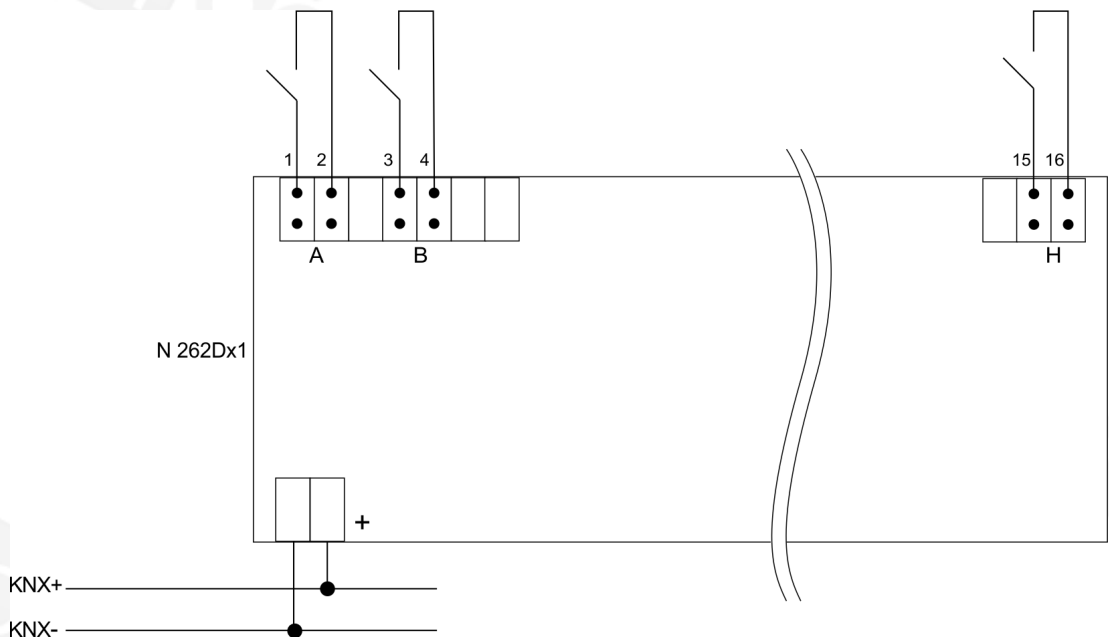

Fig. 8: Connection example 8 potential-free binary inputs

Dimensions

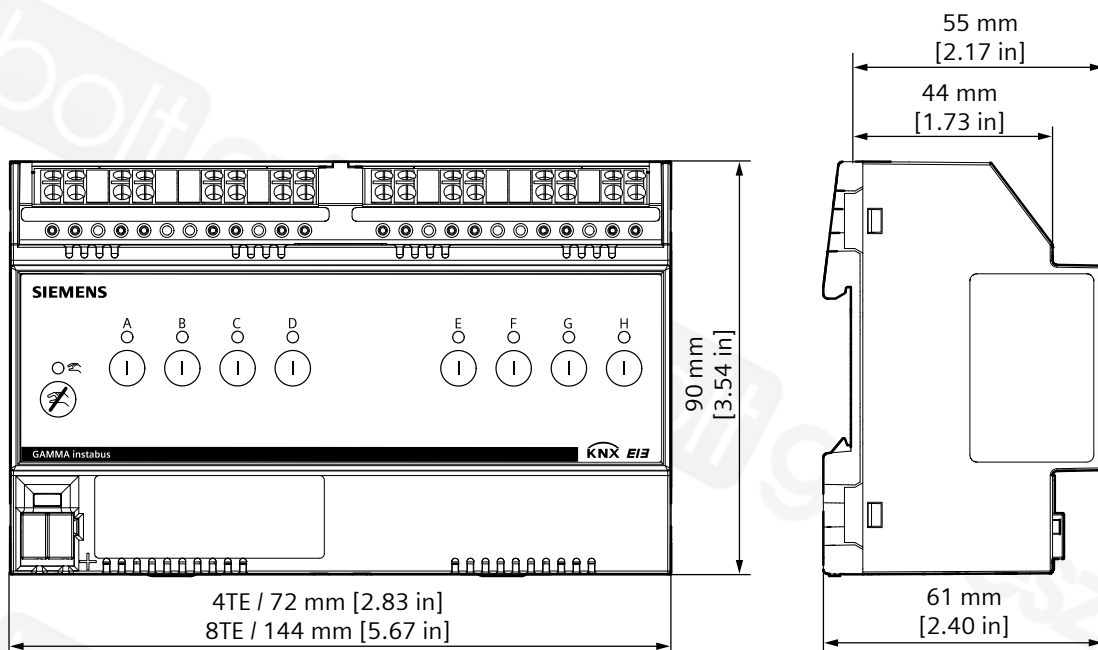

Fig. 9: Dimensions, example: Binary input 8 x potential-free