

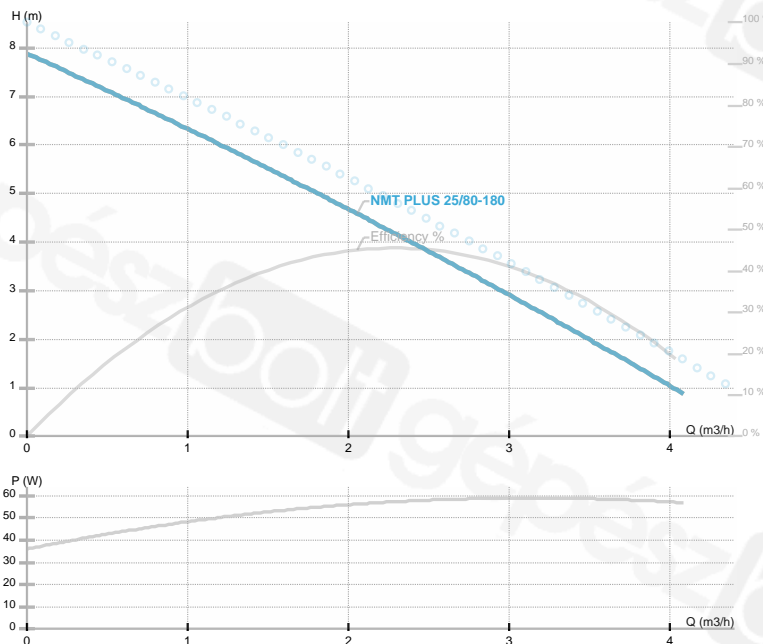

NMT PLUS 25/80-180

NMT SAN small / Electronically regulated threaded pumps for circulation of sanitary water
 Heating, Climatisation



Part number	979523856
Power supply	1~230 V
Declared protection	IP44
Q max	3.46 [m³/h]
H max	7.66 [m]
RPM	4800 [1/min]
Motor power	57 [w]
Declared current	0.5 [A]
Fluid	Water VDI 2035, glycol 40%
Fluid temperature	-10.0 ÷ 110.0 [°C]
Insulation class	F
DN	25 [mm]
Connector	
Net weight	2.39 [kg]
Length	180 [mm]
Approvals	CE EAC
EEL	0.2
Efficiency	36.09 [%]
Impeller material	Noryl 1630V
Bearing material	Ceramics
Shaft material	Ceramics
Hydraulics material	Gray cast iron
Mains frequency	50 Hz
Connection	
Max pressure	1.0 MPa
Ambient temp.range	40 deg C

Dimension drawing

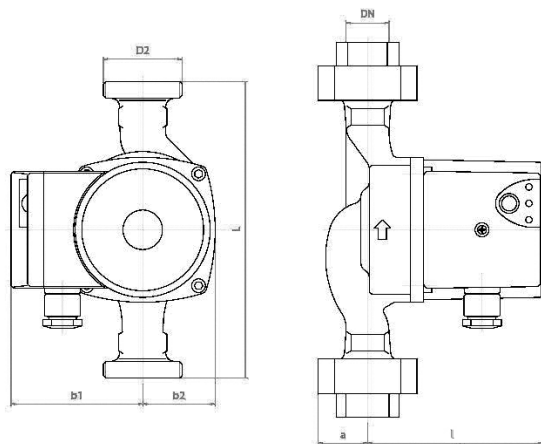

L=180 DN=25 b1=80 b2=48 l=108 a=32 D2=6/4

Electrical wiring

