



SERIES ATA200



Series ATA212
Series ATA222

PED 2014/68/EU, article 4.3

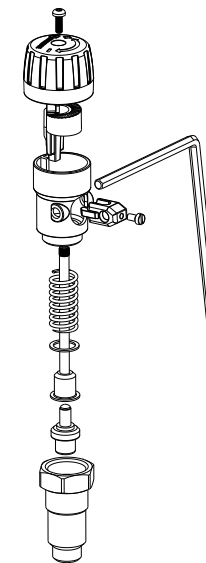
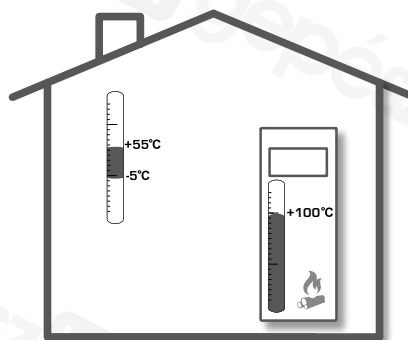

Mtrl.nr: 9814 04 10 • Ritn.nr: 9222 utg B • Rev. 1611

1

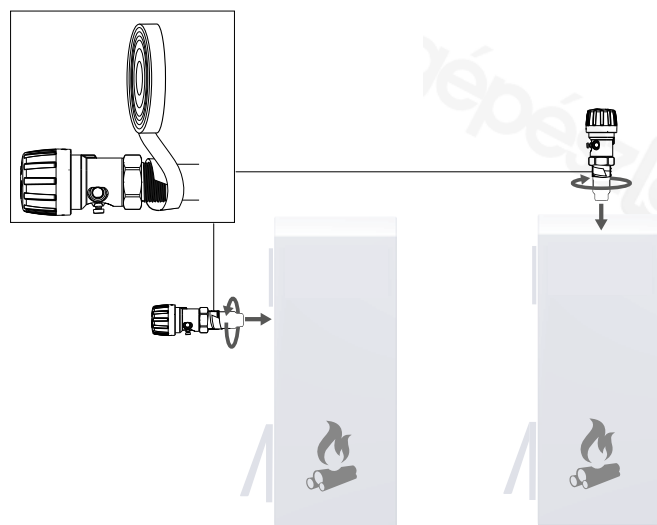

2

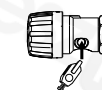
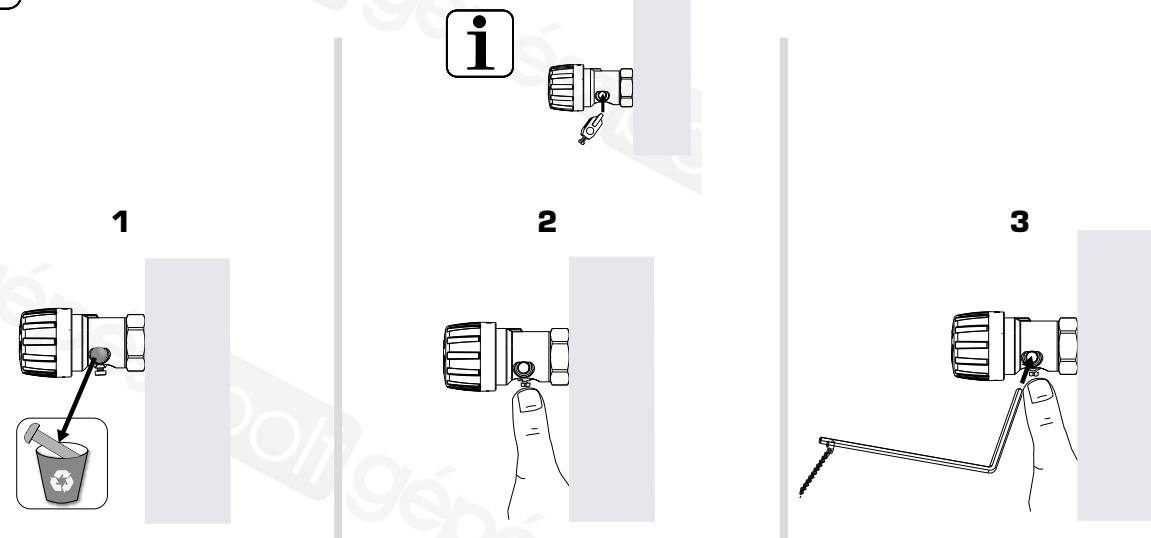

1

2

3

3

ATA200: Min 35°C/Min 60°C

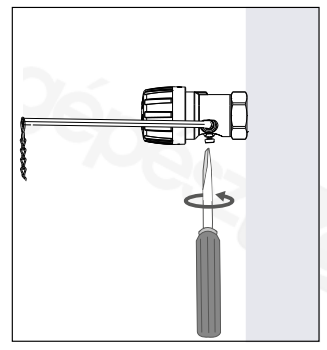
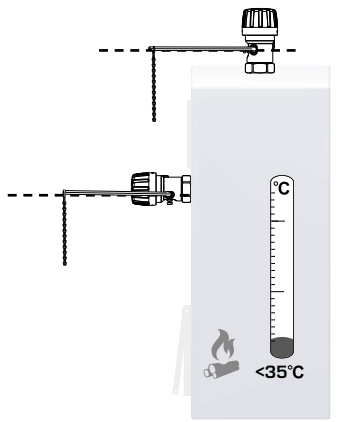
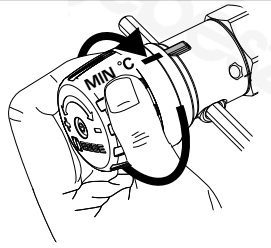

4

°C MAX ?

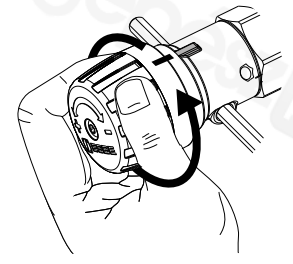

5

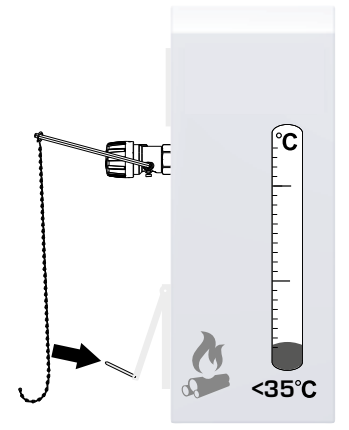

6

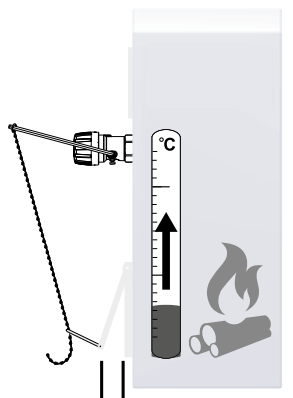

⚠ ≠ 0mm

7

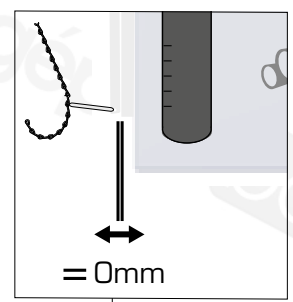
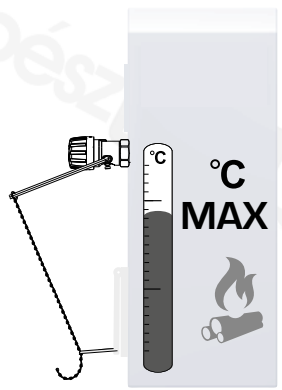

i

≠ 0mm

